

Bylaw No. 500

REGIONAL DISTRICT of NANAIMO
LAND USE AND SUBDIVISION BYLAW NO. 500, 1987

PLANNING DEPARTMENT
6300 HAMMOND BAY ROAD
NANAIMO, BC V9T 6N2

CONSOLIDATED: December 2018

*Telephone: 250-390-6510
Toll Free: 1-877-607-4111
Fax: 250-390-7511
Email: planning@rdn.bc.ca
Web: www.rdn.bc.ca*



REGIONAL
DISTRICT
OF NANAIMO

Regional District of Nanaimo

Bylaw No. 500

Table of Contents

SCHEDULE 'A'

PART 1 ADMINISTRATION.....1-1

- 1.1 Enactment1-4
- 1.2 Other Legislation1-5
- 1.3 General Prohibition1-5
- 1.4 Inspection1-5
- 1.5 Violation1-6
- 1.6 Penalty1-6
- 1.7 Severability1-6

PART 2 INTERPRETATION.....2-1

- 2.1 Definitions2-3

PART 3 LAND USE REGULATIONS3-1

- 3.1 Zones.....3-2
- 3.2 General Operative Clauses3-5
- 3.3 General Regulations3-6
- 3.4 Regulations for Each Zone3-22
 - Section 3.4.1 Agriculture 1 Zone 3-23
 - Section 3.4.2 Agriculture 2 Zone 3-27
 - Section 3.4.11 Commercial 1 Zone3-29
 - Section 3.4.12 Commercial 2 Zone3-29
 - Section 3.4.12.1 Commercial 2.1 Zone3-31
 - Section 3.4.13 Commercial 3 Zone3-33
 - Section 3.4.14 Commercial 4 Zone3-34
 - Section 3.4.15 Commercial 5 Zone3-35
 - Section 3.4.16 Commercial 6 Zone 3-37
 - Section 3.4.17 Commercial 7 Zone3-39
 - Section 3.4.18 Resort Commercial Zone.....3-40
 - Section 3.4.19 Commercial 8 Zone3-42
 - Section 3.4.21 Conservation 1 Zone3-44
 - Section 3.4.31 Industrial 1 Zone3-45
 - Section 3.4.32 Industrial 2 Zone3-46

PART 3 LAND USE REGULATIONS continued

Section 3.4.33 Industrial 3 Zone 3-47

Section 3.4.34 Industrial 4 Zone 3-48

Section 3.4.35 Industrial 5 Zone 3-49

Section 3.4.41 Public 1 Zone 3-50

Section 3.4.42 Public 2 Zone 3-55

Section 3.4.43 Public 3 Zone 3-53

Section 3.4.44 Public 4 Zone 3-54

Section 3.4.46 Public 6 Zone 3-55

Section 3.4.51 Recreation 1 Zone 3-56

Section 3.4.52 Recreation 2 Zone 3-57

Section 3.4.53 Recreation 3 Zone 3-58

Section 3.4.54 Recreation 4 Zone 3-59

Section 3.4.55 Recreation 5 Zone 3-60

Section 3.4.56 Recreation 6 Zone 3-62

Section 3.4.61 Residential 1 Zone 3-63

Section 3.4.61.1 Residential 1.1 Zone 3-64

Section 3.4.61.3 Residential 1.2 Zone 3-65

Section 3.4.62 Residential 2 Zone 3-66

Section 3.4.62.1 Residential 2.1 Zone 3-67

Section 3.4.62.2 Residential 2.2 Zone 3-68

Section 3.4.63 Residential 3 Zone 3-69

Section 3.4.64 Residential 4 Zone 3-70

Section 3.4.65 Residential 5 Zone 3-71

Section 3.4.66 Residential 6 Zone 3-72

Section 3.4.67 Residential 7 Zone 3-73

Section 3.4.68 Residential 8 Zone 3-74

Section 3.4.71 Resource Management 1 Zone 3-75

Section 3.4.72 Resource Management 2 Zone 3-77

Section 3.4.73 Resource Management 3 Zone 3-78

Section 3.4.74 Resource Management 4 Zone 3-79

Section 3.4.75 Resource Management 5 Zone 3-80

Section 3.4.76 Resource Management 6 Zone 3-81

Section 3.4.77 Resource Management 7 Zone 3-82

Section 3.4.78 Resource Management 8 Zone 3-84

Section 3.4.79 Resource Management 9 Zone 3-85

Section 3.4.81 Rural 1 Zone 3-87

Section 3.4.81.1 Rural 1.1 Zone 3-89

Section 3.4.82 Rural 2 Zone 3-91

Section 3.4.83 Rural 3 Zone 3-93

Section 3.4.84 Rural 4 Zone 3-94

Section 3.4.85 Rural 5 Zone 3-95

Section 3.4.86 Rural 6 Zone 3-96

Section 3.4.87 Rural 7 Zone 3-97

Section 3.4.88 Rural 8 Zone 3-98

Section 3.4.89 Rural 9 Zone 3-100

Section 3.4.810 Rural 10 Zone 3-101

Section 3.4.91 Water 1 Zone 3-103

Section 3.4.92 Water 2 Zone 3-104

PART 3 LAND USE REGULATIONS continued

Section 3.4.93 Water 3 Zone.....	3-105
Section 3.4.94 Water 4 Zone.....	3-106
Section 3.4.103 Schooner House Comprehensive Development Zone 4	3-107
Section 3.4.104 Wembley Comprehensive Development Zone 5	3-108
Section 3.4.105 Bowser Village Comprehensive Development Zone 6.....	3-109
Section 3.4.106 Fairwinds Comprehensive Development Zone 8	3-110
Section 3.4.107 Horne Lake Comprehensive Development Zone 9	3-113
Section 3.4.108 South Wellington Comprehensive Development Zone 10.....	3-121
Section 3.4.109 South Wellington 2 Comprehensive Development Zone 11.....	3-123
Section 3.4.111 Rondalyn Resort Comprehensive Development 13	3-125
Section 3.4.112 Englishman River (Block 564) Comprehensive Development Zone 14	3-128
Section 3.4.113 Kipp Road Industrial Comprehensive Development Zone 15	3-133
Section 3.4.117 Comprehensive Development Zone 17 (NCID)	3-136
Section 3.4.118 Schoolhouse Road Light Industrial Comprehensive Development Zone 18	3-139
Section 3.4.119 Midora Road Comprehensive Development Zone 19.....	3-142
Section 3.4.120 Parklands Mobile Home Park Comprehensive Development Zone 20	3-144
Section 3.4.121 Comprehensive Development Zone 21 (Doumont).....	3-148
Section 3.4.124 Horne Lake Regional Park Comprehensive Development Zone 24	3-150
Section 3.4.126 Claudet Road Rural Comprehensive Development Zone 26	3-157
Section 3.4.128 South Wellington Light Industrial Comprehensive Development Zone 28	3-160
Section 3.4.129 Cedar Estates Comprehensive Development Zone 29.....	3-164
Section 3.4.130 Nanoose Bay Village Centre Comprehensive Development Zone 30.....	3-169
Section 3.4.132 Horne Lake Road Comprehensive Development Zone 32	3-177
Section 3.4.133 Schoolhouse and Harold Roads Light Industrial Comprehensive Development Zone 33	3-180
Section 3.4.134 Ridge Town Homes Comprehensive Development Zone 34	3-184
Section 3.4.135 Rockcliffe Comprehensive Development Zone 35	3-187
Section 3.4.136 1680 Timberlands Comprehensive Development Zone 36.....	3-190
Section 3.4.137 Main Road Light Industrial Comprehensive Development Zone 37	3-194
Section 3.4.141 Qualicum Bay Seniors Development Comprehensive Development Zone 41	3-198
Section 3.4.142 Crown and Anchor Campground Comprehensive Development Zone 42	3-200

PART 3 LAND USE REGULATIONS continued

Section 3.4.143 Schooner Bay Manor Seniors Mobile Home Park
 Comprehensive Development Zone 43 3.202
 Section 3.4.144 Lakes District Comprehensive Development Zone 44 3.204
 Section 3.4.144 Schooner Cove Comprehensive Development Zone 45 3.223
 Section 3.4.149 Fielding Road Light Industrial Comprehensive Development Zone 49 3.236
 Section 3.4.150 Beck Road Comprehensive Development Zone 50 3.238
 Section 3.4.151 Comprehensive Development Zone 51 3.240
 Section 3.4.152 Lighthouse Villa Comprehensive Development Zone 52 3.241

SCHEDULE '3A' Zoning Maps 3A-11
 SCHEDULE '3B' Off Street Parking & Loading Spaces 3B-1
 SCHEDULE '3C' Campground Regulations and Standards 3C-1
 SCHEDULE '3D' Residential Mobile Home Park Regulations and Standards 3D-1
 SCHEDULE '3E' Setbacks from Watercourses 3E-1
 SCHEDULE '3F' Landscaping Regulations and Standards 3F-1

PART 4 - SUBDIVISION REGULATIONS 4-1

4.1 Subdivision Districts 4-2
 4.2 Prohibition 4-2
 4.3 Parcel Size 4-2
 4.4 Parcels Exempt for Minimum Parcel Size Requirements 4-3
 4.5 Parcel Shape and Dimensions 4-3
 4.6 Highway Requirements 4-4
 4.7 Sewage Disposal 4-4
 4.8 Water Supply 4-4
 4.9 Exception 4-5

SCHEDULE '4A' Subdivision District Maps 4A-1
 SCHEDULE '4B' Subdivision Districts 4B-1
 SCHEDULE '4C' Community Water System Standards 4C-1
 SCHEDULE '4C1' Lakes District and Schooner Cove Community Water System Standards 4C1-W1
 SCHEDULE '4D' Community Sewer System Standards 4D-1
 SCHEDULE '4D1' Lakes District and Schooner Cove Community Sewer System Standards 4D1-S1

PART 5 – DEVELOPMENT PERMIT AREAS

5.1 Development Permit Area Organization 5-3
 Section 5.1.1 Freshwater and Fish Habitat Development Permit Area 5-4
 Section 5.1.2 Sensitive Ecosystems Development Permit Area 5-11

Section 5.1.3 Eagle and Heron Nesting Trees Development Permit Area5-16

Section 5.1.4 Aquifers Development Permit Area 5-19

Section 5.1.5 Marine Coast Development Permit Area 5-23

Section 5.1.6 Hazard Lands Development Permit Area 5-29

Section 5.1.7 Farmland Protection Development Permit Area 5-33

Section 5.1.8 Yellow Point Aquifer Development Permit Area -36

Section 5.1.9 South Wellington Commercial – Industrial Development Permit Area5-40

Section 5.1.10 Cedar Main Street Development Permit Area 5-44

Section 5.1.11 Cassidy Development Permit Area 5-57

Section 5.1.12 Cedar Development Permit Area 5-61

Section 5.1.13 Extension Village Centre – Commercial Development Permit Area5-65

Section 5.1.14 East Wellington – Pleasant Valley Industrial Development Permit Area5-67

Section 5.1.15 Nanoose Bay Form and Character Development Permit Area5-68

Section 5.1.16 Qualicum Bay and Dunsmuir Village Centres Development Permit Area5-70

Section 5.1.17 Bowser Village Centre Development Permit Area5-76

Section 5.1.18 Multi Residential, Intensive Residential, Industrial and Commercial
 Form and Character Development Permit Area5-87

Section 5.1.19 Rural Commercial Development Permit Area5-92

Section 5.1.20 Highway Corridor Protection Development Permit Area5-95

Section 5.1.21 Inland Island Highway Corridor Development Permit Area5-96

REGIONAL DISTRICT OF NANAIMO

LAND USE AND SUBDIVISION BYLAW NO. 500

REGIONAL DISTRICT OF NANAIMO

BYLAW NO. 500

PART 1

ADMINISTRATION

PART 1 ADMINISTRATION

1.1 Enactment

- 1) Part 3 of this Bylaw shall be deemed to be a zoning bylaw pursuant to Section 903 of the **Local Government Act** and amendments thereto.
- 2) Schedules '3C' and '3D' of this Bylaw are enacted pursuant to Section 903 and 694 of the **Local Government Act** and amendments thereto.
- 3) Schedule '3F' of this Bylaw is enacted pursuant to Section 909 of the **Local Government Act** and amendments thereto.¹
- 4) Part 4 of this Bylaw shall be deemed to be a subdivision bylaw pursuant to Sections 938 and 946 of the **Local Government Act** and amendments thereto.
- 5) For the purpose of this Bylaw, the schedules referred to herein are attached hereto and form an integral part of this Bylaw.
- 6) The following Bylaws are hereby repealed upon adoption of this Bylaw:
 - a) Subdivision and Zoning Regulations adopted by the Regional District of Nanaimo under the provisions of Order-in-Council No. 2929/70 and amendments thereto;
 - b) Greater Nanaimo Advisory Planning Commission Bylaw No. 25, 1970;
 - c) Regional District of Nanaimo Board of Variance Bylaw No. 26, 1970, and amendments thereto;
 - d) Nanoose Bay Advisory Planning Commission Bylaw No. 33, 1971, and amendments thereto;
 - e) Parksville-Qualicum Advisory Planning Commission Bylaw No. 35, 1971, and amendments thereto;
 - f) Deep Bay-Little Qualicum Advisory Planning Commission Bylaw No. 36, 1971;
 - g) South Nanaimo Advisory Planning Commission Bylaw No. 48, 1971, and amendments thereto;
 - h) Regional District of Nanaimo Zoning Bylaw No. 53, 1973, and amendments thereto;
 - i) Regional District of Nanaimo Zoning Bylaw No. 55, 1972, and amendments thereto;
 - j) Untidy and Unsightly Premises Bylaw No. 62, 1972, and amendments thereto;
 - k) Cedar Advisory Planning Commission Bylaw No. 65, 1972;
 - l) Cranberry-Bright Advisory Planning Commission Bylaw No. 66, 1972, and amendments thereto;
 - m) Untidy and Unsightly Premises Bylaw No. 70, 1972;
 - n) Zoning Bylaw Notice Authorization Bylaw No. 106, 1973;
 - o) Untidy and Unsightly Premises Bylaw No. 108, 1973;
 - p) Regional District of Nanaimo Zoning Bylaw No. 159, 1974, and amendments thereto;
 - q) Nanoose Bay Advisory Planning Commission Boundary Amendment Bylaw No. 167, 1974;
 - r) Shaw Hill-Deep Bay Advisory Planning Commission Bylaw No. 170, 1974, and amendments thereto;

¹ Bylaw No. 500.20 – adopted June 18, 1991

- s) Regional District of Nanaimo Zoning Bylaw No. 178, 1975, and amendments thereto;
- t) Lantzville Planning Commission Bylaw No. 200, 1975, and amendments thereto;
- u) Regional District of Nanaimo Zoning Bylaw No. 203, 1975, and amendments thereto;
- v) Untidy and Unsightly Premises Bylaw No. 242, 1976, and amendments thereto;
- w) Regional District of Nanaimo Zoning Bylaw No. 260, 1976, and amendments thereto;
- x) Gabriola Island Planning Establishment Bylaw No. 295, 1976;
- y) Regional District of Nanaimo Zoning and Subdivision Bylaw No. 395, 1981 and amendments thereto;
- z) Regional District of Nanaimo Zoning Consolidation and Subdivision Bylaw No. 444, 1980, and amendments thereto;
- aa) Regional District of Nanaimo Land Use and Subdivision Bylaw No. 500, 1984, and amendments thereto;
- bb) Regional District of Nanaimo Mobile Home Parks Bylaw No. 502, 1979;
- cc) Regional District of Nanaimo Rezoning Application Fee Bylaw No. 527, 1981;
- dd) Regional District of Nanaimo Advisory Planning Commission Bylaw No. 588, 1982.

1.2 Other Legislation

- 1) Nothing contained in this Bylaw shall relieve any person from the responsibility to seek out and comply with other legislation applicable to their undertaking.
- 2) Where land is within an agricultural land reserve created pursuant to the ***Agricultural Land Commission Act*** and amendments thereto and if any portion of this Bylaw is in any way contrary to, in conflict with, inconsistent with or repugnant to the ***Act***, the ***Act*** shall prevail.

1.3 General Prohibition

No person shall:

- a) cause, suffer or permit any building or structure to be used, located, constructed, altered, moved or extended;
- b) use any building or structure constructed, moved or altered;
- c) cause, suffer or permit land to be used;
- d) use land;
- e) subdivide land;
- f) use land without providing off-street parking and loading spaces;

in contravention of this Bylaw or otherwise fail to comply with the requirements of this Bylaw.

1.4 Inspection

The Planning Director and his deputies may enter, at all reasonable times, upon any land subject to the regulations of this Bylaw, to ascertain whether such regulations are being obeyed, provided that:

- a) consent to inspect the land has been obtained from the owner or occupier of the land; or

- b) where such consent has been refused, notice of the intent to inspect has been given to the owner or occupier no less than 24 hours prior to the time of inspection.

1.5 Violation

Any person who violates any of the provisions of this Bylaw or who suffers or permits any act or thing to be done in contravention of this Bylaw or who neglects to do or refrains from doing any act or thing which is required to be done by any of the provisions of this Bylaw, shall be deemed to have violated the provisions of this Bylaw.

1.6 Penalty

Any person who violates any of the provisions of this Bylaw shall, upon summary conviction thereof, be liable to a penalty of not more than \$2,000.00.

1.7 Severability

If any section, subsection, sentence, clause or phrase of this Bylaw is for any reason held to be invalid by the decision of any court, such section subsection, sentence, clause or phrase may be severed from the remaining portion of this Bylaw.

REGIONAL DISTRICT OF NANAIMO

BYLAW NO. 500

PART 2

INTERPRETATION

PART 2 INTERPRETATION

2.1 Definitions

In this Bylaw unless the context otherwise requires:

accessory building means a building or structure located on a parcel, the use of which is accessory to the principal permitted use of the land, buildings or structures located on the same parcel, and includes buildings or structures used for storage or work space by the occupants of the property, but specifically excludes buildings used for residential use;

accessory to means combined with but customarily incidental to;

accessory use means a use combined with but clearly incidental and ancillary to the principal permitted uses of land, buildings or structures located on the same parcel;

agriculture means a use providing for the growing, rearing, producing and harvesting of trees and shrubs; housing livestock, poultry, fur-bearing animals, bees; animal feeding and holding areas; storage crops; and the processing and sale of the primary agricultural products harvested, reared or produced on that farm, including the rough sawing of logs, but excludes animal care, and the following uses on lands that are not in the Agricultural Land Reserve: fur farm, mushroom farm, intensive swine operation, feedlot and cannabis production and specifically excludes horse boarding stable on land located within the Resource Management 3 (RM3) and Rural 5 (RU5) zones^{1 2 3}

agriculture education and research means the use of land, buildings, or structures dedicated to researching, promoting, and teaching methods of agriculture and farming in accordance with the *Agricultural Land Reserve Use, Subdivision and Procedure Regulation*, but specifically excludes schools under the *School Act*;⁴

agri-tourism means an activity, or a service that is ancillary to an activity referred to in the definition of *agri-tourism on a farm* that is carried out on land that is classified as a farm under the *Assessment Act*, to which members of the public are ordinarily invited, with or without a fee, and in connection with which permanent facilities are not constructed or erected;^{5 6}

agri-tourism accommodation means the provision of temporary and seasonal accommodation accessory to an agricultural use for the travelling public within an agri-tourism accommodation sleeping unit on land that is classified as farm under the *Assessment Act*.⁷

agri-tourism accommodation sleeping unit means a bedroom or other area used as a bedroom for the purpose of agri-tourism accommodation within an agri-tourism accommodation cabin, a tent or recreational vehicle in an agri-tourism accommodation campground or a bedroom within a dwelling unit.⁸

¹ Bylaw No. 500.415, adopted March 27, 2018

² Bylaw No. 500.218, adopted August 12, 1997

³ Bylaw No. 500.402, adopted June 28, 2016

⁴ Bylaw No. 500.402, adopted June 28, 2016

⁵ Bylaw No. 500.383, adopted June 25, 2013

⁶ Bylaw No. 500.413, adopted May 22, 2018

⁷ Bylaw No. 500.383, adopted June 25, 2013

⁸ Bylaw No. 500.383, adopted June 25, 2013

agri-tourism on a farm means the following:

- (a) an agricultural heritage exhibit displayed on the farm;
- (b) a tour of the farm, an educational activity or demonstration in respect of all or part of the farming operations that take place on the farm, and activities ancillary to any of these;
- (c) cart, sleigh and tractor rides on the land comprising the farm;
- (d) activities that promote or market livestock from the farm, whether or not the activity also involves livestock from other farms, including shows, cattle driving and petting zoos;
- (e) dog trials held at the farm;
- (f) harvest festivals and other seasonal events held at the farm for the purpose of promoting or marketing farm products produced on the farm;
- (g) corn mazes prepared using corn planted on the farm.¹

alpine recreation² means snow skiing, snow boarding, snowmobiling, hiking, climbing or mountain biking;

amusement arcade means an establishment that contains four or more electronic or mechanical games for the entertainment of the public;

animal care means a building or structure used for veterinary clinic, animal hospital, or facilities for boarding or breeding household animals or pets;

applicant means a person applying for the approval of a subdivision, Board of Variance appeal, rezoning, a permit or a development, whether as the owner of the land or as the authorized agent of the owner;

aquaculture means the cultivation, rearing and harvesting of aquatic organisms on land or in the water, but specifically excludes seafood processing except on land located in the Agricultural Land Reserve;³

archaeological site means land containing material remains of archaeological value;

asphalt batch plant means the location on a parcel of a drum mixer asphalt plant;⁴

automotive repair means an establishment which provides mechanical repairs and routine maintenance services to vehicles and vehicle parts within a building;⁵

bay window means a projection from the wall of a building that contains a window or a series of windows, is cantilevered and may result in the projection of the adjacent floor structure;⁶

bed and breakfast means the economic activity of providing bedrooms within a dwelling unit and the first meal of the day for the temporary accommodation of the traveling public;

¹ Bylaw No. 500.413, adopted May 22, 2018

² Bylaw No. 500.253, adopted January 11, 2000

³ Bylaw No. 500.402, adopted June 28, 2016

⁴ Bylaw No. 500.166, deleting 'Portable', adopted April 11, 1995

⁵ Bylaw No. 500.408, adopted August 22, 2017

⁶ Bylaw No. 500.411, adopted September 12, 2017

provided that the occupancy by a member of the traveling public does not exceed 120 days in any calendar year;¹

boat building and repair means the use of land, buildings, structures or equipment for the manufacturing, servicing or repair of boats;

boat ramp means a structure located on a shoreline to accommodate vehicles or trailers for the purpose of launching and hauling boats out of water;

building means any structure and portion thereof, including mechanical devices, that are used or intended to be used for the purpose of supporting or sheltering any use or occupancy;

campground means a parcel providing for the seasonal and temporary accommodation of travelers using tents or recreational vehicles, but specifically excludes a mobile home park or hotel;

camping space² means an area within a campground, recreational vehicle park or resort vehicle park used for one recreational vehicle or tent;

cannabis means any plant of the genus *Cannabis*; including:

- a) any part of a cannabis plant, including the phytocannabinoids produced by, or found in, such a plant, regardless of whether that part has been processed or not;
- b) any substance or mixture of substances that contains or has on it any part of such a plant; and
- c) any substance that is identical to any phytocannabinoid produced by, or found in, such a plant, regardless of how the substance was obtained;³

cannabis production means the medical and non-medical commercial production, cultivation, synthesis, harvesting, altering, propagating, processing, packaging, storage, distribution or scientific research of cannabis or cannabis products as permitted by the *Access to Cannabis for Medical Purposes Regulations (ACMPR)* and *Bill C-45 (the Cannabis Act)*, and any subsequent regulations or acts which may be enacted henceforth, but excludes the growing of cannabis by an individual for their personal use and consumption⁴;

cannabis products means plant material from cannabis and any products that include cannabis or cannabis derivatives, intended for human use or consumption;⁵

category A lot means a parcel:⁶

- (a) located within the Resource Management 7 Zone, Resource Management 9 Zone, Rural 8 Zone, or Rural 9 Zone;
- (b) not located within the Forest Land Reserve or Agricultural Land Reserve; and
- (c) created by registration of a subdivision under the **Land Title Act (British Columbia)** or the Bare Land Strata regulation under the **Strata Property Act (British Columbia)** in the Land Title Office on or before the adoption of "Regional District of Nanaimo Arrowsmith Benson-Cranberry Bright Official Community Plan Bylaw No. 1148, 1999" by the Board of the Regional District of Nanaimo;

¹ Bylaw No. 500.270, adopted November 13, 2001

² Bylaw No. 500.162, adopted April 8, 1997

³ Bylaw No. 500.415, adopted March 27, 2018

⁴ Bylaw No. 500.415, adopted March 27, 2018

⁵ Bylaw No. 500.415, adopted March 27, 2018

⁶ Bylaw No. 500.253, adopted January 11, 2000

- Chief Building Inspector** means the Chief Building Inspector of the Regional District of Nanaimo;
- church** means a building used for religious worship and includes a Mosque, Synagogue, Temple, Chapel or religious meeting room;
- community sewer system** means a system of sewers and sewerage works including sewage treatment facilities owned, operated and maintained by or on behalf of the Regional District, a municipality or an improvement district;¹
- community water system** means a system of waterworks owned, operated and maintained by or on behalf of the Regional District, a municipality or an improvement district or which is operated by a person required to hold a certificate of public convenience and necessity under the **Water Utility Act**;²
- confined livestock area** means an outdoor area where livestock, poultry, or farmed game are confined by fences, other structures or topography, and includes paddocks, corrals, exercise yards, and holding areas, but does not include a grazing area;³
- convenience store** means a retail sales outlet contained under one roof, having a floor area not exceeding 200 m², and providing for the sale of items regularly used by households, including food, beverages, books, magazines or household accessories;
- correctional facility** means federal or provincial correctional facilities including halfway house for parolees where residents are appointed or placed by a court or administrative body for criminal justice;⁴
- cul de sac** means a highway with only one point of intersection with another highway and which terminates in a vehicle turning area;
- deck** means an open, unroofed platform with or without railings or parapets and supported by columns, foundations, walls or ground;⁵
- development area** means land defined by numerical map reference situated within a comprehensive development zone which is subject to specific regulations of that zone;⁶
- double frontage parcel** means a parcel which is either bisected by a highway or which has opposite boundaries, both of which have frontage on a highway;
- duplex** means two self-contained dwelling units oriented side-by-side with separate ground level entrances and adjoined by a common wall;⁷
- dwelling unit** means one self-contained unit contained within common walls with a separate entrance intended for year-round occupancy and the principal use of such dwelling unit is residential with complete living facilities for one or more persons, including permanent provisions for living, sleeping, cooking and sanitation;⁸
- eaves** means the part of a roof that meets or overhangs the walls of a building or structure;⁹
- eligible subdivision**¹ means lands located within a subdivision of a category A lot;

¹ Bylaw No. 500.238, adopted February 10, 1998

² Bylaw No. 500.238, adopted February 10, 1998

³ Bylaw No. 500.402, adopted June 28, 2016

⁴ Bylaw No. 500.179, adopted January 9, 1996

⁵ Bylaw No. 500.411, adopted September 12, 2017

⁶ Bylaw No. 500.95, adopted February 12, 1991

⁷ Bylaw No. 500.293, adopted August 12, 2003

⁸ Bylaw No. 500.113, adopted August 12, 1991

⁹ Bylaw No. 500.411, adopted September 12, 2017

emergency services² means the non-commercial use of land, buildings and structures for fire, police and ambulance services and may include temporary living accommodations for emergency service personnel.

explosives manufacturing means the use of land, buildings and structures for the manufacturing and storage of a product, substance, material or compound used for blasting purposes;

extraction use means the extraction of soil;

fairground means the use of land, buildings and structures for entertainment and recreational activity generally undertaken in an outdoor setting, where the users constitute a significant element in the activity, and includes go-cart track, waterslide, mini-golf course, amusement park;

farm means an occupation or use, for farm purposes, of one or several parcels of land or tenured areas of Crown land;³

farm operation means farm operation as defined in the *Farm Practices Protection (Right to Farm) Act* and may include but is not limited to activities such as growing, producing, raising or keeping animals or plants, including mushrooms, or the primary products of those plants or animals; aquaculture; and processing or direct farm marketing of products in accordance with the *Agricultural Land Reserve Use, Subdivision and Procedure Regulation*;⁴

farm retail sales means the sale to the public of products grown or raised on a farm, from that farm and may include the sale of non-farm products in accordance with the *Agricultural Land Reserve Use, Subdivision, and Procedure Regulation*.⁵

farm use means an occupation or use of land for farm purposes, including farming of land, plants and animals and any other similar activity designated as farm use by and in accordance with the *Agricultural Land Reserve Use, Subdivision and Procedure Regulation*, and includes but is not limited to activities such as farm retail sales; storing, packing, preparing and processing farm products; a winery or cidery; and agri-tourism activities and includes farm operation;⁶

fast food outlet means an eating establishment providing for the sale of prepared food and beverages that can be consumed in vehicles, taken off the premises for consumption or consumed on the premises;

feeder swine⁷ means a pig, between the age of 8 weeks and 6 months, weighing less than 102 kilograms;

feed lot⁸ means a fenced area where livestock, poultry, or farmed game are confined solely for the purpose of growing or finishing, and are sustained by means other than grazing;⁹

final approval means the Approving Officer affixing his signature to a subdivision plan pursuant to the **Land Title Act** and amendments thereto;

¹ Bylaw No. 500.253, adopted January 11, 2000

² Bylaw No. 500.386, adopted November 26, 2013

³ Bylaw No. 500.402, adopted June 28, 2016

⁴ Bylaw No. 500.402, adopted June 28, 2016

⁵ Bylaw No. 500.383, adopted June 25, 2013

⁶ Bylaw No. 500.402, adopted June 28, 2016

⁷ Bylaw No. 500.218, adopted August 12, 1997

⁸ Bylaw No. 500.218, adopted August 12, 1997

⁹ Bylaw No. 500.402, adopted June 28, 2016

floor area¹ means the sum total of the gross horizontal area of each floor of a building as measured from the inside surface of the outermost exterior walls.

floor area ratio means the figure obtained when the floor area of all buildings on a parcel, except those areas of a building providing covered parking area, is divided by the area of the parcel;²

frontage means that length of a parcel boundary which abuts a highway;

funeral parlour means an establishment with facilities for the preparation of the dead for burial or cremation, for viewing of bodies, and for funerals;

fur farm³ means the use of land, buildings or structures for the purposes of keeping fur-bearing animals and specifically excludes household animals, pets and rabbits;

gas bar means a premise containing not more than two gasoline pumping stations and which is used solely for the sale of fuel, lubricating oil and minor motor vehicle accessories directly to the users of motor vehicles;

gasoline service station means the use of land and structures for gasoline pumping stations and premises under one roof for:

- a) a sales outlet, having a gross floor area not exceeding 100 m², providing for the retail sales of items regularly used by households including food, beverages, books, magazines, and household accessories;
- b) the retail sales of motor vehicle accessories;
- c) the servicing and cleaning of motor vehicles;
- d) but specifically excludes vehicle sales, body work, painting and third party repairs;

gathering for an event means a gathering on a farm for the purpose of attending:

- (a) a wedding, unless paragraph (c) (ii) applies;
- (b) a music festival; or
- (c) an event, other than:
 - (i) an event held for the purpose of agri-tourism; or
 - (ii) the celebration, by residents of the farm and those persons whom they invite, of a family event for which no fee or other charge is payable in connection with the event by invitees.⁴

grazing area means a pasture or rangeland where livestock, poultry or farmed game are primarily sustained by direct consumption of feed growing in the area and does not include a confined livestock area or feedlot;⁵

gross leasable area (g.l.a.) means the floor area of a building that is designed to be rented or leased;

guest accommodation means temporary accommodation provided within a building or part of a dwelling unit and does not provide any provisions for cooking, sanitation or permanent

¹ Bylaw No. 500.396, adopted February 24, 2015

² Bylaw No. 500.95, adopted February 12, 1991

³ Bylaw No. 500.218, adopted August 12, 1997

⁴ Bylaw No. 500.413, adopted May 22, 2018

⁵ Bylaw No. 500.402, adopted June 28, 2016

residential occupancy¹ except for a maximum of 5 guest accommodation units to be used to accommodate seasonal employees and is not subdividable pursuant to the **Strata Property Act**.²

heavy equipment display means the use of land, buildings or structures for the display, sale or rental of mobile homes, industrial vehicles and machinery, and includes outdoor sales, and includes accessory servicing of such equipment;³

heavy industry means the use of land, buildings or structures for the storage, collection, processing, repairing, salvage or recycling of a product, article, substance, material, fabric or compound and includes a vehicle wrecking yard and seafood processing, but specifically excludes a waste disposal site;⁴

height⁵ means the elevation of a point directly below:

- a) that part of the building or structure being measured above land (or the surface of water at high water), and;
 - i. on a line connecting the two intersections of the natural grade and the outermost exterior building walls or supports as indicated on a plan showing any complete vertical section of that part of the building or structure being measured; or
 - ii. where a building is required to meet the minimum Flood Construction Level, that part of the building being measured above the Flood Construction Level as prescribed in the “Regional District of Nanaimo Floodplain Management Bylaw No. 1469, 2006”,⁶

highway includes a street, road, lane, bridge, viaduct and any other way open to the use of the public, but specifically excludes private rights of way on private property;

historic site means land, buildings or structures of historic or heritage significance;

home based business means an economic activity conducted as an accessory use on a parcel;⁷

home based business floor area means the sum total of gross horizontal area of each floor of those portions of a dwelling unit, attached garage or accessory building containing or used for a home based business, as permitted by this Bylaw;⁸

horse boarding stable⁹ means the use of land, buildings or structures for the purposes of keeping greater than 6 horses per hectare and specifically excludes accessory recreational uses;

hotel means a motel, resort or lodge, providing accommodation on a temporary basis and is not subdividable pursuant to the **Strata Property Act**;¹⁰

hotel unit means one self contained unit comprising a single tenancy with a separate entrance from a public space, corridor, common property or internally through the unit, intended for

¹ Bylaw No. 500.139, adopted February 9, 1993

² Bylaw No. 500.242, adopted June 13, 2000

³ Bylaw No. 500.13, adopted October 13, 1987

⁴ Bylaw No. 500.113, adopted August 13, 1991

⁵ Bylaw No. 500.396, adopted February 24, 2015

⁶ Bylaw No. 500.410, adopted September 12, 2017

⁷ Bylaw No. 500.270, adopted November 13, 2001

⁸ Bylaw No. 500.270, adopted November 13, 2001

⁹ Bylaw No. 500.218, adopted August 12, 1997

¹⁰ Bylaw No. 500.74, adopted October 8, 1991

temporary accommodation and may contain a maximum of one area intended for use for food preparation, but specifically excludes the use of a mobile home as a hotel unit;^{1,2}

household animal means a domesticated animal kept by a household, which is used or the product of which is used primarily and directly by the household and not for sale or profit, and includes fowl and poultry, but specifically excludes livestock;

household livestock means livestock animals kept by a household, which are used or the products of which are used primarily and directly by the household and not for sale or profit;³

household poultry means domesticated hens or ducks kept by a household, which are used or the products of which are used primarily and directly by the household and not for sale or profit;⁴

hutch means a projection from the wall of a building that does not contain a window, is cantilevered and results in the projection of the adjacent floor structure;⁵

inn⁶ means a building used exclusively for the temporary accommodation of the general public in hotel units wherein payment for occupancy is required to be made on a daily or weekly basis;

intensive swine operation⁷ means the use of land, buildings or structures for the purposes of keeping greater than 3 brood sows and 4 feeder swine per hectare;

internal access road means an internal access allowance within a campground, mobile home park or multiple dwelling unit development which is suitable for vehicular use;

include means as an example, but not limited to;

lake means a body of water other than the sea having a surface area of at least 2.0 ha for at least six months of the year;

land includes the surface of water;

landing means an open, unroofed platform or portion thereof with or without railings or parapets at the foot or head of a flight of stairs or between flights of stairs provided that it:

- a) is used for pedestrian access or egress to a building; and
- b) has a maximum area equal to the width of the stairs squared;⁸

lane means a highway not less than 6.0 m nor more than 7.5 m wide, which provides secondary access to any abutting parcel;

light industry means the wholesale, warehousing, testing, service, repair or maintenance of an article, substance, material, fabric or compound; and includes artisan and manufacturing shop, having a gross floor area not exceeding 200 m², and retail sales accessory to the principal use;

livestock means cattle, horses, sheep, goats, swine, and similar farmed or fur bearing animals;¹

¹ Bylaw No. 500.74, adopted October 8, 1991

² Bylaw No. 500.123, adopted December 10, 1991

³ Bylaw No. 500.402, adopted June 28, 2016

⁴ Bylaw No. 500.402, adopted June 28, 2016

⁵ Bylaw No. 500.411, adopted September 12, 2017

⁶ Bylaw No. 500.253, adopted January 11, 2000

⁷ Bylaw No. 500.218, adopted August 12, 1997

⁸ Bylaw No. 500.411, adopted September 12, 2017

loading space means a space for the loading or unloading of a vehicle either outside or inside a building or structure, but specifically excludes maneuvering aisles and other areas providing access to the space;

log storage and sorting yard means land used for the storage, dumping, sorting, booming and trans-shipment of logs;

lot means the same as parcel;

lot line means the legally defined line or lines bounding any parcel:

- a) **exterior side lot line** means a lot line or lines not being a front or rear lot line and common to the parcel and a highway, natural boundary, unregistered Crown Land;²
- b) **front lot line** means a lot line common to the parcel and an abutting highway or, where there is more than one such line, the shortest such line shall be considered as a front lot line, and any line which does not conform to any other definition of a lot line shall be deemed to be a front lot line; for a panhandle lot, the line separating the body of the lot from the panhandle shall be considered the front lot line;
- c) **interior side lot line** means a lot line not being a rear lot line and common to more than one parcel;
- d) **rear lot line** means the lot line opposite to and most distant from the front lot line and not abutting a highway, or where a rear portion of the parcel is bounded by intersecting side lot lines, it shall be the point of such intersection;³

major road means a highway designated a major road pursuant to an Official Community Plan adopted by the Regional District;

marina means moorage and launching facilities, including the rental and maintenance of boats and seaplanes, and which is equipped with public toilets and refuse disposal facilities located on land above the natural boundary;

marina sales means the use of land, buildings or structures for the sale and rental of boats and accessory marine equipment, but specifically excludes boat building and repair;

marine fuel supply station means a structure used primarily for the sale of fuel directly to boaters;

marshalling yard means the use of land, buildings and structures to store and maintain industrial equipment and vehicles;

Medical Health Officer means the Medical Health Officer or his delegate appointed pursuant to the **Health Act** and amendments thereto;

medium industry means the use of land, buildings or structures for assembling, processing, manufacturing or repairing of a product, article, substance, material, fabric or compound, but specifically excludes seafood processing and uses permitted in the Industrial 4 and Industrial 5 zones;

micro wind turbine system¹ means a wind energy conversion system consisting of a wind turbine, associated structures and mechanical devices with a nameplate rated capacity of not more than 1 kW.

¹ Bylaw No. 500.402, adopted June 28, 2016

² Bylaw No. 500.123, adopted December 10, 1991

³ Bylaw No. 500.17, adopted February 14, 1989

minimum parcel size means the smallest area into which a parcel may be subdivided;

minimum site area means the smallest contiguous portion of a parcel that is required by law for the development of one permitted use;

mobile home means a dwelling unit designed to be moved from time to time, which arrives at the site where it is to be occupied complete and ready for occupancy except for placing on foundation supports, connection of utilities, and some incidental assembly, and meets or exceeds Canadian Standards Association, Z-240 Standards or the requirements of the Chief Building Inspector, but specifically excludes recreational vehicles;

mobile home area means that part of a mobile home park used for siting mobile homes;

mobile home pad means an area within a mobile home space designated, designed and prepared for the support of a mobile home, surfaced with materials and provided with anchorage in accordance with the building regulations adopted pursuant to the **Local Government Act** and amendments thereto;

mobile home park means an unsubdivided parcel of land, not subdivided pursuant to the **Strata Property Act** and amendments thereto, on which are situated three or more mobile homes for the purposes of providing residential accommodation, but specifically excludes a hotel;²

mobile home space means an area of land within a mobile home area for installation of one mobile home;

motocross track³ means the use of land or structures for motorcycle motocross on a closed dirt track for recreational, training or competitive purposes but specifically excludes buildings and the use of any other type or form of motor vehicle, trailer, traction engine, farm tractor, road building machine and any vehicle drawn, propelled or driven by any kind of power including muscular power whether the vehicle is licensed or not under the **Motor Vehicle Act**;

Mount Arrowsmith employee⁴ means an individual either employed or self-employed and whose place of employment is situated within the boundaries of Mount Arrowsmith Regional Park;

Mount Arrowsmith staff⁵ means a Mount Arrowsmith employee or individuals cohabiting with a Mount Arrowsmith employee in common occupancy;

multiple dwelling unit development means the establishment of three or more dwelling units on a parcel;

mushroom farm⁶ means the use of buildings or structures for the purposes of growing, producing, storing, and processing of mushrooms;

natural boundary means the visible high water mark on any watercourse where the presence and action of the water are so common and usual, and so long continued in all ordinary years, as to mark upon the soil of the bed of the watercourse a character distinct from that of the banks thereof, in respect to vegetation as well as in respect to the nature of the soil itself;

¹ Bylaw No. 500.396, adopted February 24, 2015

² Bylaw No. 500.123, adopted December 10, 1991

³ Bylaw No. 500.253, adopted January 11, 2000

⁴ Bylaw No. 500.253, adopted January 11, 2000

⁵ Bylaw No. 500.253, adopted January 11, 2000

⁶ Bylaw No. 500.218, adopted August 12, 1997

natural site means land of scenic or environmental significance;

neighbourhood pub means an establishment operating under a 'D' type license issued pursuant to the **Liquor Control and Licensing Act** and amendments thereto;

non-resident employee means an employee of a home based business who is not a permanent resident of the parcel on which the home based business is located;¹

nursery means the use of land principally involved in agriculture or horticulture and accessory product sales and garden supply sales, but specifically excludes the sale of agricultural or horticultural machinery;

office means the occupancy or use of a building for the purpose of carrying out business or professional activities, but specifically excludes retail activities and personal service use;

outdoor recreation means a recreational activity undertaken where the outdoor setting and landscape is a significant element in the activity, and the density of recreational users is not a significant element and includes playing field, botanical garden, arboretum, outdoor exhibit, golf course, driving range and mini golf where the course structures do not exceed 1 m in height;²

outdoor sales means the use of land, buildings or structures for the retail sale of lumber and building products and the display, sale or rental of recreational vehicles, automobiles, mobile homes and boats, and includes accessory servicing of such equipment;³⁴

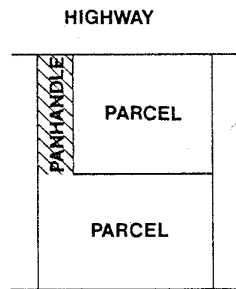

Panhandle (not to scale)

panhandle means a strip of land which provides access and highway frontage to a parcel, and which forms part of that parcel, as illustrated below:

parcel means the smallest area of land which is registered in the Land Title Office, except that a parcel divided pursuant to the Strata Property Act and amendments thereto and not contained within a Bare Land Strata Plan shall not be considered subdivided for the purpose of this Bylaw;

parcel area means the total horizontal area between the lot lines of a parcel;

parcel coverage means the sum total horizontal area as measured from the outermost perimeter of all buildings or part thereof on the parcel expressed as a percentage of the total parcel area;

¹ Bylaw No. 500.270, adopted November 13, 2001

² Bylaw No. 500.96, adopted January 8, 1991

³ Bylaw No. 500.79, adopted April 10, 1990

⁴ Bylaw No. 500.13, adopted October 13, 1987

parcel depth means the distance between the front lot line and the most distant part of the rear lot line of a parcel;

park means deeded public land used or intended for outdoor recreation purposes, and includes an archaeological, historical or natural site;

parking space means the space for the parking of one vehicle either outside or inside a building or structure, but excludes maneuvering aisles and other areas providing access to the space;

permitted use means the principal permissible purpose for which land, buildings or structures may be used, and for the purpose of this Bylaw all uses not listed as permitted shall be deemed to be a prohibited use in that zone;

personal care means a community care facility developed in accordance with the Community Care Facility Act and amendments thereto, or a hospital developed in accordance with the Hospital Act and amendments thereto;

personal care unit mean a dwelling unit designed in conjunction with special support facilities, such as food, housekeeping and medical services, and used by persons requiring such services on a regular basis and may include housing for the elderly and handicapped and other residential arrangements operated by a society or organization for charitable, religious, educational or social purposes, but does not include correctional facilities where residents are appointed or placed by a court or administrative body for criminal justice;¹

personal service use means a use whereby professional or personal services are provided and the sale of goods, wares, merchandise, articles or things accessory to the provision of such services, and includes barber shop, beauty salon, shoe repair shop, drycleaning shop and launderette;

pet means a tame animal, kept as a favourite by a household and not primarily for sale or profit, and commonly housed within a dwelling unit;

Planning Director means the Planning Director of the Regional District;

potable water means water which meets the drinking standards in accordance with regulations of the relevant enactments;

poultry means domesticated birds kept for eggs, meat, feathers, hide, or cosmetic or medicinal purposes, and includes broilers, Cornish hens, layers, breeding stock, replacement pullets, roasters, ducks, geese, turkeys, game birds, and ratites;²

preliminary layout approval means a written review by the Approving Officer indicating that a proposed plan of subdivision is acceptable subject to stated conditions which must be fulfilled prior to final approval;

primary processing means the use of land, buildings or structures for the moving, crushing, washing, screening, processing or storage of soil;

principal use means the main use of land, buildings or structures as listed under the permitted uses of the applicable zone;

produce market means a building or structure providing for the retail sale of agricultural produce including vegetables, fruit and seafood;

¹ Bylaw No. 500.179, adopted January 9, 1996

² Bylaw No. 500.402, adopted June 28, 2016

produce stand means a building or structure not exceeding 100 m² in area providing for the retail sale of fresh agricultural produce, which are produced on the same farm on which the stand is located;

production of biological integrated pest management products means the use of land, buildings, or structures for the production and development of biological products such as beneficial predatory insects, parasites, pathogens, and weed-feeders to be used in biological integrated pest management programs in accordance with the *Agricultural Land Reserve Use, Subdivision and Procedure Regulation*;¹

public assembly use means the use of land, buildings or structures to accommodate exhibits, special events or meetings and includes auditorium, church, museum, community hall, fraternal lodge, youth centre, theatre;

public utility use² means the use of land, buildings or structures for the provision of community water or sewer services, park, public access, pipelines, electric and telephone service, emergency services, government office or cemetery;

railway means a railway and accessory uses as defined by the **Railway Act**;³

recreation facility means a facility used and equipped for the conduct of sports and leisure activities and includes pool hall, bowling alley, games court, curling and roller rink, health club, spa, swimming pool, but specifically excludes amusement arcade and fairground;

recreational vehicle means any vehicle, trailer, coach, house-car, structure or conveyance designed to travel or be transported on a highway and constructed and equipped to be used as temporary living or sleeping quarters by travelers;

recreational vehicle park⁴ means a parcel providing for the seasonal and temporary accommodation of travelers for not more than six months of the calendar year using tents or recreational vehicles, not exceeding 37m² (400 ft²) in floor area, but specifically excludes a mobile home park or hotel;

Regional District means the Regional District of Nanaimo;

remainder means that portion of a parcel being subdivided which is shown on the same Certificate of Indefeasible Title before and after the subdivision;

residential use means the accommodation and homelife of a person or persons in common occupancy, and shall only be conducted within a dwelling unit;

resort condominium development means a hotel and includes hotel units subdivided pursuant to the **Strata Property Act** and amendments thereto;⁵

resort condominium unit means a hotel unit which is subdivided pursuant to the Strata Property Act and amendments thereto;⁶

resort vehicle park⁷ means a parcel providing for seasonal or periodic accommodation of travelers or residents using tents or recreational vehicles not exceeding 37 m² (400 ft²) in floor area, but specifically excludes a mobile home park or hotel;

¹ Bylaw No. 500.402, adopted June 28, 2016

² Bylaw No 500.386, adopted November 26, 2013

³ Bylaw No. 500.283, adopted August 13, 2002

⁴ Bylaw No. 500.162, adopted April 8, 1997

⁵ Bylaw No. 500.74, adopted October 8, 1995

⁶ Bylaw No. 500.74, adopted October 8, 1995

⁷ Bylaw No. 500.162, adopted April 8, 1997

restaurant means an eating establishment providing for the sale of prepared foods and beverages to be consumed on the premises, but specifically excludes neighbourhood pub and fast food outlet;

retaining wall means a structure erected to hold back or support a bank of earth;

retail store means a sales outlet contained under one roof, having a gross floor area not exceeding 2000 m², and providing for the retail sale and display of goods, but specifically excludes industrial uses and gasoline service station;

road means the same as highway;

school means privately funded, parochial and public schools;

seafood processing means the storage, drying, cooking, packing, preparation and manufacture of any aquatic organism;

secondary suite means one or more habitable rooms and a cooking facility for residential accommodation, consisting of a self-contained unit with a separate entrance but which is clearly accessory to a principal dwelling unit located on the same parcel as the secondary suite and may not be subdivided under the *Strata Property Act*.¹

separation distance means the minimum horizontal distance between a building or structure or part thereof to another building or structure or part thereof;²

setback means the required minimum horizontal distance measured from the respective lot line or natural boundary to any building or structure or part thereof;

shipping yard means the use of buildings, structures or land providing for the trans-shipment of goods;

shopping centre means a group of sales and service outlets, including retail store, personal service, amusement arcade, office, recreation facility, restaurant, contained within a single building or structure sharing a common roof, having a floor area not exceeding 20 000 m², and located on a single parcel;

silviculture means all activities related to the development and care of forests, including the removal of harvestable timber stocks, but specifically excludes the processing of wood or wood products;

ski lodge³ means a building within which are located administrative uses of a nature customarily incidental, subordinate and exclusively devoted to an alpine recreation use including office, ticket booth, child care facility, and changing area and lockers. In conjunction with one or more of the administrative uses, a ski lodge may also contain the following commercial uses: hotel unit; sale or rental of alpine recreation equipment; tourist store; restaurant; or establishment operating under a Class A, Recreational Centre License issued pursuant to the **Liquor Control and Licensing Act**;

slope means the figure obtained when the vertical distance of an area of land is divided by the horizontal distance, expressed as a percentage;

soil includes sand, gravel, rock or other substance of which land is composed;

¹ Bylaw No. 500.389, adopted May 27, 2014

² Bylaw No. 500.61, adopted March 27, 1990

³ Bylaw No. 500.253, adopted January 11, 2000

structure¹ means anything that is constructed or erected, and includes swimming pool, mobile home space, camping space and major improvements accessory to the principal use of land, but specifically excludes landscaping, paving improvements and signs under 1.0 m in height, retaining walls under 1.0 m in height that retain less than 1.0 m of earth, fences under 2.0 m in height and transparent fencing or transparent vertical extensions greater than 2.0 m in height where the fence is required for agriculture or farm use;²

swine³ means any pig, piglet, hog, sow, brood sow or boar being both over the age of 8 weeks and weighing greater than 18 kilograms;

temporary sawmill means a building or structure or area where timber is cut or sawed and at least 50% of the volume of timber supplied is from the farm or parcel on which the sawmill is located and operates during normal daylight hours producing less than 60 m³ of lumber daily;⁴

theatre means a building or structure designed to stage public performances;

tourist information booth means a building or structure that is used solely for the purpose of providing information to the traveling public;

tourist store means a retail sales outlet contained under one roof, having a gross floor area not exceeding 200 m², and providing for the retail sale of goods to the traveling public, and provision for personal service use and/or office use;⁵

transportation terminal means the use of land, buildings or structures for taxi, bus, railway stations, airport, and the storage and maintenance of transportation equipment;

unattended public utility use means a public utility use which generally does not require personnel on a regular basis for operation of the facility;

use means the same as permitted use;

vehicle means a vehicle licensed pursuant to the **Motor Vehicle Act**, and any vehicle or portion thereof which does not have a valid license plate on the vehicle and which is not stored in a building shall be deemed to be a derelict vehicle;

vehicle sales means the use of land or buildings for the sale of vehicles;⁶

vehicle wrecking yard means the use of land or a structure not totally enclosed by walls or a roof for the dismantling or wrecking of vehicles, or for the storage of derelict vehicles;⁷

waste disposal site means the use of land or buildings for the treatment and disposal of solid wastes, operated by the Regional District or a Municipality;

watercourse means any natural or man-made depression with well defined banks and a bed of 0.6 m or more below the surrounding land serving to give direction to or containing a current of water at least six months of the year and includes the sea or any lake, river, stream, creek, spring, ravine, swamp, gulch, surface source of water supply or source of groundwater supply whether enclosed or in a conduit;

¹ Bylaw No. 500.123, adopted December 10, 1991

² Bylaw No. 500.402, adopted June 28, 2016

³ Bylaw No. 500.218, adopted August 12, 1997

⁴ Bylaw No. 500.402, adopted June 28, 2016

⁵ Bylaw No. 500.150, adopted November 9, 1993

⁶ Bylaw No. 500.408, adopted August 22, 2017

⁷ Bylaw No. 500.113, adopted August 13, 1991

wood processing means a building, structure or equipment operating during normal daylight hours, processing less than 60 m³ of logs per day including the preparation of logs, fence posts, shakes, poles or firewood;¹

wood waste disposal facility² means the use of lands, buildings, and structures for the processing of sawmill, construction, land clearing wood waste materials under agreement with the Regional District of Nanaimo.

¹ Bylaw No. 500.253, adopted January 11, 2000

² Bylaw No. 500.253, adopted January 11, 2000

REGIONAL DISTRICT OF NANAIMO

BYLAW NO. 500

PART 3

LAND USE REGULATIONS

PART 3 LAND USE REGULATIONS

3.1 Zones

- 1) For the purpose of this Bylaw, the area described in the section of this Bylaw entitled **Application** is hereby divided into zones designated and described by the following classifications and their short title equivalents:

ZONE CLASSIFICATION	SHORT TITLE
Agriculture 1	AG1
Agriculture 2	AG2
Commercial 1 Zone	CM1
Commercial 2 Zone	CM2
Commercial 2.1 Zone	CM2.1
Commercial 3 Zone	CM3
Commercial 4 Zone	CM4
Commercial 5 Zone	CM5
Commercial 6 Zone	CM6
Commercial 7 Zone	CM7
Commercial 8 Zone	CM8
Conservation 1 Zone	ES1
Industrial 1 Zone	IN1
Industrial 2 Zone	IN2
Industrial 3 Zone	IN3
Industrial 4 Zone	IN4
Industrial 5 Zone	IN5
Public 1 Zone	PU1
Public 2 Zone	PU2
Public 3 Zone	PU3
Public 4 Zone	PU4
Public 6 Zone	PU6
Recreation 1 Zone	RC1
Recreation 2 Zone	RC2
Recreation 3 Zone	RC3
Recreation 4 Zone	RC4
Recreation 5 Zone	RC5
Recreation 6 Zone	RC6
Residential 1 Zone	RS1
Residential 1.1 Zone	RS1.1
Residential 1.2 Zone	RS1.2
Residential 2 Zone	RS2
Residential 2.1 Zone	RS2.1
Residential 2.2 Zone	RS2.2

ZONE CLASSIFICATION continued

**SHORT
TITLE**

Residential 3 Zone	RS3
Residential 4 Zone	RS4
Residential 5 Zone	RS5
Residential 6 Zone	RS6
Residential 7 Zone	RS7
Residential 8 Zone	RS8
Resort Commercial	RCM
Resource Management 1 Zone	RM1
Resource Management 2 Zone	RM2
Resource Management 3 Zone	RM3
Resource Management 4 Zone	RM4
Resource Management 5 Zone	RM5
Resource Management 6 Zone	RM6
Resource Management 7 Zone	RM7
Resource Management 8 Zone	RM8
Resource Management 9 Zone	RM9
Rural 1 Zone	RU1
Rural 1.1 Zone	RU1.1
Rural 2 Zone	RU2
Rural 3 Zone	RU3
Rural 4 Zone	RU4
Rural 5 Zone	RU5
Rural 6 Zone	RU6
Rural 7 Zone	RU7
Rural 8 Zone	RU8
Rural 9 Zone	RU9
Rural 10 zone	RU10
Water 1 Zone	WA1
Water 2 Zone	WA2
Water 3 Zone	WA3
Water 4 Zone	WA4
Schooner House Comprehensive Development Zone 4	CD4
Wembley Comprehensive Development Zone 5	CD5
Bowser Village Comprehensive Development Zone 6	CD6
Fairwinds Comprehensive Development Zone 8	CD8
Horne Lake Comprehensive Development Zone 9	CD9
South Wellington Comprehensive Development Zone 10	CD10
South Wellington 2 Comprehensive Development Zone 11	CD11
Rondalyn Resort Comprehensive Development Zone 13	CD13
Englishman River Comprehensive Development Zone 14 (BLOCK 564)	CD14

ZONE CLASSIFICATION continued	SHORT TITLE
Kipp Road Industrial Comprehensive Development Zone 15	CD15
Comprehensive Development Zone 17 (NCID)	CD17
Schoolhouse Road Light Industrial Comprehensive Development Zone 18	CD18
Midora Road Comprehensive Development Zone 19	CD19
Parklands Mobile Home Park Comprehensive Development Zone 20	CD20
Comprehensive Development Zone 21 (Doumont)	CD21
Horne Lake Regional Park Comprehensive Development Zone 24	CD24
Claudet Road Rural Comprehensive Development Zone 26	CD26
South Wellington Light Industrial Comprehensive Development Zone 28	CD28
Cedar Estates Comprehensive Development Zone 29	CD29
Nanoose Bay Village Centre Comprehensive Development Zone 30	CD30
Horne Lake Road Comprehensive Development Zone 32	CD32
Schoolhouse and Harold Roads Light Industrial Comprehensive Development Zone 33	CD33
Ridge Town Homes Comprehensive Development Zone 34	CD34
Rockcliffe Comprehensive Development Zone 35	CD35
1680 Timberlands Comprehensive Development Zone 36	CD36
Main Road Light Industrial Comprehensive Development Zone 37	CD37
Qualicum Bay Seniors Development Comprehensive Development Zone 41	CD41
Crown and Anchor Campground Comprehensive Development Zone 42	CD42
Schooner Bay Manor Seniors Mobile Home Park Comprehensive Development Zone 43	CD43
Lakes District Comprehensive Development Zone (CD44)	CD44
Schooner Cove Comprehensive Development Zone (CD45)	CD45
Fielding Road Light Industrial Comprehensive Development Zone 49	CD49
Beck Road Comprehensive Development Zone 50	CD50
Comprehensive Development Zone 51	CD51 ¹
Lighthouse Villa Comprehensive Development Zone 52	CD52 ²

- 2) The extent of each zone is shown on Schedule '3A'.

¹ Bylaw No. 500.404, adopted October 16, 2018

² Bylaw No. 500.418, adopted December 4, 2018

- 3) Where a zone boundary is designated as following a highway or a watercourse, the centerline of the highway or the natural boundary of the watercourse or the centerline of a creek shall be the zone boundary.
- 4) Where a zone boundary does not follow a legally defined line, and where distances are not specifically indicated, the location of the boundary shall be determined by scaling from Schedule '3A'.
- 5) Where a parcel is divided by a zone boundary, the areas created by such division shall be deemed to be separate parcels for the purpose of determining parcel coverage, setbacks, minimum site area and floor area ratio of this Bylaw³.
- 6) Where a parcel exists prior to the effective date of this Bylaw and the site area of the parcel does not conform to the provisions of this Bylaw, such parcel having an area less than the specified site area in the applicable zone may:
 - a) be used for only one permitted use in the applicable zone, provided that the requirements of the authority having jurisdiction are met with respect to provision of water and method of sewage disposal and the use may not be extended; or
 - b) be developed in accordance with the provisions and regulations of the Residential 1 zone.
- 7) Site area requirements do not apply to an unattended public utility use and park; and such uses are permitted in each zone.

3.2 General Operative Clauses

1) Permitted Uses

No land, building or structure in any zone shall be used for any purpose other than that specified for the zone in which it is located in the schedules contained in this Part.

2) Siting, Size and Shape

No building or structure shall be constructed, moved or altered so that its:

- a) site area is less;
- b) siting provides less setback requirements;
- c) parcel coverage is greater;
- d) height is greater;
- e) floor area ratio is greater; or
- f) total number of units, buildings or structures is greater than specified for the zone in which it is located in the schedules contained in this Part.

3) Parcel Area, Shape and Dimensions⁴

- a) Land shall not be subdivided to create parcels having a minimum parcel area less than that prescribed by Schedule '4B' of this Bylaw, nor with shape or dimensions contrary to those prescribed by Section 4.4 of this Bylaw.
- b) For the purpose of this Bylaw in determining how parcel areas are expressed on plans registered after February 22, 2011, the size of a parcel shall be determined by reference to parcel size established by a B.C. Land Surveyor based on the following table:

³ Bylaw No. 500.123, adopted December 10, 1991

⁴ Bylaw No. 500.500.360, adopted January 25, 2011

Expression of Parcel Areas

Parcel Size	Maximum Number of Decimal Places Accepted
up to 0.1 ha	quote to 0.1m ²
from 0.1 ha up to 1 ha	quote to 0.001 ha
from 1 ha up to 10 ha	quote to 0.01 ha
from 10 ha up to 100 ha	quote to 0.1 ha
from 100 ha and over	quote to 1 ha

4) **Off-Street Parking and Loading Spaces**

Off-street parking and loading spaces shall be provided in accordance with the regulations of this Part.

5) **Setbacks**

Setbacks shall be provided in conformity with this Part.

3.3 General Regulations

1) **Accessory Buildings and Structures**

Buildings and structures accessory to the permitted use of a parcel are permitted in each zone, unless otherwise specified, provided that:

- a) the principal use is being performed on the parcel; or
- b) a building for the purpose of the principal use has been constructed on the parcel; or
- c) a building for the purpose of the principal use is in the process of being constructed on the parcel.

2) **Common Accessory Uses**

Accessory buildings and structures in a multiple dwelling unit development, resort condominium development or development pursuant to the **Strata Property Act**, shall be limited to accessory buildings and structures indicated as common property on the strata plan and generally intended for the common use of property owners or occupiers in the development, and may include facilities for storage, parking, laundry, service and recreation.⁵

3) **Storage of Fuel**

No parcel shall be used for the storage, warehousing, distribution or wholesale of any type of fuel or flammable or combustible liquids in either above ground or below ground tanks in excess of 4546 litres (1,000 imperial gallons); and further that this regulation does not apply to industrial zones, gasoline service stations, marine fuel supply stations, asphalt batch plants or to fuel used for residential heating purposes.⁶

⁵ Bylaw No. 500.74, adopted October 8, 1991

⁶ Bylaw No. 500.123, adopted December 10, 1991

4) **Vehicle Wrecking Yard or Refuse**

Unless specifically permitted, no parcel shall be used as a vehicle wrecking yard or for the collection or storage of refuse.⁷

5) **Keeping of Animals⁸⁹**

a) In all zones where agriculture or farm use is not a permitted use, the keeping of animals shall be deemed to be an accessory use and shall be limited to:

- i) on parcels less than 1000 m² in size the keeping of animals is restricted to pets and household poultry in accordance with Subsection 5b;
- ii) on parcels 1000 m² or greater in size, the keeping of animals is restricted to household animals and pets;
- iii) on parcels 1.0 ha or greater in size, the keeping of pets, household animals, and household livestock is permitted.

b) The keeping of household poultry on parcels less than 1000 m² is subject to the following regulations:

- i) must be accessory to the residential use of the parcel;
- ii) a maximum of 5 hens or ducks are permitted per parcel;
- iii) no roosters, cockerels, or peacocks, and the like may be kept on the parcel;
- iv) a minimum enclosure of 0.37 m² (4 ft²) per hen or duck must be provided;
- v) any building or structure containing household poultry, whether portable or stationary, must:
 - a. meet the minimum setback requirements of the applicable zone and in no case shall be sited within 2.0 m of any lot line;
 - b. not be located within the front yard or exterior side yard;
 - c. have a maximum floor area of 10 m² and a maximum height of 3.0 m.”

6) **Landscaping**

Landscaping shall be provided in accordance with the regulations of this Part.

7) **Setbacks - Sight Triangle**

On a corner parcel in any zone there shall be no obstruction to the line of vision above the height of 0.5 m of the established grade of a highway within the sight triangle, being a triangular area formed by extending a 6.0 m boundary along the parcel lines from the point of the exterior corner intersection of the parcel lines and a line connecting these two points as illustrated below:

⁷ Bylaw No. 500.113, adopted August 13, 1991

⁸ Bylaw No. 500.74, adopted October 8, 1991

⁹ Bylaw No. 500.402, adopted June 28, 2016

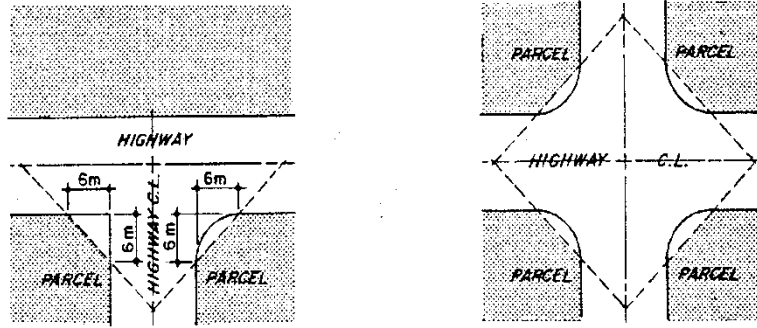

Sight Triangle (not to scale)

8) Setbacks - Watercourses, excluding the Sea

- a) On parcels with an average slope of 5% or less adjacent to or containing a watercourse, no building or structure shall be constructed, altered, moved or extended within the following setbacks:
 - i) within 15.0 m horizontal distance from the natural boundary or within 18.0 m horizontal distance from a stream centerline, whichever is greater as illustrated in Table 1 and Table 2 of Schedule '3E';
 - ii) within 30.0 m horizontal distance from the natural boundary of the Nanaimo River, the Englishman River, the Little Qualicum River and the Qualicum River.
- b) On parcels with an average slope of greater than 5% adjacent to or containing a watercourse, no building or structure shall be constructed, altered, moved or extended within the following setbacks:
 - i) within 9.0 m horizontal distance from the top of the slope or the first significant and regular break in the slope as illustrated in Table 3 of Schedule '3E';
 - ii) within 30.0 m horizontal distance from the natural boundary of the Nanaimo River, the Englishman River, the Little Qualicum River and the Qualicum River.

9) Setbacks - Sea¹⁰

- a) For all Electoral Areas, except Electoral Area 'E', on parcels adjacent to or containing a coastal watercourse, no building or structure shall be constructed, moved, extended
 - i) within 8.0 metres horizontal distance inland from the top of a slope of 30% or greater; or
 - ii) within 8.0 metres horizontal distance from the natural boundary, whichever is greater.
- b) For Electoral Area 'E', on parcels adjacent to or containing a coastal watercourse, no building or structure shall be constructed, moved, extended
 - iii) within 8.0 metres horizontal distance inland from the top of a slope of 30% or greater; or

¹⁰ Bylaw No. 500.324, adopted February 28, 2006

- iii) within 8.0 metres horizontal distance inland from the top of a slope of 30% or greater; or
- iv) within 15.0 metres horizontal distance from the natural boundary, whichever is greater.

10) **Setbacks – Buildings and Structures¹¹**

a) **Agriculture and Farm Buildings, Structures and Uses¹²**

The following minimum setback requirements shall apply to all agriculture or farm buildings, structures and uses.

Use(s)	Setback from all lot lines
1) The following shall apply to all agriculture or farm buildings, structures, and uses	
I. Outdoor uncovered horse riding rings and exercise yards where no feeding of animals occurs	0 m
II. Buildings and structures 10 m ² or less that house any livestock or poultry (except household poultry on parcels less than 1000 m ² in area), game, or other furbearing farm animals	8.0 m
III. Indoor horse riding rings where no feeding or housing of animals occurs	8.0 m
IV. Buildings and structures 50 m ² or less that house any livestock, poultry, game, or other furbearing farm animals	15.0 m
V. Confined Livestock Area	
VI. Buildings and structures more than 50 m ² that house any livestock, poultry, game, or other furbearing farm animals	30.0 m
VII. Feedlot	
VIII. Indoor riding rings where feeding or housing of animals occurs	
IX. Mushroom Barn	
X. Temporary Sawmill	
XI. Buildings, structures, and lands used for: <ul style="list-style-type: none"> a. the storage of agricultural liquid or solid waste b. On-farm composting 	

¹¹ Bylaw No. 500.396, adopted February 24, 2015

¹² Bylaw No. 500.402, adopted June 28, 2016

c. Compost storage		
XII.	Cannabis Production - All building and structures except: a. the setback shall be 60.0 m from all lot lines adjacent to non-ALR residential uses and; b. the setback shall be 150.0 m from any parcel that contains a park or school ¹³	30.0 m
XIII.	Gathering for an Event – All building, structures or event areas	30.0 m ¹⁴
XIV.	All other agricultural buildings and structures	8.0 m ¹⁵
2) The following watercourse setbacks shall apply to all agriculture or farm buildings, structures and uses:		
I. All buildings and structures that house any livestock or poultry (except household poultry) or store manure and all areas used for a feedlot shall be a minimum of 30 m from a domestic well, spring, or the natural boundary of a watercourse.		
II. All other agriculture or farm buildings and structures shall be sited in accordance with Sections 3.3.8 and 3.3.9 "		

b) Micro wind turbine systems

- i) For a system installed on the ground, the minimum setback from all parcel boundaries shall be equal to the height of the system as measured from the natural grade at the base of the wind turbine tower to the top of the highest vertical extension of the wind turbine at the top of the rotor blade arc; or
- ii) For a system installed on a rooftop or side of a building, the minimum setback from all parcel boundaries shall be equal to the height of the system as measured from the lowest point of the micro wind turbine system to the top of the highest vertical extension of the wind turbine at the top of the rotor blade arc.
- iii) No such system shall be located within 60 metres of any eagle or heron nesting tree, as determined by a Qualified Environmental Professional (QEP), measured from the base of the nesting tree to the base of the wind turbine system.

c) Highway No. 19¹⁶ ¹⁷

¹³ Bylaw No. 500.415, adopted March 27, 2018

¹⁴ Bylaw No. 500.413, adopted May 22, 2018

¹⁵ Bylaw No. 500.413, adopted May 22, 2018

¹⁶ Bylaw No. 500.360, adopted January 25, 2011

¹⁷ Bylaw No. 500.402, adopted June 28, 2016

For Electoral Area 'G' only, the minimum required setback for all buildings and structures adjacent to the Vancouver Island Highway No. 19 shall be the minimum setbacks prescribed in each zone or 15.0 metres, whichever is greater.

- d) Projections into Required Setbacks¹⁸
 - i) In RS1, RS1.1, RS1.2, RS2, RS2.1, RS2.2, RS3, RS4, and RS5 zones, decks, stairs, landings and wheel chair ramps less than 0.6 metres above finished grade immediately adjacent to a building may be located up to 0.6 metres from an interior side lot line and 1.5 metres from a rear lot line.
 - ii) The following table outlines features which may project into the front, rear, interior side or exterior side lot line setback as specified:

¹⁸ Bylaw 500.411, adopted September 12, 2017

Feature	Zone	Permitted Projection into Required Setbacks			
		Front	Rear	Interior Side	Exterior Side
Hutches, canopies, chimneys, cornices, eaves, gutters, leaders, ornamental features, pilasters, sills, sunshades	RS1	1.75 m	0.6 m	0.6 m	1.75 m
	RS1.1	Not permitted		0.6 m	
	RS1.2	Not permitted		Not permitted	
	RS2	1.75 m		0.6 m	
	RS2.1	1.75 m		0.6 m	
	RS2.2	1.75 m		Not permitted	
	RS3	1.75 m		0.6 m	
	RS4	1.75 m		0.6 m	
	RS5	1.75 m		0.6 m	
Footings below finished grade	RS1	0.5 m	0.5 m	0.5 m	0.5 m
	RS1.1				
	RS1.2				
	RS2				
	RS2.1				
	RS2.2				
	RS3				
	RS4				
	RS5				
Bay window	RS1	1.75 m	Not permitted	Not permitted	Not permitted
	RS1.1	Not permitted			
	RS1.2	Not permitted			
	RS2	1.75 m			
	RS2.1	1.75 m			
	RS2.2	1.75 m			
	RS3	1.75 m			
	RS4	1.75 m			
	RS5	1.75 m			

- iii) For certainty, a projection into a required setback must not obstruct the sight triangle as specified in Section 3.3.7.
- iv) For certainty, where a lot line is referenced as other and meets the definition of front, rear, interior side or exterior side lot line, the corresponding permitted projection of this section applies.

11) **Stormwater Management for Farm Use**¹⁹

Where the total impervious area of agriculture or farm buildings and structures exceeds 3,700 square metres or covers more than 25% of a parcel or contiguous parcels a stormwater management plan is required.

¹⁹ Bylaw No. 500.402, adopted June 28, 2016

12) **Height Exemptions**²⁰

The following structures, mechanical devices or parts of buildings may exceed a height restriction under this Bylaw:

- a) Chimney stacks, mast aerials, church spires, flag poles, water tanks, observation and transmission towers, and mechanical devices necessary for the operation of a building.²¹
- b) Principal agricultural or farm buildings or structures.²²
- c) Components of solar photovoltaic or solar thermal systems where:
 - i) On a parcel less than 5,000 m² in area
 - a. the over-height portion of such system is limited to 50% of the roof width to which the system is attached;
 - b. no portion of such system exceeds 0.6 metre above the maximum permitted height; and
 - c. the system must be affixed to a roof with a pitch not exceeding 3:12.
 - ii) On a parcel 5,000 m² or greater in area, no portion of such system exceeds 0.6 metre above the maximum permitted height.
- d) One over-height micro wind turbine system per parcel provided that no such system exceeds twice the maximum permitted height, as measured from the natural grade at the base of the wind turbine tower to the top of the highest vertical extension of the wind turbine at the top of the rotor blade arc.

13) **Density - Category A Lots**²³

For clarity, where a category A lot is divided between more than one zone, two dwelling units are permitted on only one parcel located within the eligible subdivision.

14) **Home Based Business**²⁴

On parcels where a home based business is a permitted use, the following provisions apply:

- a) The following activities shall be permitted as a home based business:
 - i) processing of goods;
 - ii) sales of related or unrelated goods combined with home based business product sales to a maximum of 1/3rd of home based business floor area;
 - iii) bed and breakfast provided the activity is contained wholly within the dwelling unit to a maximum of 2 bedrooms in Residential 1 and 3 zones and to a maximum of 4 bedrooms in all other zones where permitted by this Bylaw;

²⁰ Bylaw No. 500.396, adopted February 24, 2015

²¹ Bylaw No. 500.402, adopted June 28, 2016

²² Bylaw No. 500.402, adopted June 28, 2016

²³ Bylaw No. 500.253, adopted January 11, 2000

²⁴ Bylaw No. 500.270, adopted November 13, 2001

- iv) rental of non-motorized outdoor recreation equipment;
 - v) personal service use;
 - vi) professional practice; and
 - vii) office.
- b) Despite Section 3.3.14 a), the following activities are prohibited as a home based business:
- i) animal breeding in excess of two litters per calendar year;
 - ii) dog boarding;
 - iii) public assembly use;
 - iv) school pursuant to the **Schools Act**;
 - v) chemical processing;
 - vi) dry cleaning;
 - vii) slaughtering;
 - viii) butchering;
 - ix) smoking of food;
 - x) seafood processing;
 - xi) canning of foods with a pH level equal to or greater than 4.5;
 - xii) laundries;
 - xiii) manufacturing of fiberglass, pyroxlin or similar products;
 - xiv) paint, varnish, or lacquer manufacturing;
 - xv) primary processing including the processing of fence posts, shakes, and firewood;
 - xvi) rubber manufacturing;
 - xvii) tanneries;
 - xviii) funeral parlour;
 - xix) warehousing, specifically including mini-storage;
 - xx) marshalling of vehicles, equipment, and machinery;
 - xxi) vehicle wrecking or dismantling of vehicles;
 - xxii) spray painting shop;
 - xxiii) recycling facility;
 - xxiv) recreation facility;
 - xxv) sale of food and/or beverages for immediate consumption on or off the premises by an individual or household, and specifically including fast food outlets, neighbourhood pubs and restaurants, but not including breakfast served by a bed and breakfast to the traveling public who have been provided with overnight accommodation;²⁵
 - xxvi) taxidermy;
 - xxvii) dispensing of automotive fuel, oil, or fluids;
 - xxviii) automotive repairs, vehicle restoration or maintenance except on parcels zoned Agriculture 1 and 2 (AG1-AG2) and Rural 1 to 4 (RU1-RU4) and Rural 6 to 9 (RU6-RU9) and Resource Management 1 to 5 (RM1-RM5) and Resource Management 7 to 9 (RM7-RM9)²⁶;
 - xxix) cannabis production.^{27 28}

²⁵ Bylaw No. 500.286, adopted August 13, 2002

²⁶ Bylaw No. 500.402, adopted June 28, 2016

²⁷ Bylaw No. 500.415, adopted March 27, 2018

- c) A home based business must:
 - i) be conducted by the permanent residents of the parcel on which the home based business activity is located;
 - ii) be accessory to the residential use of the parcel;
 - iii) not change the outside appearance of the premises or create other visible evidence of its existence, other than one sign;
 - iv) be registered with the Regional District of Nanaimo Business Registry;
 - v) create no noise, vibration, glare, fumes, odours, dust, or smoke detectable off the parcel to the normal senses;
 - vi) be wholly contained within the dwelling unit, garage, and/or accessory building(s), except for outdoor play areas for child care facilities; and
 - vii) provide off street parking on the parcel for all non-resident employees.
- d) A maximum of one (1) non-illuminated home based business sign per parcel is permitted, provided that the sign:
 - i) does not exceed .75m² in sign face area;
 - ii) is displayed on the exterior wall face of a dwelling unit, accessory building or fence, or as a free standing sign;
 - iii) if freestanding, does not exceed 1.5 metres in height;
 - iv) if freestanding, is sited within required setbacks of the applicable zone.
- e) A maximum of one non-resident home based business employee is permitted per parcel or the part time equivalent thereof.
- f) Despite subsection e), a maximum of two non-resident home based business employees are permitted per parcel in all Residential 2 (RS2) zones, in Agriculture 1 and 2 (AG1– AG2) zones, Rural 1 to 4 (RU1-RU4), Rural 6 to 9 (RU6-RU9) zones, Resource Management 1 to 5 (RM1-RM5) and Resource Management 7 to 9 (RM7-RM9) zones.²⁹
- g) The location of a home based business is as follows:
 - i) For Residential 1 (RS1) parcels less than 2000 m² in area, all Residential 3 (RS3) parcels, and all Rural 5 (RU5) parcels, a home based business must be contained within the dwelling unit or attached garage, with the exception of outdoor play areas for child care facilities.
 - ii) In all other zones where a home based business is a permitted use, the home based business must be contained within the dwelling unit, attached garage or accessory buildings(s), with the exception of outdoor play areas for child care facilities.
- h) The maximum allowed home based business floor area is as follows:
 - i) On Residential 1 (RS1) parcels less than 2000 m², all Residential 3 (RS3) parcels, and Rural 5 (RU5) parcels, the home based business floor area must not exceed 49% of the combined total floor area of the dwelling unit and attached garage to a maximum of 100 m².

²⁸ Bylaw No. 500.387, adopted February 11, 2014

²⁹ Bylaw No. 500.402, adopted June 28, 2016

- ii) On Residential 1 (RS1) parcels greater than or equal to 2000 m² and all Residential 2 (RS2) parcels, the home based business floor area must not exceed 49% of the combined total floor area of the dwelling unit and attached garage to a maximum of 100 m², or a maximum of 100 m² combined total for dwelling unit, attached garage, and/or accessory building(s).
 - iii) On Agriculture 1 and 2 (AG1 – AG2), Rural 1 to 4 (RU1-RU4) and Rural 6 to 9 (RU6-RU9) parcels and Resource Management 1 to 5 (RM1-RM5) and Resource Management 6 to 9 (RM6-RM9) parcels, the home based business floor area must not exceed 49% of the combined total floor area of the dwelling unit and attached garage to a maximum of 150 m² or a maximum of 150 m² combined total floor area for the dwelling unit, attached garage, and/or accessory building(s).³⁰
- i) Home Based Business shall not be permitted within a secondary suite nor by the occupants of a secondary suite elsewhere on the subject property.
 - j) Bed and Breakfast shall not be permitted on a parcel that contains a suite.
 - k) Where a secondary suite is located on a parcel less than 4,000 m² in area, the Home Based Business must:
 - i) be limited to one (1) business; and,
 - ii) not include any non-resident home based business employees.³¹

15) **Farm Use Regulations**³²

On lands located within the Agricultural Land Reserve the following activities are permitted farm uses in accordance with the *Agricultural Land Reserve Use, Subdivision and Procedure Regulation* and are subject to the following regulations:

a) **Agri-Tourism**

Agri-tourism activities, other than accommodation, are permitted on land located within the Agricultural Land Reserve that is classified as 'farm' under the *BC Assessment Act*, if the use is temporary and seasonal, and promotes or markets farm products grown, raised or processed on the farm.

b) **Farm Retail Sales**

Farm retail sales is permitted on land located within the Agricultural Land Reserve if:

- i) All of the farm product offered for sale is produced on the farm on which the retail sales are taking place, or
- ii) At least 50% of the retail sales area is limited to the sale of farm products produced on the farm on which the retail sales is taking place and the total area,

³⁰ Bylaw No. 500.402, adopted June 28, 2016

³¹ Bylaw No. 500.389, adopted May 27, 2014

³² Bylaw No. 500.383, adopted June 25, 2013

both indoors and outdoors, used for the retail sales of all products does not exceed 300 m².

c) **Cannabis Production**

Cannabis production is permitted on land located within the Agricultural Land Reserve if:

- i) The production of cannabis is contained wholly within licensed facilities as permitted by the *Access to Cannabis for Medical Purposes Regulations* (ACMPR) and *Bill C-45* (the Cannabis Act).
- ii) The minimum setback for all structures associated with cannabis production is 30.0 metres from all property lines^{33, 34}

16) **Accessory Farm Use Regulations**³⁵

a) **Agriculture Education and Research**

Where agriculture education and research is permitted in this bylaw it shall be subject to the following regulations:

- i) the area occupied by any buildings or structures necessary for education or research must not exceed 100 m² for each parcel.

b) **Production of Biological Integrated Pest Management Products**

Where the production of biological integrated pest management products is permitted in this bylaw it shall be subject to the following regulations:

- i) the area occupied by any buildings or structures necessary for the production or development must not exceed 300 m² for each parcel.

c) **Agri-tourism Accommodation**³⁶

- i) As per Section 3 of the *Agricultural Land Reserve Use, Subdivision and Procedure Regulation*, on parcels within the Agricultural Land Reserve and where agri-tourism accommodation is a permitted accessory use, the following general provisions apply:
 - a. Agri-tourism accommodation use must be for rental only;
 - b. Agri-tourism accommodation is permitted only on land classified as 'farm' under the *BC Assessment Act*;
 - c. Four agri-tourism accommodation sleeping units shall be permitted on any parcel and one additional sleeping unit shall be permitted per hectare on

³³ Bylaw No. 500.415, adopted March 27, 2018

³⁴ Bylaw No. 500.387, adopted February 11, 2014

³⁵ Bylaw No. 500.402, adopted June 28, 2016

³⁶ Bylaw No. 500.383, adopted June 25, 2013

- parcels greater than or equal to 1.0 ha up to a maximum of ten (10) sleeping units per farm or parcel;
- d. When calculating the total number of agri-tourism accommodation sleeping units all forms of tourist accommodation, including a bed and breakfast, shall be included;
 - e. The total developed area for an agri-tourism accommodation use, including buildings, landscaping, driveways and parking shall occupy less than five percent (5%) of the total parcel area, in accordance with the Agricultural Land Commission Act.
- ii) An agri-tourism accommodation campground must be developed in accordance with the following regulations:
- a. Every campsite shall be unpaved and not exceed 150 m² in area;
 - b. Washroom and drinking water facilities shall be provided for in accordance with Island Health’s regulations and/or provincial regulations;
 - c. A maximum consecutive or non-consecutive stay of ninety (90) calendar days per visitor within any twelve (12) month period within any campsite on the parcel. The relocation of recreational vehicles (RVs) or campers to other sites within the parcel does not constitute the start of a new stay.
- iii) An agri-tourism accommodation cabin must be developed in accordance with the following regulations:
- a. The maximum gross floor area of an agri-tourism accommodation cabin shall not exceed 50 m²;
 - b. Washroom and drinking water facilities shall be provided for in accordance with Island Health’s regulations and/or provincial regulations;
 - c. A maximum of one kitchen facility shall be permitted within each agri-tourism accommodation cabin;
 - d. A maximum consecutive or non-consecutive stay of ninety (90) days per visitor in any twelve (12) month period within any cabin on the parcel. The relocation of a visitor to another cabin within the parcel does not constitute the start of a new stay;
 - e. One (1) parking space per agri-tourism accommodation cabin is required.
- d) Gathering for an Event³⁷**
- i) As per Section 1 of the *Agricultural Land Reserve Use, Subdivision and Procedure Regulation* on parcels within the Agricultural Land Reserve and where gathering for events is a permitted accessory use in this bylaw, the following general provisions apply:
 - a. The farm must be located on land classified as a farm under the *Assessment Act*;

³⁷ Bylaw No. 500.413, adopted May 22, 2018

- b. permanent facilities must not be constructed or erected in connection with the event;
- c. parking for those attending the event must be available on the farm, but must not be permanent nor interfere with the farm's agricultural productivity;
- d. no more than 150 people, excluding residents and employees of the farm, may be gathered on the farm at one time for the purpose of attending the event;
- e. the event must be of no more than 24 hours duration;
- f. maximum site area for events shall not exceed a combined total of 500 m²; and
- g. no more than 10 gatherings for an event of any type may occur on the farm within a single calendar year.

17) **Temporary Use Permits** ^{38 39 40}

1. The Regional District may issue a temporary use permit on any lot to temporarily allow a use not permitted by this bylaw. The following general conditions will guide the consideration of such applications. The Regional District may waive any of the following should they be deemed to not be relevant, and may give consideration to additional conditions relevant to the specific proposal.
 - i) The applicant demonstrates how any anticipated impact on the surrounding area will be mitigated (for example: noise, light, hours of operation, dust, odour, vibration, aesthetic impact, etc.).
 - ii) The applicant provides a projection of anticipated impact on local road networks, and proposes mitigating measures if necessary.
 - iii) The applicant provides an assessment of the impact of the proposed use on the natural environment, including groundwater, wildlife, and environmentally sensitive areas.
 - iv) The applicant provides a rationale for the suitability of the location and the inability to conduct the use in another area where the use is already permitted.
 - v) Submission of a satisfactory decommissioning and reclamation plan, which may require a security deposit to be held by the Regional District until completion of the proposed works.
 - vi) The proposal addresses concerns related to visual integrity and buffering of the Inland Island Highway if applicable.
 - vii) The proposed use is not a use referred to in section 2.
2. Notwithstanding clause 1 above, in some Official Community Plan areas, the issuance of a temporary use permit for specified uses is limited to specified designation as follows, and the following additional conditions will guide consideration of

³⁸ Bylaw No. 500.413, adopted May 22, 2018

³⁹ Bylaw No. 500.402, adopted June 28, 2016

⁴⁰ Bylaw No. 500.422, adopted December 4, 2018

applications. The Regional District may waive any of the following should they be deemed to not be relevant, and may give consideration to additional conditions relevant to the specific proposal.

Official Community Plan Area	Official Community Plan Designation	Use
Arrowsmith Benson – Cranberry Bright	Resource	<ul style="list-style-type: none"> • Primary processing of onsite aggregate or mineral resources • Manufacture of asphalt products • Commercial composting
East Wellington – Pleasant Valley	Resource	<ul style="list-style-type: none"> • Manufacture of asphalt products • Commercial composting solely for the purpose of reclaiming mined land
Nanoose Bay	Resource	<ul style="list-style-type: none"> • Manufacture of asphalt products • Gravel extraction • Commercial composting (only outside of the Agricultural Land Reserve)
Electoral Area G	Rural or Rural Resource	<ul style="list-style-type: none"> • Primary processing • Manufacture of asphalt products • Commercial composting • Concrete ready mix plant • Yard waste chipping

- i) lots are in excess of 8.0 hectares in area, or in Electoral Area G are in excess of 4.0 hectares in area;
- ii) the asphalt is produced in a portable asphalt batch plant;
- iii) approval is obtained from the province for an industrial access permit and a Waste Management approval pursuant to the *Waste Management Act*;
- iv) a separation distance, created by a natural vegetative buffer or berm, is maintained between the temporary use and any dwelling unit not located on the subject property. The width should be sufficient to provide a reasonable buffer to noise, dust and sight;
- v) a composting activity shall be no closer than 400 metres from the Growth Containment Boundary as identified in the Regional Growth Strategy.
- vi) where gravel removal and processing are required in conjunction with the manufacture of asphalt products, all requirements for the Approval of Work System and Reclamation Permit under the *Mines Act* including provisions for rehabilitation of the site after completion, are satisfied;
- vii) the daily period is limited to minimize noise impacts, including heavy truck traffic, on surrounding lands;
- viii) the use does not produce odours detectable from adjacent lots;

- ix) for composting, the uses comply with the provincial Organic Matter Recycling Regulations and any Regional District of Nanaimo Waste Stream Licensing Bylaw;
 - x) in Electoral Area G, consideration is given to future inclusion of the subject property and surrounding land into the City of Parksville or Qualicum Beach and the compatibility of future development with adjoining areas within each municipality.
3. Where the land is in the Agricultural Land Reserve, approval from the Provincial Agricultural Land Commission is required prior to issuance of a permit.
 4. The Regional District may specify conditions in a permit including, but not limited to, environmental protection measures, odour abatement, hours of operation, parking, buffering, and groundwater protection.
 5. The Regional District may require security and/or an undertaking to secure the conditions of the permit in accordance with the *Local Government Act*.

18) Pet Breeding or Boarding Facilities⁴¹

The establishment of a facility for breeding or boarding pets on ALR land is not permitted unless by a rezoning of land, except where permitted in this bylaw. The use, if approved, shall be subject to the following specific requirements as well as all other applicable provisions of this bylaw:

- a) Must be located on parcels which are 2.0 ha or larger,
- b) All structures and areas utilized in association with the breeding or boarding facility shall be sited a minimum of 30.0 metres from all property lines.

19) Secondary Suites⁴²

- a) Secondary suites shall be permitted in the following zone classifications: AG143, RS1, RS1.1, RS2, and RU1 – RU10 (Inclusive).
- b) A maximum of one (1) secondary suite is permitted per single dwelling unit to a maximum of two (2) per parcel of which only one (1) may be detached.
- c) Notwithstanding Section 2.1, a secondary suite shall be permitted within an accessory building.
- d) Secondary Suites shall be subject to the following requirements:
 - i) secondary suites within a principal dwelling unit must not exceed 40% of the habitable floor space of the building that it is located in nor 90 m² of total floor space, whichever is lesser;
 - ii) must not be located within a duplex, manufactured home, or multiple dwelling unit development;

⁴¹ Bylaw No. 500.402, adopted June 28, 2016

⁴² Bylaw No. 500.389, adopted May 27, 2014

⁴³ Bylaw No. 500.402, adopted June 28, 2016

- iii) must provide at least two (2) additional designated off-street parking spaces (at least one (1) must have direct access to the street);
 - iv) shall be maintained in the same real estate entity as the principal dwelling unit to which it is accessory;
 - v) must meet minimum setback requirements for a dwelling unit located in the applicable Zone Classification.
 - vi) must be limited to a maximum of two bedrooms and one cooking facility;
 - vii) must, on parcels without community sewer services, have the approval of the local Health Authority with respect to the provision of sewage disposal;
 - viii) must have its own entrance separate from that of the principal dwelling unit; and,
 - ix) must not be used for short term (less than one month) rentals.
- e) A Secondary Suite may be located within an accessory building subject to the following:
- i) The minimum site area requirement shall be 800 m² for parcels serviced with community water and community sewer or 8,000 m² in all other cases.
 - ii) Notwithstanding any other provision in this Bylaw, the maximum height of a building containing a suite shall be 8.0 metres;
 - iii) The maximum floor area of an accessory building containing a secondary suite shall not exceed 40% of the habitable floor space of the principal dwelling unit which it is associated with nor 90 m² of total floor space, whichever is lesser.
 - iv) the secondary suite shall contain no interior access to any part of the accessory building and the means of access and egress must be external to the structure.
- f) Home Based Business shall be in accordance with Section 3.3.14.
- g) Despite any regulation in this Bylaw, land established as “Agricultural Land Reserve” pursuant to the ***Agricultural Land Reserve Act*** is subject to the ***Agricultural Land Reserve Act*** and ***Regulations***, and applicable orders of the Land Reserve Commission.

3.4 Regulations for Each Zone

Detailed regulations respecting each zone can be found in Section 3.4.⁴⁴

⁴⁴ Bylaw No. 500.402, adopted June 28, 2016

Section 3.4.1

AGRICULTURE 1

AG1⁴⁵⁴⁶

3.4.1.1 Permitted Uses and Minimum Site Area

Permitted Principal Uses

- a) Farm Use – on lands located in the Agricultural Land Reserve
- b) Agriculture – on lands not located in the Agricultural Land Reserve
- c) Residential Use

Permitted Accessory Residential Uses

- a) Home Based Business
- b) Secondary Suite

Permitted Accessory Farm Uses

- a) Temporary Sawmill
- b) Agricultural Education and Research
- c) Agri-tourism Accommodation
- d) Production of Biological Integrated Pest Management Products
- e) Gathering for an Event⁴⁷

3.4.1.2 Maximum Number and Size of Buildings and Structures

- 1) Accessory residential buildings combined floor area of 400 m²
- 2) Dwelling units/parcel
 - a) on a parcel having an area of 2.0 ha or less 1
 - For Electoral Areas 'A', 'C', 'E', and 'H'**
 - b) on a parcel having an area greater than 2.0 ha 2
 - For Electoral Area 'G'**
 - c) on a parcel having an area equal to or greater than twice the minimum parcel size as established by Schedule '4B Subdivision District – Minimum Parcel Sizes' 2

⁴⁵ Bylaw No.500.383, Adopted June 25, 2013

⁴⁶ Bylaw No. 500.402, adopted June 28, 2016

⁴⁷ Bylaw No. 500.413, adopted May 22, 2018

AGRICULTURE 1 continued

- d) Notwithstanding subsection (c), on a parcel located in this zone and created prior to February 22, 2011 and having an area greater than 2.0 ha. 2
 - 3) Height (non-farm and accessory farm buildings and structures) 9.0 m
 - 4) Parcel coverage
 - a) Non-farm buildings and structures 10%
 - b) Farm or agriculture buildings and structures 25%
 - c) Greenhouses 75%
 - d) In no case shall the combined parcel coverage exceed 75%.
 - e) Notwithstanding a), b), c) and d) above or any other regulation in this Bylaw, the following agricultural structures shall be exempt from maximum parcel coverage:
 - i) Permeable detention ponds
 - ii) Support structures used for shading, frost and wind protection, netting, or trellising.
-

3.4.1.3 Minimum Setback Requirements

- 1) All non-farm buildings and structures – All lot lines 8.0 m
except where:
 - a) the parcel is less than 4000 m² in area then the setback from lot lines may be reduced to 2.0 m from an interior side lot line and to 5.0 m from other lot lines, excluding the front lot line;
 - b) any part of a parcel is adjacent to or contains a watercourse or the sea then the regulations in Sections 3.3.8 and 3.3.9 shall apply.
 - 2) All agriculture or farm buildings, structures and uses – in accordance with Section 3.3.10.
-

3.4.1.4 Other Regulations

- 1) For any part of a parcel in the Agricultural Land Reserve, 'Farm Use' shall be a permitted principal use and for any part of a parcel not located in the Agricultural Land Reserve, 'Agriculture' shall be a permitted principal use.
- 2) Accessory Farm uses are only permitted on that part of a parcel that is within the Agricultural Land Reserve.
- 3) Specific 'Farm' and 'Permitted' uses as defined in the ***Agricultural Land Reserve Use, Subdivision, and Procedure Regulation*** shall be developed in accordance with Section 3.3.15 and 3.3.16 of this Bylaw.
- 4) Despite any regulation in this Bylaw, land established as "Agricultural Land Reserve" pursuant to the ***Agricultural Land Commission Act*** is subject to the ***Agricultural Land Commission Act*** and ***Regulations***, and applicable orders of the Land Reserve Commission.

AGRICULTURE 1 continued

- 7) Office and file/urn storage accessory to the cemetery shall be permitted in accordance with ALC non-farm use approval in the shaded area outlined in bold in the map below.⁴⁸

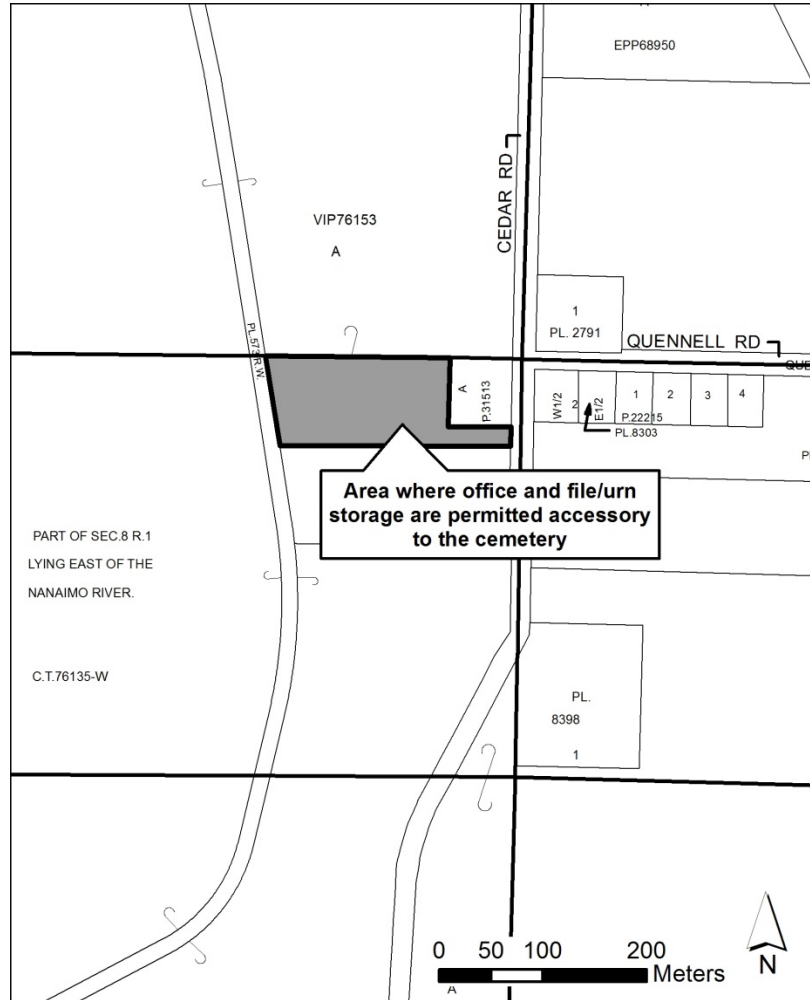

⁴⁸ Bylaw 500.412, adopted March 27, 2018

Section 3.4.2

AGRICULTURE 2

AG2⁴⁹

3.4.2.1 Permitted Uses and Minimum Site Area

Permitted Principal Uses	Required Site Area:
a) Farm Use – on lands located in the Agricultural Land Reserve	n/a
b) Agriculture – on lands not located in the Agricultural Land Reserve	n/a
c) Residential Use	n/a
d) Extraction Use	2.0 ha
e) Log Storage and Sorting Yard	1.0 ha
f) Primary Processing	5.0 ha

Permitted Accessory Residential Uses

- a) Home Based Business

Permitted Accessory Farm Uses

- a) Temporary Sawmill
- b) Agricultural Education and Research
- c) Agri-tourism Accommodation
- d) Production of Biological Integrated Pest Management Products
- e) Gathering for an Event⁵⁰

3.4.2.2 Maximum Number and Size of Buildings and Structures

1) Accessory residential buildings	combined floor area of 400 m ²
2) Dwelling units/parcel	
a) on a parcel having an area of 8.0 ha or less	1
For Electoral Areas 'A', 'C', 'E', and 'H'	
b) on a parcel having an area of 8.0 ha or more	2
For Electoral Area 'G' only	
c) on a parcel having an area equal to or greater than twice the minimum parcel size as established by Schedule '4B Subdivision District – Minimum Parcel Sizes'	2

⁴⁹ Bylaw No. 500.402, adopted June 28, 2016

⁵⁰ Bylaw No. 500.413, adopted May 22, 2018

AGRICULTURE 2 continued

- d) Notwithstanding subsection (c), on a parcel located in this zone and created prior to February 22, 2011 and having an area greater than 8.0 ha 2
- 3) Height (non-farm and accessory farm buildings and structures) 9.0 m
- 4) Parcel coverage
 - a) Non-farm or non-agricultural buildings and structures 10%
 - b) Farm or agriculture buildings and structures 25%
 - c) Greenhouses 75%
 - d) In no case shall the combined parcel coverage exceed 75%
 - e) Notwithstanding a), b), c) and d) above or any other regulation in this Bylaw, the following agricultural structures shall be exempt from maximum parcel coverage:
 - i) Permeable detention ponds
 - ii) Support structures used for shading, frost and wind protection, netting, or trellising.

3.4.2.3 Minimum Setback Requirements

- 1) All residential and non-farm buildings and structures:
 - a) All residential buildings and structures – All lot lines 8.0 m
 - b) All other non-farm buildings and structures – All lot lines 20.0 m
 - c) Except where any part of a parcel is adjacent to or contains a watercourse or the sea then the regulations in Sections 3.3.8 and 3.3.9 shall apply
- 2) All agriculture or farm buildings, structures and uses – in accordance with Section 3.3.10.

3.4.2.4 Other Regulations

- 1) For any part of a parcel in the Agricultural Land Reserve, 'Farm Use' shall be a permitted principal use and for any part of a parcel not located in the Agricultural Land Reserve, 'Agriculture' shall be a permitted principal use.
- 2) Accessory Farm uses are only permitted on that part of a parcel that is within the Agricultural Land Reserve.
- 3) Specific 'Farm' and 'Permitted' uses as defined in the ***Agricultural Land Reserve Use, Subdivision, and Procedure Regulation*** shall be developed in accordance with Section 3.3.15 and 3.3.16 of this Bylaw.
- 4) Despite any regulation in this Bylaw, land established as "Agricultural Land Reserve" pursuant to the ***Agricultural Land Commission Act*** is subject to the ***Agricultural Land Commission Act*** and ***Regulations***, and applicable orders of the Land Reserve Commission.

Section 3.4.11

COMMERCIAL 1

CM1

Permitted Uses and Minimum Site Area

Permitted Uses	Required Site Area with:		
	Community Water & Sewer System	Community Water System	No Community Services
Convenience Store	800 m ²	1600 m ²	2400 m ²
Office	500 m ²	1000 m ²	1500 m ²
Residential Use ¹	500 m ²	500 m ²	500 m ²
Restaurant	2000 m ²	4000 m ²	6000 m ²

Maximum Number and Size of Buildings and Structures

Dwelling units/parcel ²	- 1
Floor area ratio	- 0.40
Height	- 8.0 m
Parcel coverage	- 40%

Minimum Setback Requirements

Front lot line	- 8.0 m
Other lot lines	- 5.0 m

except where:

- a) the adjoining parcel is zoned industrial or commercial then the setback from the common interior side lot line may be reduced to zero;
- b) any part of a parcel is adjacent to or contains a watercourse then the regulations in Section 3.3.8 shall apply.

¹ Bylaw No. 500.13, adopted October 13, 1987

² Bylaw No. 500.13, adopted October 13, 1987

Section 3.4.12

COMMERCIAL 2**CM2****Permitted Uses and Minimum Site Area**

Required Site Area with:

Permitted Uses	Community Water & Sewer System	Community Water System	No Community Services
a) Funeral Parlour	2000 m ²	4000 m ²	6000 m ²
b) Gas Bar	1000 m ²	1600 m ²	2000 m ²
c) Nursery	4000 m ²	5000 m ²	8000 m ²
d) Office	500 m ²	1000 m ²	1500 m ²
e) Personal Service Use	800 m ²	1600 m ²	2400 m ²
f) Recreation Facility	4000 m ²	5000 m ²	8000 m ²
g) Restaurant	2000 m ²	4000 m ²	6000 m ²
h) Retail Store	1000 m ²	1600 m ²	2000 m ²

Accessory Uses

a) Residential Use ¹	n/a	n/a	n/a
---------------------------------	-----	-----	-----

Maximum Number and Size of Buildings and Structures

Dwelling units/parcel ²	- 1
Floor area ratio	- 0.75
Height	- 8.0 m
Parcel coverage	- 50%

Minimum Setback Requirements

Front lot line	- 8.0 m
Other lot lines	- 5.0 m

except where:

- a) the adjoining parcel is zoned industrial or commercial then the setback from the common interior side lot line may be reduced to zero;
- b) any part of a parcel is adjacent to or contains a watercourse then the regulations in Section 3.3.8 shall apply.

¹ Bylaw No. 500.282, adopted June 11, 2002² Bylaw No. 500.13, adopted October 13, 1987

Section 3.4.12.1¹**COMMERCIAL 2.1****CM2.1****Permitted Uses and Minimum Site Area**

Required Site Area with:

Permitted Uses	Community Water & Sewer System	Community Water System	No Community Services
i) Funeral Parlour	2000 m ²	4000 m ²	6000 m ²
j) Gas Bar	1000 m ²	1600 m ²	2000 m ²
k) Nursery	4000 m ²	5000 m ²	8000 m ²
l) Office	500 m ²	1000 m ²	1500 m ²
m) Personal Service Use	800 m ²	1600 m ²	2400 m ²
n) Recreation Facility	4000 m ²	5000 m ²	8000 m ²
o) Restaurant	2000 m ²	4000 m ²	6000 m ²
p) Retail Store	1000 m ²	1600 m ²	2000 m ²
q) Automotive Repair	1000 m ²	1600 m ²	2000 m ²

Accessory Uses

a) Residential Use	n/a	n/a	n/a
b) Vehicle Sales	n/a	n/a	n/a

Maximum Number and Size of Buildings and Structures

Dwelling units/parcel	1
Floor area ratio	0.75
Height	11.0 m
Parcel coverage	50%

Minimum Setback Requirements

Front and Other lot lines 4.5 m

except where:

- c) in the case of unenclosed covered entryways, roof overhangs, and canopies the Front and Other lot lines may be reduced to 2.0 metres;
- d) the adjoining parcel is zoned industrial or commercial then the setback from the common interior side lot line may be reduced to zero;
- e) any part of a parcel is adjacent to or contains a watercourse then the regulations in Section 3.3.8 shall apply.

¹ Bylaw No. 500.408, adopted August 22, 2017

Other Regulations

For the purpose of this zone:

- a) Vehicle sales:
 - i shall be limited to a maximum of two vehicles for sale on a parcel at any one time;
 - ii shall not be located within the minimum setback requirements of this zone; and,
 - iii shall require a minimum of 1 additional off-street parking space.

- b) Despite any other regulation in this bylaw, parking and loading spaces:
 - i. shall be permitted within the applicable minimum setback requirements;
 - ii. despite (i.) above, shall not be located within the minimum setback requirement adjacent to Cedar Road or within the minimum setback requirement adjacent to any parcel which is zoned residential.

Section 3.4.13

COMMERCIAL 3

CM3

Permitted Uses and Minimum Site Area

Required Site Area with:

Permitted Uses	Community Water & Sewer System	Community Water System	No Community Services
a) Gasoline Service Station	4000 m ²	5000 m ²	8000 m ²
b) Nursery	4000 m ²	5000 m ²	8000 m ²
c) Outdoor Sales	4000 m ²	5000 m ²	8000 m ²
d) Residential Use ¹	n/a	n/a	n/a
e) Retail Store	1000 m ²	1600 m ²	2000 m ²
f) Shopping Centre	5.0 ha	5.0 ha	5.0 ha

Maximum Number and Size of Buildings and Structures

Dwelling units/parcel ²	- 1
Floor area ratio	- 0.10
Height	- 8.0 m
Parcel coverage	- 20%

Minimum Setback Requirements

All lot lines	- 8.0 m
---------------	---------

except where any part of a parcel is adjacent to or contains a watercourse then the regulations in Section 3.3.8 shall apply.

¹ Bylaw No. 500.13, adopted October 13, 1987

² Bylaw No. 500.13, adopted October 13, 1987

Section 3.4.14

COMMERCIAL 4**CM4****Permitted Uses and Minimum Site Area**

Required Site Area with:

Permitted Uses	Community Water & Sewer System	Community Water System	No Community Services
a) Fairground	1.0 ha	1.0 ha	2.0 ha
b) Fast Food Outlet	2000 m ²	4000 m ²	6000 m ²
c) Gasoline Service Station	4000 m ²	5000 m ²	8000 m ²
d) Nursery	4000 m ²	5000 m ²	8000 m ²
e) Outdoor Sales	4000 m ²	5000 m ²	8000 m ²
f) Produce Market	4000 m ²	5000 m ²	8000 m ²
g) Public Assembly	4000 m ²	5000 m ²	8000 m ²
h) Recreation Facility	4000 m ²	5000 m ²	8000 m ²
i) Residential Use ¹	n/a	n/a	n/a
j) Restaurant	2000 m ²	4000 m ²	6000 m ²
k) Retail Store	1000 m ²	1600 m ²	2000 m ²

Maximum Number and Size of Buildings and Structures

Dwelling units/parcel ²	- 1
Floor area ratio	- 0.60
Height	- 8.0 m
Parcel coverage	- 50%

Minimum Setback Requirements

Front lot line	- 8.0 m
Other lot lines	- 5.0 m

except where:

- the adjoining parcel is zoned industrial or commercial then the setback from the common interior side lot line may be reduced to zero;
- any part of a parcel is adjacent to or contains a watercourse then the regulations in Section 3.3.8 shall apply.

¹ Bylaw No. 500.13, adopted October 13, 1987² Bylaw No. 500.13, adopted October 13, 1987

Section 3.4.15

COMMERCIAL 5¹**CM5****Permitted Uses and Minimum Site Area**

Required Site Area with:

Permitted Uses	Community Water & Sewer System	Community Water System	No Community Services
a) Hotel			
First Unit	2000 m ²	2000 m ²	4000 m ²
Each Additional Unit	200 m ²	400 m ²	400 m ²
b) Resort Condominium Unit	400 m ²	1000 m ²	4000 m ²
c) Marina	5000 m ²	5000 m ²	1.0 ha
d) Neighbourhood Pub	2000 m ²	4000 m ²	6000 m ²
e) Public Assembly Use	4000 m ²	5000 m ²	8000 m ²
f) Recreation Facility	4000 m ²	5000 m ²	8000 m ²
g) Residential Use ²	n/a	n/a	n/a
h) Restaurant	2000 m ²	4000 m ²	6000 m ²
i) Resort Vehicle Park ³	400 m ²	400 m ²	400 m ²
j) Tourist Information Booth	500 m ²	500 m ²	500 m ²
k) Tourist Store	800 m ²	1600 m ²	2000 m ²

Maximum Number and Size of Buildings and Structures

Resort Vehicle Park ⁴	25 camping spaces/ha to a maximum of 150 camping spaces per parcel developed in accordance with Schedule '3C', 'Campground Regulations and Standards'
Dwelling units/parcel ⁵	- 1
Floor area ratio	- 0.60
Height	- 8.0 m
Parcel coverage	- 40%

¹ Bylaw No. 500.74, adopted October 8, 1991² Bylaw No. 500.13, adopted October 13, 1987³ Bylaw No. 500.162, adopted April 8, 1997⁴ Bylaw No. 500.162, adopted April 8, 1997⁵ Bylaw No. 500.13, adopted October 13, 1987

COMMERCIAL 5 continued

Minimum Setback Requirements

Front lot line - 8.0 m

Other lot lines - 5.0 m

except where:

- a) the adjoining parcel is zoned industrial or commercial then the setback from the common interior side lot line may be reduced to zero;
- b) any part of a parcel is adjacent to or contains a watercourse then the regulations in Section 3.3.8 shall apply.

Section 3.4.16

COMMERCIAL 6¹**CM6****Permitted Uses and Minimum Site Area**

Permitted Uses	Required Site Area with:		
	Community Water & Sewer System	Community Water System	No Community Services
a) Hotel			
First Unit	3000 m ²	4000 m ²	4000 m ²
Each Additional Unit	100 m ²	400 m ²	400 m ²
b) Resort Condominium Development			
First Unit	3000 m ²	1000 m ²	4000 m ²
Each Additional Unit	100 m ²	1000 m ²	4000 m ²
c) Neighbourhood Pub	2000 m ²	4000 m ²	6000 m ²
d) Office	500 m ²	1000 m ²	1500 m ²
e) Personal Service Use	800 m ²	1600 m ²	2400 m ²
f) Public Assembly Use	4000 m ²	5000 m ²	8000 m ²
g) Recreation Facility	4000 m ²	5000 m ²	8000 m ²
h) Residential Use ²	500 m ²	1000 m ²	1500 m ²
i) Restaurant	2000 m ²	4000 m ²	6000 m ²
j) Retail Store	1000 m ²	1600 m ²	2000 m ²

Maximum Number and Size of Buildings and Structures

Dwelling units/parcel ³	- 1
Floor area ratio	- 0.75
Height	- 8.0 m
Parcel coverage	- 60%

¹ Bylaw No. 500.74, adopted October 8, 1991² Bylaw No. 500.13, adopted October 13, 1987³ Bylaw No. 500.13, adopted October 13, 1987

COMMERCIAL 6 continued

Minimum Setback Requirements

Front lot line - 8.0 m

Other lot lines - 5.0 m

except where:

- a) the adjoining parcel is zoned industrial or commercial then the setback from the common interior side lot line may be reduced to zero;
- b) any part of a parcel is adjacent to or contains a watercourse then the regulations in Section 3.3.8 shall apply.

Section 3.4.17

COMMERCIAL 7¹

CM7

Permitted Uses and Minimum Site Area

Required Site Area with:

Permitted Uses	Community Water & Sewer System	No Community Services
Office	500 m ²	1000 m ²
Personal Service Use	500 m ²	
Residential Use	n/a	n/a

Maximum Number and Size of Buildings and Structures

Dwelling units/parcel	- 1
Floor area ratio	- 0.2
Height	- 8.0 m
Parcel coverage	- 20%

Notwithstanding the Floor Area Ratio noted in this zone, an additional FAR of 0.1 is permitted within a building or structure for “office” use, up to a total maximum FAR of 0.3 for the property legally described as Lot 36, District Lot 6, Nanoose District, Plan 23588.²

Minimum Setback Requirements

Front lot line	8.0 m
Interior side lot lines	2.0 m
Rear lot line	2.0 m
Exterior side lot line	5.0 m

except where:

- a) the adjoining parcel is zoned industrial or commercial then the setback from the common interior side lot line may be reduced to zero;
- b) any part of a parcel is adjacent to or contains a watercourse then the regulations in Section 3.3.8 shall apply.

¹ Bylaw No. 500.273, adopted May 8, 2001

² Bylaw No. 500.380, adopted March 26, 2013

Section 3.4.18

RESORT COMMERCIAL¹

RCM

Permitted Uses and Minimum Site Area

Required Site Area with:

Permitted Uses

a) Tourist Store	2000 m ²
b) Residential Use	500 m ²
c) Outdoor Recreation	10000 m ²
d) Resort Vehicle Park	400 m ²
e) Recreation Facility	8000 m ²
f) Gas Bar on the land identified on Illustration No. 1 and 2 below	8000 m ²
g) Gasoline Service Station on the land identified on Illustration 3 below	2000 m ²
Dwelling units/parcel	1
Floor area ration	0.6
Height	9.0
Parcel Coverage	40%
Resort Vehicle Park	25 camping spaces/ha to a maximum of 150 camping spaces per parcel developed in accordance with Schedule '3C', 'Campground Regulations and Standards'.

Minimum Setback Requirements

Front lot line	8.0 m
Other lot line	5.0 m

except where:

- a) the adjoining parcel is zoned industrial or commercial then the setback from the common interior side lot line may be reduced to zero;
- b) any part of a parcel is adjacent to or contains a watercourse then the regulations in Section 3.3.8 shall apply.

¹ Bylaw No. 500.362, adopted January 25, 2011

Illustration No. 1 – Gas Bar is permitted on the property shown below

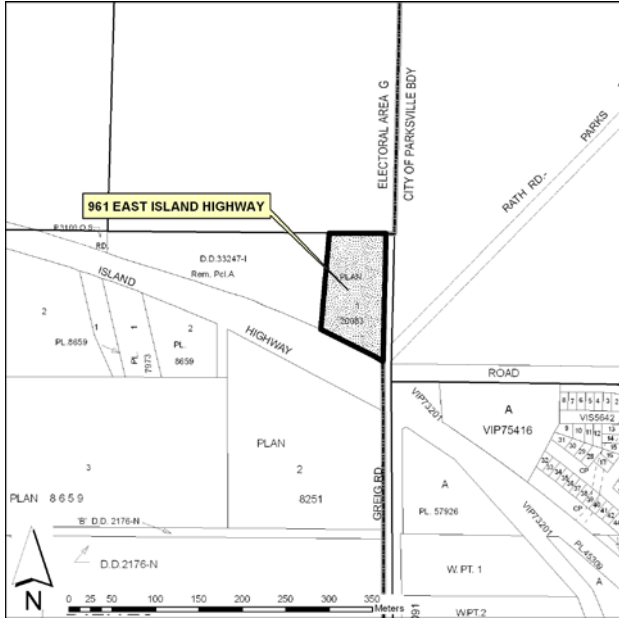

Illustration No. 2 – Gas Bar is permitted on the property shown below

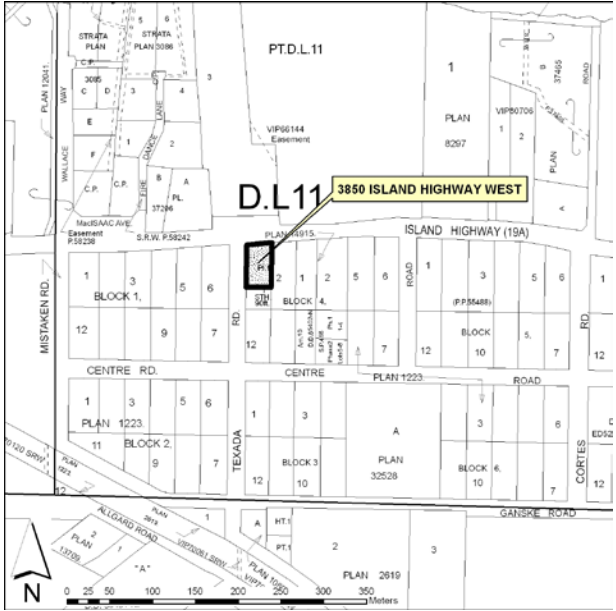
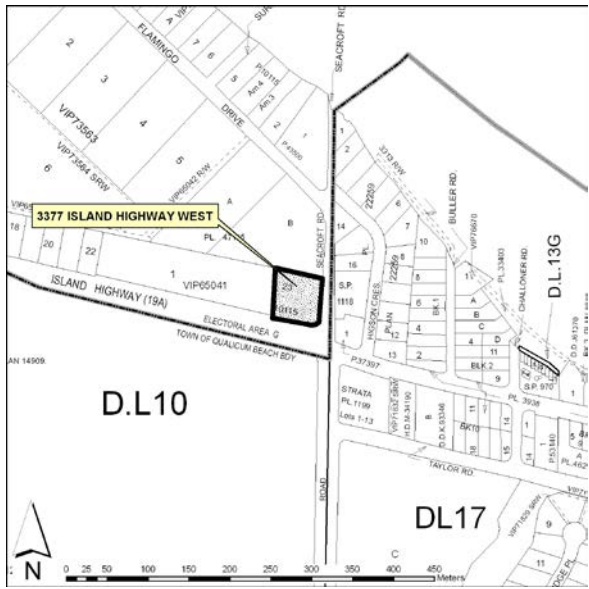

Illustration No. 3 – Gasoline Service Station is permitted on the property shown below



Section 3.4.19

COMMERCIAL 8¹

CM8

3.4.19.1 Permitted Uses & Density

Permitted Uses

- a) Campground Use
 - b) Residential Use
 - c) Agriculture
-

3.4.19.2 Maximum Number and Size of Buildings and Structures

Number of Camping Spaces	Camping spaces shall be developed in accordance with Schedule '3C' – Campground Regulations.
Dwelling units/parcel	1
Maximum Height of buildings	<ul style="list-style-type: none">a. 8.0 m above the 200 year designated flood level for all buildings and structures subject to the flood construction level requirements of "Regional District of Nanaimo Floodplain Management Bylaw No. 1469, 2006".b. 8.0 metres above the natural grade for all buildings and structures exempt from the flood construction level requirements of "Regional District of Nanaimo Floodplain Management Bylaw No. 1469, 2006".c. Notwithstanding (a) and (b) above, in the case where a building or structure exempt from the flood construction level requirements of "Regional District of Nanaimo Floodplain Management Bylaw No. 1469, 2006" is proposed to constructed above the 200 year designated flood level, the maximum height shall be 8.0 metres above the 200 year designated flood level.
Maximum Parcel coverage	10 %

3.4.19.3 Minimum Setback Requirements

For all buildings and structures:

Front Lot line	8.0 metres
All other lot lines	5.0 metres
Lot lines adjacent to the Englishman River	The regulations of Section 3.3.8 apply

3.4.19.4 Minimum Parcel Size

2.0 hectares

¹ Bylaw No. 500.362, adopted January 25, 2011

COMMERCIAL 8 continued

3.4.19.5 Other Regulations

For the purpose of this zone:

- a) In this zone Campground Use means the use of a parcel for providing temporary accommodation for travelers who stay no more than 60 days in a calendar year using tents or recreational vehicles, but specifically excludes a mobile home park or hotel. The following uses shall be permitted in conjunction with and accessory to a campground use: retail sales up to a maximum of 100 m² of floor area, public assembly, non-motorized recreational vehicle rentals, concession stand, and recreational use.
- b) Non-Motorized Recreational Vehicle Rentals means the use of land, and or a building or structure not exceeding a maximum floor area of 100 m² for the purpose of renting non-motorized recreational vehicles and equipment and may include accessory guiding and lessons.
- c) Concession Stand means the use of a building or structure not exceeding 15 m² in floor area not including outdoor eating and sitting areas for the sale of food and beverages to be consumed on the subject property, but specifically excludes neighbourhood pub and fast food outlet.
- d) Recreational Use means the use of land for the conduct of outdoor sports and outdoor leisure activities which may include accessory buildings and structures in association with a recreational use.
- e) Intensive Agricultural Uses including feed lot, fur farm, mushroom farm, horse boarding stable, and intensive swine operation are not permitted in this zone.
- f) All Recreational Vehicles shall be licensed for use on public roads, have wheels, have no structural skirting, and have no associated decks, patios, additions, or other structural improvements.
- g) The 200 year designated flood level shall be determined by interpretation of the "Province of British Columbia, Ministry of Environment – Water Management Branch Floodplain Mapping - Englishman River, drawing number 83-23-1,1980" and may be groundtruthed by a registered hydrologist or geotechnical engineer qualified to determine site specific flood construction levels to determine building-site specific flood construction levels.

Section 3.4.21

CONSERVATION 1

ES1

Permitted Uses and Minimum Site Area

Permitted Uses	Required Site Area with:		
	Community Water & Sewer System	Community Water System	No Community Services
a) Historic, Natural or Archaeological Site	n/a	n/a	n/a
b) Residential Use ¹	n/a	n/a	n/a

Maximum Number and Size of Buildings and Structures

Dwelling units/parcel ²	- 1	
Height	- 8.0 m	applicable to buildings and structures intended for residential use
Parcel coverage	- 20%	applicable to buildings and structures intended for residential use

Minimum Setback Requirements

Buildings and structures intended for residential use:

All lot lines - 8.0 m

except where any parcel is adjacent to or contains a watercourse then the regulations in Section 3.3.8 shall apply.

¹ Bylaw No. 500.13, adopted October 13, 1987

² Bylaw No. 500.13, adopted October 13, 1987

Section 3.4.31

INDUSTRIAL 1

IN1

Permitted Uses and Minimum Site Area

Required Site Area with:

Permitted Uses	Community Water & Sewer System	Community Water System	No Community Services
a) Light Industry	4000 m ²	5000 m ²	8000 m ²
b) Heavy Equipment Display	4000 m ²	5000 m ²	8000 m ²
c) Residential Use ¹	n/a	n/a	n/a
d) Notwithstanding the Required Site Area, for the property legally described as Lot C, Sections 11 and 12, Range 7, Cranberry District, Plan 21786 both 'Light Industry' and 'Heavy Equipment Display' are permitted uses. ²			

Maximum Number and Size of Buildings and Structures

Dwelling units/parcel ³	- 1
Height	- 8.0 m
Parcel coverage	- 60%

Minimum Setback Requirements

Front lot line	- 8.0 m
Other lot lines	- 5.0 m

except where:

- a) the adjoining parcel is zoned industrial or commercial then the setback from the common interior side lot line may be reduced to zero;
- b) any part of a parcel is adjacent to or contains a watercourse then the regulations in Section 3.3.8 shall apply.

¹ Bylaw No. 500.13, adopted October 13, 1987

² Bylaw No. 500.357, adopted February 22, 2011

³ Bylaw No. 500.13, adopted October 13, 1987

Section 3.4.32

INDUSTRIAL 2

IN2

Permitted Uses and Minimum Site Area

Permitted Uses	Required Site Area with:		
	Community Water & Sewer System	Community Water System	No Community Services
a) Medium Industry ¹	4000 m ²	6000 m ²	1.0 ha
b) Residential Use ²	n/a	n/a	n/a

Maximum Number and Size of Buildings and Structures

Dwelling units/parcel ³	- 1
Height	- 8.0 m
Parcel coverage	- 45%

Minimum Setback Requirements

All lot lines	- 10.0 m
---------------	----------

except where any part of a parcel is adjacent to or contains a watercourse then the regulations in Section 3.3.8 shall apply.

¹ Bylaw No. 500.27, adopted August 9, 1988

² Bylaw No. 500.13, adopted October 13, 1987

³ Bylaw No. 500.13, adopted October 13, 1987

Section 3.4.33

INDUSTRIAL 3

IN3

Permitted Uses and Minimum Site Area

Required Site Area with:

Permitted Uses	Community Water & Sewer System	Community Water System	No Community Services
a) Marshaling Yard	1.0 ha	1.0 ha	1.0 ha
b) Residential Use ¹	n/a	n/a	n/a
c) Shipping Yard	1.0 ha	1.0 ha	1.0 ha
d) Transportation Terminal	5000 m ²	8000 m ²	1.0 ha

Maximum Number and Size of Buildings and Structures

Dwelling units/parcel ²	- 1
Height	- 8.0 m
Parcel coverage	- 45%

Minimum Setback Requirements

All lot lines	- 10.0 m
---------------	----------

except where any part of a parcel is adjacent to or contains a watercourse then the regulations in Section 3.3.8 shall apply.

¹ Bylaw No. 500.13, adopted October 13, 1987

² Bylaw No. 500.13, adopted October 13, 1987

Section 3.4.34

INDUSTRIAL 4

IN4

Permitted Uses and Minimum Site Area

Permitted Uses	Required Site Area with:		
	Community Water & Sewer System	Community Water System	No Community Services
a) Explosives Manufacturing	8.0 ha	8.0 ha	8.0 ha
b) Residential Use ¹	n/a	n/a	n/a

Maximum Number and Size of Buildings and Structures

Dwelling units/parcel ²	- 1
Height	- 12.0 m
Parcel coverage	- 20%

Minimum Setback Requirements

All lot lines - 10.0 m

except where any part of a parcel is adjacent to or contains a watercourse then the regulations in Section 3.3.8 shall apply.

¹ Bylaw No. 500.13, adopted October 13, 1987

² Bylaw No. 500.13, adopted October 13, 1987

Section 3.4.35

INDUSTRIAL 5

IN5

Permitted Uses and Minimum Site Area

Permitted Uses	Required Site Area with:		
	Community Water & Sewer System	Community Water System	No Community Services
a) Heavy Industry	2.0 ha	2.0 ha	2.0 ha
b) Residential Use ¹	n/a	n/a	n/a

Maximum Number and Size of Buildings and Structures

Dwelling units/parcel ²	- 1
Height	- 8.0 m
Parcel coverage	- 20%

Minimum Setback Requirements

All lot lines - 10.0 m

except where any part of a parcel is adjacent to or contains a watercourse then the regulations in Section 3.3.8 shall apply.

¹ Bylaw No. 500.13, adopted October 13, 1987

² Bylaw No. 500.13, adopted October 13, 1987

Section 3.4.41

PUBLIC 1

PU1

Permitted Uses and Minimum Site Area

Required Site Area with:

Permitted Uses	Community Water & Sewer System	Community Water System	No Community Services
a) Personal Care	4000 m ²	5000 m ²	8000 m ²
b) Personal Care Unit	400 m ²	1600 m ²	1.0 ha
c) Public Assembly Use	4000 m ²	5000 m ²	8000 m ²
d) Public Utility Use	500 m ²	1000 m ²	1500 m ²
e) Residential Use ¹	n/a	n/a	n/a
f) School	4000 m ²	5000 m ²	8000 m ²

Notwithstanding the provisions outlined above, the following Accessory Use shall be permitted in conjunction with a school for the parcel legally described as Lot A, District Lot 7, Bright District, Plan 30903:

School Accomodation, as defined in this zone².

Maximum Number and Size of Buildings and Structures

Dwelling units/parcel ³	- 1
Height	- 8.0 m
Parcel coverage	- 50% ⁴

Minimum Setback Requirements

Front lot line	- 8.0 m
Other lot lines	- 5.0 m

except where any part of a parcel is adjacent to or contains a watercourse then the regulations in Section 3.3.8 shall apply.

¹ Bylaw No. 500.13, adopted October 13, 1987

² Bylaw No. 500.375, adopted October 23, 2012

³ Bylaw No. 500.13, adopted October 13, 1987

⁴ Bylaw No. 500.198, adopted May 14, 1996

PUBLIC 1 continued

Other Regulations¹

- a) For the purposes of this zone, and for the parcel legally described as Lot A, District Lot 7, Bright District, Plan 30903, *School Accommodation* means a building or buildings used for temporary lodging or dormitory units for not more than 30 people who require accommodation in conjunction with a school use.
- b) *School Accommodation* must be located within the same parcel as the school it serves, and shall not be used as a dwelling unit(s) or provide any other form of permanent or temporary accommodation, except as defined in this zone, and may not be subdivided pursuant to the ***Strata Property Act***.

¹ Bylaw No. 500.375, adopted October 23, 2012

Section 3.4.42

PUBLIC 2¹

PU2

Permitted Uses and Minimum Site Area

Required Site Area with:

Permitted Uses	Community Water & Sewer System	Community Water System	No Community Services
a) Correctional Facilities	4000 m ²	5000 m ²	8000 m ²
b) Residential Use	n/a	n/a	n/a

Maximum Number and Size of Buildings and Structures

Residential use	- 1 dwelling unit/parcel
Height	- 8.0 m
Parcel coverage	- 40%

Minimum Setback Requirements

Front lot line	- 8.0 m
Other lot lines	- 5.0 m

except where any part of a parcel is adjacent to or contains a watercourse then the regulations in Section 3.3.8 shall apply.

¹ Bylaw No. 500.179, adopted January 9, 1996

Section 3.4.43

PUBLIC 3¹

PU3

Permitted Uses and Minimum Site Area

Required Site Area with:

Permitted Uses	Community Water & Sewer System	Community Water System	No Community Services
a) Railway	n/a	n/a	n/a
b) Railway Station	n/a	n/a	n/a

Maximum Number and Size of Buildings and Structures

Height	- 10.0 m
Parcel coverage	- 10%

Minimum Setback Requirements

Front lot line	- 8.0 m
Other lot lines	- 5.0 m

except where any part of a parcel is adjacent to or contains a watercourse then the regulations in Section 3 of this Part shall apply.

¹ Bylaw No.500.283, adopted August 13, 2002

Section 3.4.44

PUBLIC 4

PU4¹

Permitted Uses and Minimum Site Area

Permitted Uses	Required Site Area with:		
	Community Water & Sewer System	Community Water System	No Community Services
a) Public Utility Use	n/a	n/a	n/a

Maximum Number and Size of Buildings and Structures

Height	- 10.0 m
Parcel coverage	- 10%

Minimum Setback Requirements

Front lot line	- 8.0 m
Other lot lines	- 5.0 m

except where any part of a parcel is adjacent to or contains a watercourse then the regulations in Section 3 of this Part shall apply.

Other Regulations²

Notwithstanding the provisions outlined above, for the parcel legally described as Lot 12, Section 14, Range 4, Mountain District, Plan VIP80079, the following shall apply:

Maximum Height	- 12.5 m
Maximum Parcel coverage	- 20%

Off-Street parking shall be permitted within the minimum setback areas

¹ Bylaw No. 500.307, adopted October 26, 2004

² Bylaw No. 500.340, adopted June 26, 2007

Section 3.4.46

PUBLIC 6¹

PU6

Permitted Uses and Minimum Site Area

Required Site Area with:

Permitted Uses	Community Water & Sewer System	Community Water System	No Community Services
a) Fish Hatchery and Associated Works	n/a	n/a	n/a
b) Flood Protection and Drainage Works	n/a	n/a	n/a
c) Park	n/a	n/a	n/a

Maximum Number and Size of Buildings and Structures

Height	- 10.0 m
Parcel coverage	- 10%

Minimum Setback Requirements

Front lot line	- 5.0 m
Other lot lines	- 5.0 m

except where any part of a parcel is adjacent to or contains a watercourse then the regulations in Section 3 of this Part shall apply.

¹ Bylaw No. 500.319, adopted July 26, 2005

Section 3.4.51

RECREATION 1

RC1

Permitted Uses and Minimum Site Area

Permitted Uses	Required Site Area with:		
	Community Water & Sewer System	Community Water System	No Community Services
a) Campground	1.0 ha	1.0 ha	2.0 ha
b) Outdoor Recreation	1.0 ha	1.0 ha	1.0 ha
c) Residential Use ¹	n/a	n/a	n/a

Maximum Number and Size of Buildings and Structures

Campground	Maximum of 60 camping spaces per parcel developed in accordance with Schedule '3C', Campground Regulations and Standards ²
Dwelling units/parcel ³	- 1
Height	- 8.0 m
Parcel coverage ⁴	- 10%

Minimum Setback Requirements

Front lot line	- 8.0 m
Other lot lines	- 5.0 m

except where any part of a parcel is adjacent to or contains a watercourse then the regulations in Section 3.3.8 shall apply.

¹ Bylaw No. 500.13, adopted October 13, 1987

² Bylaw No. 500.162, adopted April 8, 1997

³ Bylaw No. 500.13, adopted October 13, 1987

⁴ Bylaw No. 500.77, adopted march 27, 1990

Section 3.4.52

RECREATION 2¹

RC2

Permitted Uses and Minimum Site Area

Permitted Uses	Required Site Area with:		
	Community Water & Sewer System	Community Water System	No Community Services
a) Guest Accommodation	n/a	n/a	n/a
b) Outdoor Recreation	2.0 ha	2.0 ha	2.0 ha
c) Public Assembly Use	2.0 ha	2.0 ha	2.0 ha
d) Residential Use ²	n/a	n/a	n/a
e) School	n/a	n/a	n/a

Maximum Number and Size of Buildings and Structures

Dwelling units/parcel ³	- 2 ⁴
Height	- 9.0 m ⁵
Parcel coverage	- 20%
Floor area ratio	- 0.20

Minimum Setback Requirements

Front lot line	- 8.0 m
Other lot lines	- 5.0 m

except where any part of a parcel is adjacent to or contains a watercourse then the regulations in Section 3.3.8 shall apply.

¹ Bylaw No. 500.139, adopted February 9, 1993

² Bylaw No. 500.13, adopted October 13, 1987

³ Bylaw No. 500.13, adopted October 13, 1987

⁴ Bylaw No. 500.242, adopted June 13, 2000

⁵ Bylaw No. 500.242, adopted June 13, 2000

Section 3.4.53

RECREATION 3¹

RC3

Permitted Uses and Minimum Site Area

Permitted Uses	Required Site Area with:		
	Community Water & Sewer System	Community Water System	No Community Services
a) Recreational Vehicle Park ²			
b) each camping space	400 m ²	400 m ²	400 m ²
c) Residential Use	n/a	n/a	n/a

Maximum Number and Size of Buildings and Structures

Dwelling units/parcel	- 1
Height	- 8.0 m
Parcel coverage	- 10%

Minimum Setback Requirements

All lot lines	- 8.0 m
---------------	---------

except where any part of a parcel is adjacent to or contains a watercourse then the regulations in Section 3.3.8 shall apply.

¹ Bylaw No. 500.171, adopted April 11, 1995

² Bylaw No. 500.162, adopted April 8, 1997

Section 3.4.54

RECREATION 4¹

RC4

3.4.54.1 Permitted Uses

- a) Firearm Range for the use of Non-Restricted, Restricted or Prohibited Firearms as defined by the Federal **Firearm Act**.
- b) Archery Range
- c) Silviculture
- d) Residential Use

3.4.54.2 Maximum Number and Size of Buildings and Structures

- a) Accessory buildings combined floor area 1,500 m²
- b) Dwelling Units/Parcel -1
- c) Height - 8.0 m
- d) Parcel coverage - 5%

3.4.54.3 Minimum Setback Requirements

All lot lines 30.0 m;

except where any part of a parcel is adjacent to or contains a watercourse then the regulations in Section 3.3.8 shall apply.

3.4.54.4 Minimum Setback Requirements - Use

Firearm or Archery Range 30.0 m from all lot lines

¹ Bylaw No. 500.253, adopted January 11, 2000

Section 3.4.55

RECREATION 5¹

RC5

3.4.55.1 Permitted Uses

- | | |
|--|---|
| a) Alpine Recreation | vii) Kiosk for the collection of fees |
| b) No Accessory Uses or Buildings other than the following: | viii) Washrooms or Showers for a campground |
| i) Ski Lift | ix) Ski Patrol Building |
| ii) Pit Toilet | x) Warm Up Huts for use by ski patrol |
| iii) Board Walk, Stairs, Pedestrian Bridge | xi) Ski Lodge |
| iv) Medical Evacuation Helipad | xii) Tourist Store |
| v) Maintenance Facility | xiii) Inn |
| vi) Off-Street Parking and Loading for a ski resort in accordance with Schedule '3' B, Off-Street Parking and Loading Spaces | xiv) Restaurant |
| | xv) Campground |
-

3.4.55.2 Maximum Number and Size of Buildings Structures and Uses

- a) Maintenance Facility:
The combined total floor area of all maintenance buildings must not exceed 2,000 m².
- b) Ski Patrol Building and Warm Up Huts:
The combined total floor area of all ski patrol buildings and warm up huts must not exceed 300 m².
- c) Accommodation:
- i) The combined total number of hotel units and camping spaces must not exceed 50.
 - ii) For the purpose of Section 3.4.55.2 (c)(i), from May 1 to October 31 inclusive, not more than 50 camping spaces may be available for occupancy in lieu of constructed hotel units which shall be unavailable for occupancy and shall not be used between May 1 and October 31.
 - iii) No camping space referred to in Section 3.4.55.2(c)(ii) may exceed 150 m² in area and the camping spaces must be located adjacent to one another in a maximum of two groupings.
 - iv) The combined total floor area utilized for hotel units shall not exceed the product of the following calculation: number of hotel units X 50 m² of hotel unit floor area
- d) Ski Lodge:
- i) A maximum of 2 ski lodge buildings will be permitted.
 - ii) The combined total floor area of all ski lodge buildings excluding hotel units and access corridors to hotel units, must not exceed 3,000 m².
- e) Tourist Store:
- i) The combined total floor area of all tourist stores within ski lodges must not exceed 200 m².
 - iii) The combined total floor area of all tourist stores not within a ski lodge must not exceed 200 m²

¹ Bylaw No. 500.253, adopted January 11, 2000

RECREATION 5 continued

- f) Restaurant:
 - i) The combined total floor area of all restaurants within ski lodges must not exceed 400 m².
 - ii) The combined total floor area of all restaurants not within a ski lodge must not exceed 400 m².
 - g) Height
16.0 m however, this maximum may be exceeded for ski lifts
-

3.4.55.3 Minimum Parcel Area

Subject to Section 4.4.4, no parcel having an area less than the applicable subdivision district as stated in Section 4.1 may be created by subdivision, and for the purposes of this subsection, "parcel" includes a lot created by deposit of a strata plan under the **Strata Property Act** (British Columbia).

3.4.55.4 Minimum Setback Requirements

All lot lines - 5.0 m;

except where any part of a parcel is adjacent to or contains a watercourse then the regulations in Section 3.3.8 shall apply.

3.4.55.5 Other Regulations

- a) Mountain bike trails must have a permeable surface.
- b) Recreational vehicles in campgrounds must not exceed 37 m² in floor area.
- c) Camping spaces must be developed in accordance with Schedule '3C', Campground Regulations and Standards.
- d) For the purposes of this zone, "temporary accommodation" means occupancy of a ski lodge, inn or campground by an individual, other than Mount Arrowsmith staff occupying a hotel unit, for fewer than 4 consecutive weeks in a calendar year and fewer than 120 days in total during the same calendar year.
- e) In the event of inconsistency between any provision of Section 3.4.55 and any other provision of this Bylaw, the Section 3.4.55 provision will apply and the other provision will not apply to the extent of the inconsistency.

Section 3.4.56

RECREATION 6¹

RC6

3.4.56.1 Permitted Uses

- a) Motocross Track
- b) Campground
- c) Residential Use

3.4.56.2 Maximum Number and Size of Buildings and Structures

- a) Campground 50 camping spaces
- b) Accessory buildings other than spectator seating combined floor area 200 m²
- c) Dwelling Units/Parcel -1
- d) Height - 8.0 m
- e) Parcel coverage - 5%

3.4.56.3 Minimum Parcel Area

Subject to Section 4.4.4, no parcel having an area less than the applicable subdivision district as stated in Section 4.1 may be created by subdivision, and for the purposes of this subsection, "parcel" includes a lot created by deposit of a strata plan under the **Strata Property Act** (British Columbia).

3.4.56.4 Minimum Setback Requirements

All lot lines 30.0 m;
except where any part of a parcel is adjacent to or contains a watercourse then the regulations in Section 3.3.8 shall apply.

3.4.56.5 Minimum Setback Requirements - Use

Motorcross Track 30.0 m from all lot lines

3.4.56.6 Other Regulations

- a) Recreational vehicles in campgrounds must not exceed 37 m² in floor area.
- b) Camping spaces must be developed in accordance with Schedule '3C', Campground Regulations and Standards.
- c) In the event of inconsistency between the following provision of Section 3.4.56 on maximum occupancy within a campground and any other provision of this Bylaw, the following provision will apply and the other provision will not apply to the extent of the inconsistency: the maximum occupancy for an individual within a campground is less than 3 consecutive days in a calendar year and less than 30 days in the same calendar year.

¹ Bylaw No. 500, adopted January 11, 2000

Section 3.4.61

RESIDENTIAL 1

RS1

Permitted Uses and Minimum Site Area

Required Site Area with:

Permitted Uses	Community Water & Sewer System	Community Water System	No Community Services
a) Home Based Business ¹	n/a	n/a	n/a
b) Residential Use	n/a	n/a	n/a
c) Secondary Suite ²	n/a	n/a	n/a

Maximum Number and Size of Buildings and Structures

Accessory buildings	- combined floor area of 100 m ² or 8% of area of parcel whichever is greater, but shall not exceed 250 m ² . ³
Accessory building height ⁴	- 6.0 m
Dwelling units/parcel ⁵	- 1
Dwelling unit height ⁶	- 8.0 m
Parcel coverage ⁷	- 35%

Minimum Setback Requirements

Front lot line	- 8.0 m
Interior side lot line	- 2.0 m
Rear lot line ⁸	- 2.0 m
Other lot lines	- 5.0 m

except where any part of a parcel is adjacent to or contains a watercourse then the regulations in Section 3.3.8 shall apply.

No setback from an interior or rear lot line shall be required for one accessory building not exceeding a floor area of 10 m² and with a maximum height of 3.0 metres.⁹

¹ Bylaw No. 500.270, adopted November 13, 2001

² Bylaw No. 500.389, adopted May 27, 2014

³ Bylaw No. 500.272, adopted November 13, 2001

⁴ Bylaw No. 500.113, adopted August 13, 1991

⁵ Bylaw No. 500.13, adopted October 13, 1987

⁶ Bylaw No. 500.113, adopted August 13, 1991

⁷ Bylaw No. 500.13, adopted October 13, 1987

⁸ Bylaw No. 500.17, adopted February 14, 1989

⁹ Bylaw No. 500.17, adopted February 14, 1989

Section 3.4.62

RESIDENTIAL 1.1¹

RS1.1

Permitted Uses and Minimum Site Area

Required Site Area with:

Permitted Uses	Community Water & Sewer System	Community Water System	No Community Services
a) Home Based Business	n/a	n/a	n/a
b) Residential Use	n/a	n/a	n/a
c) Secondary Suite ²			

Maximum Number and Size of Buildings and Structures

Accessory buildings	- combined floor area of 100 m ² or 8% of area of parcel whichever is greater, but shall not exceed 250 m ² .
Accessory building height	- 6.0 m
Dwelling units/parcel	- 1
Dwelling unit height	- 10.0 m
Parcel coverage ³	- 35%

Minimum Setback Requirements

Front lot line	- 5.0 m
Exterior side lot line	- 5.0 m
Other lot lines	- 2.0 m

except where any part of a parcel is adjacent to or contains a watercourse then the regulations in Section 3.3.8 shall apply.

No setback from an interior or rear lot line shall be required for one accessory building not exceeding a floor area of 10 m² and with a maximum height of 3.0 metres.

¹ Bylaw No. 500.361, adopted January 25, 2011

² Bylaw No. 500.389, adopted May 27, 2014

Section 3.4.61.3

RESIDENTIAL 1.2¹

RS1.2

Permitted Uses and Minimum Site Area

Permitted Uses

- a) Home Based Business
- b) Residential Use
- c) Secondary Suite

Maximum Number and Size of Buildings and Structures

Accessory buildings	Combined floor area of 100 m ² or 8% of area of parcel whichever is greater, but shall not exceed 250 m ² .
Accessory building height	6.0 m
Dwelling units/parcel	1
Dwelling unit height	8.0 m
Parcel coverage	45%

Minimum Setback Requirements

Front lot line	5.0 m 6.0 m to any garage door or carport entrance way facing a highway
Interior side lot line	1.5 m
Rear lot line	2.0 m
Other lot lines	5.0 m

Except where any part of a parcel is adjacent to or contains a watercourse then the regulations in Section 3.3.8 shall apply.

No setback from an interior or rear lot line shall be required for one accessory building not exceeding a floor area of 10 m² and with a maximum height of 3.0 metres.

¹ Bylaw No. 500.394, adopted August 25, 2015

Section 3.4.62

RESIDENTIAL 2**RS2****Permitted Uses and Minimum Site Area**

Permitted Uses	Required Site Area with:		
	Community Water & Sewer System	Community Water System	No Community Services
a) Home Based Business ¹	n/a	n/a	n/a
b) Residential Use - per dwelling unit ²	2000 m ²	2000 m ²	1.0 ha
c) Secondary Suite ³	n/a	n/a	n/a

Maximum Number and Size of Buildings and Structures

Accessory buildings ⁴	- combined floor area of 100 m ² or 10% of area of parcel whichever is greater, but shall not exceed 250 m ² . ⁵
Accessory building height	- 6.0 m
Dwelling units/parcel	- 2
Dwelling unit height	- 8.0 m
Parcel coverage ⁶	- 35%

Minimum Setback Requirements

Front lot line	- 8.0 m
Interior side lot line	- 2.0 m
Rear lot line ⁷	- 2.0 m
Other lot lines	- 5.0 m

except where any part of a parcel is adjacent to or contains a watercourse then the regulations in Section 3.3.8 shall apply.

No setback from an interior or rear lot line shall be required for one accessory building not exceeding a floor area of 10 m² and with a maximum height of 3.0 m.⁸

¹ Bylaw No. 500.270, adopted November 13, 2001

² Bylaw No. 500.13, adopted October 13, 1987

³ Bylaw No. 500.389, adopted May 27, 2014

⁴ Bylaw No. 500.193, adopted January 9, 1996

⁵ Bylaw No. 500.272, adopted November 13, 2001

⁶ Bylaw No. 500.13, adopted October 13, 1987

⁷ Bylaw No. 500.17, adopted February 14, 1989

⁸ Bylaw No. 500.17, adopted February 14, 1989

Section 3.4.62.1

RESIDENTIAL 2.1¹

RS2.1

Permitted Uses and Minimum Site Area

Required Site Area with:

Permitted Uses	Community Water & Sewer System	No Community Services
a) Home Based Business	n/a	n/a
b) Residential Use - per dwelling unit	1400 m ²	1.0 ha

Maximum Number and Size of Buildings and Structures

Accessory buildings	- combined floor area of 100 m ² or 8% of area of parcel whichever is greater, but shall not exceed 250 m ² .
Accessory building height	- 6.0 m
Dwelling units/parcel	- 1 duplex
Dwelling unit height	- 8.0 m
Parcel coverage	- 35%

Minimum Setback Requirements

Front lot line	- 8.0 m
Interior side lot line	- 2.0 m
Rear lot line	- 2.0 m
Other lot lines	- 5.0 m

except where:

any part of a parcel is adjacent to or contains a watercourse then the regulations in Section 3.3. shall apply.

Other Regulations

No setback from an interior or rear lot line shall be required for one accessory building not exceeding a floor area of 10 m² and with a maximum height of 3.0 m.

¹ Bylaw No. 500.293, adopted August 12, 2003

Section 3.4.62.2

RESIDENTIAL 2.2¹

RS2.2

Permitted Uses and Minimum Site Area

Required Site Area with:

Permitted Uses	Community Water & Sewer System	Community Water System	No Community Services
a) Home Based Business	n/a	n/a	n/a
b) Residential Use - per dwelling unit	500 m ²	1000 m ²	1.0 ha
c) Duplex	1000 m ²	2000 m ²	2.0 ha

Maximum Number and Size of Buildings and Structures

Floor area ratio	- 0.60
Height	- 8.0 m
Parcel coverage	- 40%

Minimum Setback Requirements

Front lot line	- 8.0 m
Interior side lot line	- 1.5 m
Rear lot line	- 2.0 m
Other lot line	- 5.0 m

except where:

- a) an accessory building for individual use is permitted, no setback from an interior lot line shall be required for one accessory building with a maximum height of 2.0 m and a floor area of 9.0 m²;
- b) any part of a parcel is adjacent to or contains a watercourse then the regulations in Section 3.3.8 shall apply.

¹ Bylaw No. 500.395, adopted September 29, 2015

Section 3.4.63

RESIDENTIAL 3

RS3

Permitted Uses and Minimum Site Area

Permitted Uses	Required Site Area with:		
	Community Water & Sewer System	Community Water System	No Community Services
a) Residential Use - per dwelling unit	2000 m ²	2000 m ²	1.0 ha
b) Multiple Dwelling Unit Development: - per dwelling unit	2000 m ²	2000 m ²	1.0 ha
c) Home Based Business ¹	n/a	n/a	n/a

Maximum Number and Size of Buildings and Structures

Accessory buildings	- combined floor area of 100 m ² or 8% of area of parcel whichever is greater, but shall not exceed 250 m ² . ²
Height	- 8.0 m
Parcel coverage ³	- 35%

Minimum Setback Requirements

1. In a Multiple Dwelling Unit development or on a parcel divided pursuant to the **Strata Property Act** and not contained within a Bare Land Strata Plan:
 - All lot lines - 10.0 m;
2. All other buildings and structures:
 - Front and exterior lot lines - 8.0 m
 - Other lot lines - 3.0 m

except where:

- a) an accessory building for individual use is permitted, no setback from an interior lot line shall be required for one accessory building with a maximum
- b) height of 2.0 m and a floor area of 9.0 m²;
- c) any part of a parcel is adjacent to or contains a watercourse then the regulations in Section 3.3.8 shall apply.

¹ Bylaw No. 500.270, adopted November 13, 2001

² Bylaw No. 500.272, adopted November 13, 2001

³ Bylaw No. 500.13, adopted October 13, 1987

Section 3.4.64

RESIDENTIAL 4

RS4

Permitted Uses and Minimum Site Area

Required Site Area with:

Permitted Uses	Community Water & Sewer System	Community Water System	No Community Services
d) Multiple Dwelling Unit Development: - per dwelling unit	700 m ²	1600 m ²	1.0 ha

Maximum Number and Size of Buildings and Structures

Floor area ratio	- 0.50
Height	- 8.0 m
Parcel coverage	- 50%

Minimum Setback Requirements

1. In a Multiple Dwelling Unit development or on a parcel divided pursuant to the **Strata Property Act** and not contained within a Bare Land Strata Plan:
 - All lot lines - 10.0 m;
2. All other buildings and structures:
 - Front and exterior lot lines - 8.0 m
 - Other lot lines - 3.0 m
 except where:
 - a) an accessory building for individual use is permitted, no setback from an interior lot line shall be required for one accessory building with a maximum height of 2.0 m and a floor area of 9.0 m²;
 - b) any part of a parcel is adjacent to or contains a watercourse then the regulations in Section 3.3.8 shall apply.

Section 3.4.65

RESIDENTIAL 5

RS5

Permitted Uses and Minimum Site Area

Permitted Uses	Required Site Area with:		
	Community Water & Sewer System	Community Water System	No Community Services
a) Multiple Dwelling Unit Development: - per dwelling unit	500 m ²	1600 m ²	1.0 ha

Maximum Number and Size of Buildings and Structures

Floor area ratio	- 0.60
Height	- 8.0 m
Parcel coverage	- 60%

Minimum Setback Requirements

1. In a Multiple Dwelling Unit development or on a parcel divided pursuant to the **Strata Property Act** and not contained within a Bare Land Strata Plan:
All lot lines - 10.0 m;
2. All other buildings and structures:
Front and exterior lot lines - 8.0 m
Other lot lines - 3.0 m

except where any part of a parcel is adjacent to or contains a watercourse then the regulations in Section 3.3.8 shall apply.

Section 3.4.66

RESIDENTIAL 6

RS6

Permitted Uses and Minimum Site Area

Required Site Area with:

Permitted Uses	Community Water & Sewer System	Community Water System	No Community Services
a) Mobile Home Park	2.0 ha	2.0 ha	3.0 ha
- per mobile home	500 m ²	2000 m ²	1.0 ha

Maximum Number and Size of Buildings and Structures

Height	8.0 m
Mobile homes	subject to servicing requirements (a) above and developed in accordance with Schedule '3D'
Parcel coverage	40%

Minimum Setback Requirements

Front lot line	- 8.0 m
Other lot lines	- 5.0 m

except where any part of a parcel is adjacent to or contains a watercourse then the regulations in Section 3.3.8 shall apply.

Section 3.4.67

RESIDENTIAL 7

RS7

Permitted Uses and Minimum Site Area

Permitted Uses	Required Site Area with:		
	Community Water & Sewer System	Community Water System	No Community Services
a) Mobile Home Park - per mobile home	2.0 ha 1000 m ²	2.0 ha 1000 m ²	3.0 ha 4000 m ²

Maximum Number and Size of Buildings and Structures

Height	8.0 m
Mobile homes	subject to servicing requirements (a) above and developed in accordance with Schedule '3D'
Parcel coverage	40%

Minimum Setback Requirements

Front lot line	- 8.0 m
Other lot lines	- 5.0 m

except where any part of a parcel is adjacent to or contains a watercourse then the regulations in Section 3.3.8 shall apply.

Section 3.4.68

RESIDENTIAL 8¹

RS8

Permitted Uses and Minimum Site Area

Permitted Uses	Required Site Area with:		
	Community Water & Sewer System	Community Water System	No Community Services
a) Multiple Dwelling Unit Development: - per dwelling unit	310 m ²	1600 m ²	1.0 ha

Maximum Number and Size of Buildings and Structures

Floor area ratio	- 0.75
Height	- 15.0 m
Parcel coverage	- 60%

Minimum Setback Requirements

1. In a Multiple Dwelling Unit development or on a parcel divided pursuant to the **Strata Property Act** and not contained within a Bare Land Strata Plan:
All lot lines - 10.0 m
2. All other buildings and structures:
Front and exterior lot lines - 8.0 m
Other lot lines - 3.0 m

except where any part of a parcel is adjacent to or contains a watercourse then the regulations in Section 3.3.8 shall apply.

¹ Bylaw No. 500.15, adopted September 8, 1987

Section 3.4.71

RESOURCE MANAGEMENT 1**RM1****Permitted Uses and Minimum Site Area**

Required Site Area with:

Permitted Uses	Community Water & Sewer System	Community Water System	No Community Services
a) Agriculture	n/a	n/a	n/a
b) Aquaculture	5000 m ²	5000 m ²	5000 m ²
c) Extraction Use	2.0 ha	2.0 ha	2.0 ha
d) Home Based Business ¹	n/a	n/a	n/a
e) Log Storage & Sorting Yard	1.0 ha	1.0 ha	1.0 ha
f) Primary Processing	5.0 ha	5.0 ha	5.0 ha
g) Residential Use ²	n/a	n/a	n/a
h) Silviculture	n/a	n/a	n/a

3 4

Maximum Number and Size of Buildings and Structures⁵

1) Accessory buildings	combined floor area of 400m ²
2) Dwelling Units/parcel:	
a) on a parcel having an area of 8.0 ha or less	1
<i>For Electoral Areas 'A,C,E and H'</i>	
b) on a parcel having an area greater than 8.0 ha	2
<i>For Electoral Area 'G'</i>	
c) on a parcel having an area equal to or greater than twice the minimum parcel size as established by Schedule '4B' Subdivision District – Minimum Parcel Sizes'	2
d) Notwithstanding subsection (c), on a parcel located in this zone and created prior to February 22, 2011 and having an area greater than 8.0 ha	2
3) Height	9.0m
4) Parcel Coverage	10%

¹ Bylaw No. 500.270, adopted November 13, 2001² Bylaw No. 500.13, adopted October 13, 1987³ Bylaw No. 500.166, adopted April 11, 1995 (Asphalt Batch Plant deleted)⁴ Bylaw No. 500.162, adopted April 8, 1997 (Campground deleted)⁵ Bylaw No. 500.359, adopted January 25, 2011

RESOURCE MANAGEMENT 1 continued

Minimum Setback Requirements

1. All agriculture or farm buildings, structures and uses – in accordance with Section 3.3.10.¹
2. All other buildings and structures

All lot lines - 20.0 m

except where any part of a parcel is adjacent to or contains a watercourse then the regulations in Section 3.3.8 shall apply.

¹ Bylaw No. 500.402, adopted June 28, 2016

Section 3.4.72

RESOURCE MANAGEMENT 2¹**RM2****Permitted Uses and Minimum Site Area**

Required Site Area with:

Permitted Uses	Community Water & Sewer System	Community Water System	No Community Services
a) Agriculture	n/a	n/a	n/a
b) Aquaculture	5000 m ²	5000 m ²	5000 m ²
c) Asphalt Batch Plant	2.0 ha	2.0 ha	2.0 ha
d) Extraction Use	2.0 ha	2.0 ha	2.0 ha
e) Home Based Business ²	n/a	n/a	n/a
f) Log Storage & Sorting Yard	1.0 ha	1.0 ha	1.0 ha
g) Primary Processing	5.0 ha	5.0 ha	5.0 ha
h) Residential Use	n/a	n/a	n/a
i) Silviculture	n/a	n/a	n/a
j) Wood Waste Facility for the parcel legally described as Lot A, Section 19, Range 1, Mountain District, Plan VIP76600 ³	n/a	n/a	n/a

Maximum Number and Size of Buildings and Structures

Dwelling units/parcel:

- a) on a parcel having an area of 8.0 ha or less - 1
- b) on a parcel having an area greater than 8.0 ha - 2

Accessory buildings	- combined floor area of 400 m ² ⁴
Height	9.0 m ⁵
Parcel coverage	10%

Minimum Setback Requirements

1. All agriculture or farm buildings, structures and uses – in accordance with Section 3.3.10⁶
2. All other buildings and structures

All lot lines - 20.0 m

except where any part of a parcel is adjacent to or contains a watercourse then the regulations in Section 3.3.8 shall apply.

¹ Bylaw No. 500.166, adopted April 11, 1995 (Introduces RM2)

² Bylaw No. 500.270, adopted November 13, 2001

³ Bylaw No. 500.354, adopted February 23, 2010

⁴ Bylaw No. 500.272, adopted November 13, 2001

⁵ Bylaw No. 500.246, adopted December 8, 1998

⁶ Bylaw No. 500.402, adopted June 28, 2016

Section 3.4.73

RESOURCE MANAGEMENT 3¹

RM3

Permitted Uses and Minimum Site Area

Required Site Area with:

Permitted Uses	Community Water & Sewer System	Community Water System	No Community Services
a) Agriculture	n/a	n/a	n/a
b) Aquaculture	5000 m ²	5000 m ²	5000 m ²
c) Extraction Use	2.0 ha	2.0 ha	2.0 ha
d) Home Based Business ²	n/a	n/a	n/a
e) Log Storage & Sorting Yard	1.0 ha	1.0 ha	1.0 ha
f) Primary Processing	5.0 ha	5.0 ha	5.0 ha
g) Residential Use	n/a	n/a	n/a
h) Silviculture	n/a	n/a	n/a

Maximum Number and Size of Buildings and Structures

Dwelling units/parcel:

- a) on a parcel having an area of 8.0 ha or less - 1
 - b) on a parcel having an area greater than 8.0 ha - 2
- Accessory buildings - combined floor area of 400 m²³
- Height 9.0 m⁴
- Parcel coverage 10%

Minimum Setback Requirements

1. All agriculture or farm buildings, structures and uses – in accordance with Section 3.3.10
2. All other buildings and structures
 - All lot lines - 20.0 m

except where any part of a parcel is adjacent to or contains a watercourse then the regulations in Section 3.3.8 shall apply.

¹ Bylaw No. 500.218, adopted August 12, 1997 (Introduces RM3)

² Bylaw No. 500.270, adopted November 13, 2001

³ Bylaw No. 500.272, adopted November 13, 2001

⁴ Bylaw No. 500.246, adopted December 8, 1998

Section 3.4.74

RESOURCE MANAGEMENT 4¹**RM4****3.4.74.1 Permitted Uses and Minimum Site Area**

Required Site Area with:

Permitted Uses	Community Water & Sewer System	Community Water System	No Community Services
a) Agriculture	n/a	n/a	n/a
b) Aquaculture	5000 m ²	5000 m ²	5000 m ²
c) Extraction Use	2.0 ha	2.0 ha	2.0 ha
d) Home Based Business ²	n/a	n/a	n/a
e) Log Storage & Sorting Yard	1.0 ha	1.0 ha	1.0 ha
f) Primary Processing	5.0 ha	5.0 ha	5.0 ha
g) Residential Use	n/a	n/a	n/a
h) Silviculture	n/a	n/a	n/a

3.4.74.2 Maximum Number and Size of Buildings and Structures

- | | |
|--------------------------|--|
| a) Dwelling units/parcel | - 1 |
| b) Accessory buildings | - combined floor area of 400 m ² ³ |
| c) Height | 9.0 m |
| d) Parcel coverage | 10% |

3.4.74.3 Minimum Setback Requirements

- a) All agriculture or farm buildings, structures and uses – in accordance with Section 3.3.10⁴
- b) All other buildings and structures
- All lot lines - 20.0 m

except where any part of a parcel is adjacent to or contains a watercourse then the regulations in Section 3.3.8 shall apply.

¹ Bylaw No. 500.253, adopted January 11, 2000

² Bylaw No. 500.270, adopted November 13, 2001

³ Bylaw No. 500.272, adopted November 13, 2001

⁴ Bylaw No. 500.402, adopted June 28, 2016

Section 3.4.75

RESOURCE MANAGEMENT 5¹**RM5****3.4.75.1 Permitted Uses and Minimum Site Area**

Required Site Area with:

Permitted Uses	Community Water & Sewer System	Community Water System	No Community Services
c) Agriculture	n/a	n/a	n/a
d) Aquaculture	5000 m ²	5000 m ²	5000 m ²
e) Extraction Use	2.0 ha	2.0 ha	2.0 ha
f) Home Based Business ²	n/a	n/a	n/a
g) Log Storage & Sorting Yard	1.0 ha	1.0 ha	1.0 ha
h) Primary Processing	5.0 ha	5.0 ha	5.0 ha
i) Residential Use	n/a	n/a	n/a
j) Silviculture	n/a	n/a	n/a

3.4.75.2 Maximum Number and Size of Buildings and Structures

- a) Dwelling units/parcel:
- i) on a parcel having an area 8.0 ha or less -1
 - ii) on a parcel having an area greater than 8.0 ha -2
- b) Accessory buildings - combined floor area of 400 m² ³
- c) Height 9.0 m
- d) Parcel coverage 10%

3.4.75.3 Minimum Parcel Area

Subject to Section 4.4.4, no parcel having an area less than the applicable subdivision district as stated in Section 4.1 may be created by subdivision, and for the purposes of this subsection, "parcel" includes a lot created by deposit of a strata plan under the **Strata Property Act** (British Columbia) but excludes a bare land strata lot.

3.4.75.4 Minimum Setback Requirements

- a) All agriculture or farm buildings, structures and uses – in accordance with Section 3.3.10⁴
- b) All other buildings and structures

All lot lines - 20.0 m

except where any part of a parcel is adjacent to or contains a watercourse then the regulations in Section 3.3.8 shall apply.

¹ Bylaw No. 500.253, adopted January 11, 2000

² Bylaw No. 500.270, adopted November 13, 2001

³ Bylaw No. 500.272, adopted November 13, 2001

⁴ Bylaw No. 500.402, adopted June 28, 2016

Section 3.4.76

RESOURCE MANAGEMENT 6¹

RM6

3.4.76.1 Permitted Uses and Minimum Site Area

Required Site Area with:

Permitted Uses	Community Water & Sewer System	Community Water System	No Community Services
a) Extraction Use	2.0 ha	2.0 ha	2.0 ha
b) Primary Processing	5.0 ha	5.0 ha	5.0 ha
c) Residential Use	n/a	n/a	n/a
d) Wood Waste Disposal Facility	n/a	n/a	n/a

3.4.76.2 Maximum Number and Size of Buildings and Structures

- a) Dwelling units/parcel - 1
 - b) Accessory buildings - combined floor area of 400 m² ²
 - c) Height - 7.8 m
 - d) Parcel coverage - 5%
-

3.4.76.3 Minimum Setback Requirements

All lot lines - 7.5 m

except where any part of a parcel is adjacent to or contains a watercourse then the regulations in Section 3.3.8 shall apply.

¹ Bylaw No.500.253, adopted January 11, 2000

² Bylaw No.500.272, adopted November 13, 2001

Section 3.4.77

RESOURCE MANAGEMENT 7¹

RM7

3.4.77.1 Permitted Uses and Minimum Site Area

Required Site Area with:

Permitted Uses	Community Water & Sewer System	Community Water System	No Community Services
a) Agriculture	n/a	n/a	n/a
b) Aquaculture	5000 m ²	5000 m ²	5000 m ²
c) Asphalt Batch Plant	2.0 ha	2.0 ha	2.0 ha
d) Extraction Use	2.0 ha	2.0 ha	2.0 ha
e) Home Based Business ²	n/a	n/a	n/a
f) Log Storage & Sorting Yard	1.0 ha	1.0 ha	1.0 ha
g) Primary Processing	5.0 ha	5.0 ha	5.0 ha
h) Residential Use	n/a	n/a	n/a
i) Silviculture	n/a	n/a	n/a

3.4.77.2 Maximum Number and Size of Buildings and Structures

- a) Dwelling units/parcel:
 - i) on a parcel having an area of 8.0 ha or less - 1
 - ii) on a parcel having an area greater than 8.0 ha - 2
- b) Despite Section 3.4.77.2 a) ii), the permitted density of one of the parcels located within an eligible subdivision shall be two dwelling units provided the parcel is greater than 8.0 ha.
- c) After the development of 2 dwelling units on the parcel referred to in Section 3.4.77.2 (b), the maximum permitted density of all other parcels located within the eligible subdivision shall be 1 dwelling unit per parcel.
- d) Accessory buildings -combined floor area of 400 m² ³
- e) Height 9.0 m
- f) Parcel coverage 10%

3.4.77.3 Minimum Parcel Area

Subject to Section 4.4.4, no parcel having an area less than the applicable subdivision district as stated in Section 4.1 may be created by subdivision, and for the purposes of this subsection, "parcel" includes a lot created by deposit of a strata plan under the **Strata Property Act** (British Columbia) but excludes a bare land strata lot.

¹ Bylaw No.500.253, adopted January 11, 2000
² Bylaw No.500.270, adopted November 13, 2001
³ Bylaw No.500.272, adopted November 13, 2001

RESOURCE MANAGEMENT 7 continued

3.4.77.4 Minimum Setback Requirements

- a) All agriculture or farm buildings, structures and uses – in accordance with Section 3.3.10¹
- b) All other buildings and structures
All lot lines - 20.0 m

except where any part of a parcel is adjacent to or contains a watercourse then the regulations in Section 3.3.8 shall apply.

¹ Bylaw No. 500.402, adopted June 28, 2016

Section 3.4.78

RESOURCE MANAGEMENT 8¹

RM8

3.4.78.1 Permitted Uses and Minimum Site Area

Required Site Area with:

Permitted Uses	Community Water & Sewer System	Community Water System	No Community Services
a) Agriculture	n/a	n/a	n/a
b) Aquaculture	5000 m ²	5000 m ²	5000 m ²
c) Extraction Use	2.0 ha	2.0 ha	2.0 ha
d) Home Based Business ²	n/a	n/a	n/a
e) Log Storage & Sorting Yard	1.0 ha	1.0 ha	1.0 ha
f) Primary Processing	5.0 ha	5.0 ha	5.0 ha
g) Residential Use	n/a	n/a	n/a
h) Silviculture	n/a	n/a	n/a
i) Wood Processing	2.0 ha	2.0 ha	2.0 ha

3.4.78.2 Maximum Number and Size of Buildings and Structures

- a) Dwelling units/parcel:
 - i) on a parcel having an area of 8.0 ha or less - 1
 - ii) on a parcel having an area greater than 8.0 ha - 2
- b) Accessory buildings - combined floor area of 400 m²³
- c) Height 9.0 m
- d) Parcel coverage 10%

3.4.78.3 Minimum Setback Requirements

- a) All agriculture or farm buildings, structures and uses – in accordance with Section 3.3.10⁴
- b) All other buildings and structures
All lot lines - 7.5 m

except where any part of a parcel is adjacent to or contains a watercourse then the regulations in Section 3.3.8 shall apply.

¹ Bylaw No. 500.253, adopted January 11, 2000
² Bylaw No. 500.270, adopted November 13, 2001
³ Bylaw No. 500.272, adopted November 13, 2001
⁴ Bylaw No. 500.402, adopted June 28, 2016

Section 3.4.79

RESOURCE MANAGEMENT 9¹**RM9****3.4.79.1 Permitted Uses and Minimum Site Area**

Required Site Area with:

Permitted Uses	Community Water & Sewer System	Community Water System	No Community Services
a) Agriculture	n/a	n/a	n/a
b) Aquaculture	5000 m ²	5000 m ²	5000 m ²
c) Extraction Use	2.0 ha	2.0 ha	2.0 ha
d) Home Based Business ²	n/a	n/a	n/a
e) Log Storage & Sorting Yard	1.0 ha	1.0 ha	1.0 ha
f) Primary Processing	5.0 ha	5.0 ha	5.0 ha
g) Residential Use	n/a	n/a	n/a
h) Silviculture	n/a	n/a	n/a

3.4.79.2 Maximum Number and Size of Buildings and Structures

- a) Dwelling units/parcel:
- (i) on a parcel having an area 8.0 ha or less -1
 - (ii) on a parcel having an area greater than 8.0 ha -2
- b) Despite Section 3.4.79.2 (a) (ii), the maximum permitted density of one of the parcels located within an eligible subdivision shall be two dwelling units provided the parcel is greater than 8.0 hectares.
- c) After the development of 2 dwelling units on the parcel referred to in Section 3.4.79.2 (b), the maximum permitted density of all other parcels located within the eligible subdivision shall be 1 dwelling unit per parcel.
- d) Accessory buildings -combined floor area of 400 m² ³
- e) Height 9.0 m
- f) Parcel coverage 10%

3.4.79.3 Minimum Parcel Area

Subject to Section 4.4.4, no parcel having an area less than the applicable subdivision district as stated in Section 4.1 may be created by subdivision, and for the purposes of this subsection, "parcel" includes a lot created by deposit of a strata plan under the **Strata Property Act** (British Columbia) but excludes a bare land strata lot.

¹ Bylaw No. 500.253, adopted January 11, 2000

² Bylaw No. 500.270, adopted November 13, 2001

³ Bylaw No. 500.272, adopted November 13, 2001

RESOURCE MANAGEMENT 9 continued

3.4.79.4 Minimum Setback Requirements

- a) All agriculture or farm buildings, structures and uses – in accordance with Section 3.3.10¹
- b) All other buildings and structures
 - All lot lines - 20.0 m

except where any part of a parcel is adjacent to or contains a watercourse then the regulations in Section 3.3.8 shall apply.

¹ Bylaw No. 500.402, adopted June 28, 2016

Section 3.4.81

RURAL 1

RU1

Permitted Uses and Minimum Site Area

Required Site Area with:

Permitted Uses	Community Water & Sewer System	Community Water System	No Community Services
a) Agriculture	n/a	n/a	n/a
b) Aquaculture	5000 m ²	5000 m ²	5000 m ²
c) Home Based Business ¹	n/a	n/a	n/a
d) Produce Stand	n/a	n/a	n/a
e) Residential Use	n/a	n/a	n/a
f) Silviculture	n/a	n/a	n/a
g) Secondary Suite ²	n/a	n/a	n/a

Maximum Number and Size of Buildings and Structures³

1) Accessory buildings	combined floor area of 400m ²
2) Dwelling Units/parcel:	
a) on a parcel having an area of 2.0 ha or less	1
For Electoral Areas 'A,C,E and H'	
b) on a parcel having an area greater than 2.0 ha	2
For Electoral Area 'G'	
c) on a parcel having an area equal to or greater than twice the minimum parcel size as established by Schedule '4B Subdivision District –Minimum Parcel Sizes'	2
d) Notwithstanding subsection (c), on a parcel located in this zone and created prior to February 22, 2011 and having an area greater than 2.0 ha	2
3) Height	9.0m
4) Parcel Coverage	25%

¹ Bylaw No. 500.270, adopted November 13, 2001

² Bylaw No. 500.389, adopted May 27, 2014

³ Bylaw No. 500.359, adopted January 25, 2011

R U R A L 1 continued

Minimum Setback Requirements

1. All agriculture or farm buildings, structures and uses – in accordance with Section 3.3.10¹
2. All other buildings and structures
All lot lines - 8.0 m

except where:

- a) the parcel is less than 4000 m² in area then the setback from lot lines may be reduced to 2.0 m from an interior side lot line and to 5.0 m from other lot lines, excluding the front lot line;²
- b) any part of a parcel is adjacent to or contains a watercourse then the regulations in Section 3.3.8 shall apply.³

¹ Bylaw No. 500.402, adopted June 28, 2016

² Bylaw No.500.13, adopted October 13, 1987

³ Bylaw No.500.13, adopted October 13, 1987

Section 3.4.81.1¹

R U R A L 1.1

RU1.1

Permitted Uses and Minimum Site Area

Required Site Area with:

Permitted Uses	Community Water & Sewer System	Community Water System	No Community Services
a) Agriculture	n/a	n/a	n/a
b) Aquaculture	5000 m ²	5000 m ²	5000 m ²
c) Home Based Business	n/a	n/a	n/a
d) Produce Stand	n/a	n/a	n/a
e) Residential Use	n/a	n/a	n/a
f) Silviculture	n/a	n/a	n/a
g) Secondary Suite	n/a	n/a	n/a

Maximum Number and Size of Buildings and Structures

1) Accessory buildings	combined floor area of 400m ²
2) Dwelling Units/parcel:	
a) on a parcel having an area greater than twice the minimum parcel size as established by Schedule '4B Subdivision District – Minimum Parcel Sizes'	2
b) on a parcel having an area equal to or less than twice the minimum parcel size as established by Schedule '4B Subdivision District – Minimum Parcel Sizes'	1
3) Height	9.0m
4) Parcel Coverage	25%

Minimum Setback Requirements

1. All agriculture or farm buildings, structures and uses – in accordance with Section 3.3.10
2. All other buildings and structures

All lot lines	8.0 m
---------------	-------

¹ Bylaw No. 500.407, adopted October 3, 2017

R U R A L 1.1 continued

except where:

- a) the parcel is less than 4000 m² in area then the setback from lot lines may be reduced to 2.0 m from an interior side lot line and to 5.0 m from other lot lines, excluding the front lot line;
- b) any part of a parcel is adjacent to or contains a watercourse then the regulations in Section 3.3.8 shall apply.

Section 3.4.82

RURAL 2¹**RU2****Permitted Uses and Minimum Site Area**

Required Site Area with:

Permitted Uses	Community Water & Sewer System	Community Water System	No Community Services
a) Agriculture	n/a	n/a	n/a
b) Animal Care	2.0 ha	2.0 ha	2.0 ha
c) Aquaculture	5000 m ²	5000 m ²	5000 m ²
d) Campground	1.0 ha	1.0 ha	2.0 ha
e) Home Based Business ²	n/a	n/a	n/a
f) Nursery	n/a	n/a	n/a
g) Produce Stand	n/a	n/a	n/a
h) Residential Use	n/a	n/a	n/a
i) Silviculture	n/a	n/a	n/a
j) Secondary Suite ³	n/a	n/a	n/a

Maximum Number and Size of Buildings and Structures⁴

1. Accessory buildings	combined floor area of 400 m ²
2. Dwelling units/parcel:	
a) on a parcel having an area of 2.0 ha or less	1
For Electoral Areas 'A,C,E and H'	
b) on a parcel having an area greater than 2.0 ha	2
For Electoral Area 'G'	
c) on a parcel having an area equal to or greater than twice the minimum parcel size as established by Schedule '4B Subdivision District – Minimum Parcel Sizes'	2
d) Notwithstanding subsection (c), on a parcel located in this zone and created prior to February 22, 2011 and having an area greater than 2.0 ha	2
3. Height	9.0 m
4. Parcel coverage	25%

¹ Bylaw No.500.23, adopted June 14, 1988² Bylaw No.500.270, adopted November 13, 2001³ Bylaw No. 500.389, adopted May 27, 2014⁴ Bylaw No. 500.359, adopted January 25, 2011

R U R A L 2 continued

Minimum Setback Requirements

1. All agriculture or farm buildings, structures and uses – in accordance with Section 3.3.10¹
2. All other buildings and structures
All lot lines - 8.0 m

except where any part of a parcel is adjacent to or contains a watercourse then the regulations in Section 3.3.8 shall apply.

¹ Bylaw No. 500.402, adopted June 28, 2016

Section 3.4.83

RURAL 3¹**RU3****Permitted Uses and Minimum Site Area**

Permitted Uses ²	Required Site Area with:		
	Community Water & Sewer System	Community Water System	No Community Services
a) Agriculture	n/a	n/a	n/a
b) Aquaculture	5000 m ²	5000 m ²	5000 m ²
c) Home Based Business ³	n/a	n/a	n/a
d) Produce Stand	n/a	n/a	n/a
e) Residential Use	n/a	n/a	n/a
f) Silviculture	n/a	n/a	n/a
g) Wood Processing	2.0 ha	2.0 ha	2.0 ha
h) Secondary Suite ⁴	n/a	n/a	n/a

Maximum Number and Size of Buildings and Structures⁵

1. Accessory buildings	combined floor area of 400 m ²
2. Dwelling units/parcel:	
a) on a parcel having an area of 2.0 ha or less	1
For Electoral Areas 'A,C,E and H'	
b) on a parcel having an area greater than 2.0 ha	2
For Electoral Area 'G'	
c) on a parcel having an area equal to or greater than twice the minimum parcel size as established by Schedule '4B' Subdivision Districts–Minimum Parcel Sizes	2
d) Notwithstanding subsection (c), on a parcel located in this zone and created prior to February 22, 2011 and having an area greater than 2.0 ha	2
3. Height	9.0 m
4. Parcel coverage	25%

Minimum Setback Requirements

- All agriculture or farm buildings, structures and uses – in accordance with Section 3.3.10⁶
- All other buildings and structures
All lot lines - 8.0 m

except where any part of a parcel is adjacent to or contains a watercourse then the regulations in Section 3.3.8 shall apply.

¹ Bylaw No. 500.23, adopted June 14, 1988

² Bylaw No. 500.362, adopted January 25, 2011

³ Bylaw No. 500.270, adopted November 13, 2001

⁴ Bylaw No. 500.389, adopted May 27, 2014

⁵ Bylaw No. 500.359, adopted January 25, 2011

⁶ Bylaw No. 500.402, adopted June 28, 2016

Section 3.4.84¹**RURAL 4****RU4****Permitted Uses and Minimum Site Area**

Required Site Area with:

Permitted Uses	Community Water & Sewer System	Community Water System	No Community Services
a) Agriculture	n/a	n/a	n/a
b) Aquaculture	5000 m ²	5000 m ²	5000 m ²
c) Home Based Business ²	n/a	n/a	n/a
d) Produce Stand	n/a	n/a	n/a
e) Residential Use	n/a	n/a	n/a
f) Silviculture	n/a	n/a	n/a
g) Secondary Suite ³	n/a	n/a	n/a

Maximum Number and Size of Buildings and Structures

1. Accessory buildings - combined floor area of 400 m² ⁴
 2. Dwelling units/parcel:
 - a) on a parcel having an area of 2.0 ha or less - 1
 - b) on a parcel having an area greater than 2.0 ha - 2
- Height 9.0 m ⁵
- Parcel coverage 25%

Minimum Parcel Area

Subject to Section 4.4.4, no parcel having an area less than 2.0 ha may be created by subdivision, and for the purposes of this subsection, "parcel" includes a lot created by deposit of a strata plan under the **Strata Property Act** (British Columbia).

Minimum Setback Requirements

1. All agriculture or farm buildings, structures and uses – in accordance with Section 3.3.10⁶
2. All other buildings and structures
All lot lines - 8.0 m

except where:

the parcel is less than 4000 m² in area then the setback from lot lines may be reduced to 2.0m from an interior side lot line and to 5.0 m from other lot lines, excluding the front lot line;

any part of a parcel is adjacent to or contains a watercourse then the regulations in Section 3.3.8 shall apply.

¹ Bylaw No. 500.206, adopted November 12, 1996

² Bylaw No. 500.270, adopted November 13, 2001

³ Bylaw No. 500.389, adopted May 27, 2014

⁴ Bylaw No. 500.272, adopted November 13, 2001

⁵ Bylaw No. 500.246, adopted December 8, 1998

⁶ Bylaw No. 500.402, adopted June 28, 2016

Section 3.4.85

RURAL 5¹

RU5

Permitted Uses and Minimum Site Area

Required Site Area with:

Permitted Uses	Community Water & Sewer System	Community Water System	No Community Services
a) Agriculture	n/a	n/a	n/a
b) Aquaculture	5000 m ²	5000 m ²	5000 m ²
c) Home Based Business ²	n/a	n/a	n/a
d) Produce Stand	n/a	n/a	n/a
e) Residential Use	n/a	n/a	n/a
f) Silviculture	n/a	n/a	n/a
g) Secondary Suite ³			

Maximum Number and Size of Buildings and Structures

Accessory buildings - combined floor area 400 m² ⁴

Dwelling units/parcel:

a) on a parcel having an area of 2.0 ha or less - 1

b) on a parcel having an area greater than 2.0 ha - 2

Height 9.0 m⁵

Parcel coverage 25%

Minimum Setback Requirements

1. All agriculture or farm buildings, structures and uses – in accordance with Section 3.3.10⁶

2. All other buildings and structures

All lot lines - 8.0 m

except where:

the parcel is less than 4000 m² in area then the setback from lot lines may be reduced to 2.0 m from an interior side lot line and to 5.0 m from other lot lines, excluding the front lot line;

any part of a parcel is adjacent to or contains a watercourse then the regulations in Section 3.3.8 shall apply.

¹ Bylaw No. 500.218, adopted August 12, 1997 (Introduces RU5)

² Bylaw No. 500.270, adopted November 13, 2001

³ Bylaw No. 500.389, adopted May 27, 2014

⁴ Bylaw No. 500.272, adopted November 13, 2001

⁵ Bylaw No. 500.246, adopted December 8, 1998

⁶ Bylaw No. 500.402, adopted June 28, 2016

Section 3.4.86

RURAL 6¹

RU6

3.4.86.1 Permitted Uses and Minimum Site Area

Required Site Area with:

Permitted Uses	Community Water & Sewer System	Community Water System	No Community Services
a) Agriculture	n/a	n/a	n/a
b) Aquaculture	5000 m ²	5000 m ²	5000 m ²
c) Home Based Business ²	n/a	n/a	n/a
d) Produce Stand	n/a	n/a	n/a
e) Residential Use	n/a	n/a	n/a
f) Silviculture	n/a	n/a	n/a
g) Secondary Suite ³			

3.4.86.2. Maximum Number and Size of Buildings and Structures

- a) Accessory buildings - combined floor area 400 m² ⁴
- b) Dwelling units/parcel -1
- c) Height 9.0 m
- d) Parcel coverage 25%

3.4.86.3 Minimum Setback Requirements

- a) All agriculture or farm buildings, structures and uses – in accordance with Section 3.3.10⁵
- b) All other buildings and structures
 - All lot lines - 8.0 m
 - except:
 - for Lots 1 to 18, District Lot 5, Douglas District (situated partly in Cranberry District), Plan VIP 59461 where buildings and structures do not house livestock or store manure, the following setbacks shall apply:
 - Front lot line - 7.5 m
 - Interior and exterior side lot lines - 3.0 m
 - Rear lot line - 4.5 m
 - Other lot lines - 1.5 m
 - where any part of a parcel is adjacent to or contains a watercourse then the regulations in Section 3.3.8 shall apply.

¹ Bylaw No. 500.253, adopted January 1, 2000
² Bylaw No. 500.270, adopted November 13, 2001
³ Bylaw No. 500.389, adopted May 27, 2014
⁴ Bylaw No. 500.272, adopted November 13, 2001
⁵ Bylaw No. 500.402, adopted June 28, 2016

Section 3.4.87

RURAL 7¹

RU7

3.4.87.1 Permitted Uses and Minimum Site Area

Required Site Area with:

Permitted Uses	Community Water & Sewer System	Community Water System	No Community Services
a) Agriculture	n/a	n/a	n/a
b) Aquaculture	5000 m ²	5000 m ²	5000 m ²
c) Home Based Business ²	n/a	n/a	n/a
d) Produce Stand	n/a	n/a	n/a
e) Residential Use	n/a	n/a	n/a
f) Silviculture	n/a	n/a	n/a
g) Secondary Suite ³			

3.4.87.2 Maximum Number and Size of Buildings and Structures

- a) Accessory buildings - combined floor area 400 m² ⁴
- b) Dwelling units/parcel:
 - i) on a parcel having an area of 2.0 ha or less - 1
 - ii) on a parcel having an area greater than 2.0 ha - 2
- c) Height - 9.0 m
- d) Parcel coverage - 25%

3.4.87.3 Minimum Parcel Area

Subject to Section 4.4.4, no parcel having an area less than the applicable subdivision district as stated in Section 4.1 may be created by subdivision, and for the purposes of this subsection, "parcel" includes a lot created by deposit of a strata plan under the **Strata Property Act** (British Columbia) but excludes a bare land strata lot.

3.4.87.4 Minimum Setback Requirements

- a) All agriculture or farm buildings, structures and uses – in accordance with Section 3.3.10⁵
- b) All other buildings and structures
 - All lot lines - 8.0 m

except where any part of a parcel is adjacent to or contains a watercourse then the regulations in Section 3.3.8 shall apply.

¹ Bylaw No. 500.253, adopted January 11, 2000
² Bylaw No. 500.270, adopted November 13, 2001
³ Bylaw No. 500.389, adopted May 27, 2014
⁴ Bylaw No. 500.272, adopted November 13, 2001
⁵ Bylaw No. 500.402, adopted June 28, 2016

Section 3.4.88

RURAL 8¹**RU8****3.4.88.1 Permitted Uses and Minimum Site Area**

Required Site Area with:

Permitted Uses	Community Water & Sewer System	Community Water System	No Community Services
a) Agriculture	n/a	n/a	n/a
b) Aquaculture	5000 m ²	5000 m ²	5000 m ²
c) Home Based Business ²	n/a	n/a	n/a
d) Produce Stand	n/a	n/a	n/a
e) Residential Use	n/a	n/a	n/a
f) Silviculture	n/a	n/a	n/a
g) Secondary Suite ³			

3.4.88.2 Maximum Number and Size of Buildings and Structures

- a) Accessory buildings - combined floor area 400 m² ⁴
- b) Dwelling units/parcel:
 - i) on a parcel having an area 8.0 ha or less -1
 - ii) on a parcel having an area greater than 8.0 ha -2
- c) Despite Section 3.4.88.2 b) ii), the maximum permitted density of one of the parcels located within an eligible subdivision shall be two dwelling units provided the parcel is greater than 8.0 hectares.
- d) After the development of 2 dwelling units on the parcel referred to in Section 3.4.88.2 (c), the maximum permitted density of all other parcels located within the eligible subdivision shall be 1 dwelling unit per parcel.
- e) Height - 9.0 m
- f) Parcel coverage - 25%

3.4.88.3 Minimum Parcel Area

Subject to Section 4.4.4, no parcel having an area less than the applicable subdivision district as stated in Section 4.1 may be created by subdivision, and for the purposes of this subsection, "parcel" includes a lot created by deposit of a strata plan under the **Strata Property Act** (British Columbia) but excludes a bare land strata lot.

¹ Bylaw No.500.253, adopted January 11, 2000

² Bylaw No.500.270, adopted November 13, 2001

³ Bylaw No. 500.389, adopted May 27, 2014

⁴ Bylaw No.500.272, adopted November 13, 2001

RURAL 8 continued

3.4.88.4 Minimum Setback Requirements

- a) All agriculture or farm buildings, structures and uses – in accordance with Section 3.3.10¹
- b) All other buildings and structures
 - All lot lines - 8.0 m

except where any part of a parcel is adjacent to or contains a watercourse then the regulations in Section 3.3.8 shall apply.

¹ Bylaw No. 500.402, adopted June 28, 2016

Section 3.4.89

RURAL 9¹

RU9

3.4.89.1 Permitted Uses and Minimum Site Area

Required Site Area with:

Permitted Uses	Community Water & Sewer System	Community Water System	No Community Services
a) Agriculture	n/a	n/a	n/a
b) Aquaculture	5000 m ²	5000 m ²	5000 m ²
c) Home Based Business ²	n/a	n/a	n/a
d) Produce Stand	n/a	n/a	n/a
e) Residential Use	n/a	n/a	n/a
f) Silviculture	n/a	n/a	n/a
g) Secondary Suite ³	n/a	n/a	n/a

3.4.89.2 Maximum Number and Size of Buildings and Structures

- a) Accessory buildings - combined floor area 400 m² ⁴
- b) Dwelling units/parcel:
 - i) on a parcel having an area of 2.0 ha or less - 1
 - ii) on a parcel having an area greater than 2.0 ha - 2
- c) Despite Section 3.4.89.2 b) ii), the maximum permitted density of one of the parcels located within an eligible subdivision shall be two dwelling units provided the parcel is greater than 2.0 hectares.
- d) After the development of two dwelling units on the parcel referred to in Section 3.4.89.2 (c), the maximum permitted density of all other parcels located within the eligible subdivision shall be one dwelling unit per parcel.
- e) Height - 9.0 m
- f) Parcel coverage - 25%

3.4.89.3 Minimum Setback Requirements

- a) All agriculture or farm buildings, structures and uses – in accordance with Section 3.3.10⁵
- b) All other buildings and structures
 - All lot lines - 8.0 m

except where any part of a parcel is adjacent to or contains a watercourse then the regulations in Section 3.3.8 shall apply.

¹ Bylaw No.500.253, adopted January 11, 2000
² Bylaw No.500.270, adopted November 13, 2001
³ Bylaw No. 500.389, adopted May 27, 2014
⁴ Bylaw No.500.272, adopted November 13, 2001
⁵ Bylaw No. 500.402, adopted June 28, 2016

Section 3.4.810

RURAL 10¹

RU10

3.4.810.1 Permitted Uses, Density, and Park Amenity

Permitted Uses

- a) Residential Use
- b) Home Based Business Use
- c) Secondary Suite²

Density and Park Land Amenity

For the parcels legally described as Lot 1, District Lot 84, Nanoose District, Plan 47545, Lot 2, District Lot 84, Nanoose District, Plan 47545, and Lot A, District Lot 84 Nanoose District Plan VIP80224, the following applies:

- a) The maximum number of parcels that may be created by subdivision within the area as shown outlined on Schedule No. 2 of the Rural 10 zone shall be a maximum of 5 fee simple parcels.
 - b) The park land amenity is the transfer of lands for community park and is a trail corridor 10 metres to 15 metres in width connecting the proposed cul-de-sac road to the south east corner of Lot A District Lot 84 Nanoose District Plan VIP80224.
-

3.4.810.2 Maximum Number and Size of Buildings and Structures

Accessory buildings	Combined floor area 400 m ²
Dwelling units/parcel	1
Height of buildings	9.0 m
Parcel coverage	10%

3.4.810.3 Minimum Setback Requirements

For all buildings and structures

All lot lines 8.0 metres

Except where any part of the parcel is adjacent to or contains a watercourse then the regulations of section 3.3.8 shall apply.

3.4.810.4 Minimum Parcel Size

Minimum parcel size 4.0 ha

Despite the minimum parcel size, for the parcels legally described as Lot 1, District Lot 84, Nanoose District, Plan 47545, Lot 2, District Lot 84, Nanoose District, Plan 47545, and Lot A, District Lot 84 Nanoose District Plan VIP80224, the following applies:

a maximum of 3 fee simple parcels may be parcel averaged based on the total size of the parent parcel divided by the number of fee simple parcels created provided that the total number of fee simple parcels does not exceed 5 and the smallest parcel is not less than 2.94 ha in size.

¹ Bylaw No. 500.348, adopted April 28, 2009

² Bylaw No. 500.389, adopted May 27, 2014

RURAL 10 continued

3.4.810.5 Other Regulations

For the purpose of this zone:

- a) Home Based Business Use – a home based business use shall be restricted to an office home based business only provided it is fully contained within a single dwelling unit and all other applicable regulations set out in section 3.3.14 apply to this zone.
- b) Despite section 3.3.5), the keeping of animals shall be restricted pets and household animals.

Section 3.4.91

WATER 1

WA1

Permitted Uses and Minimum Site Area

Required Site Area with:

Permitted Uses	Community Water & Sewer System	Community Water System	No Community Services
a) Aquaculture	5000 m ²	5000 m ²	5000 m ²
b) Boat Ramp	2000 m ²	2000 m ²	2000 m ²

Maximum Number and Size of Buildings and Structures

Height ¹ 1.0 m above surface of water measured from the natural boundary

Minimum Setback Requirements

All lot lines or lease boundaries - 3.0 m

¹ Bylaw No.500.174, adopted October 10, 1995

Section 3.4.92

WATER 2

WA2

Permitted Uses and Minimum Site Area

Required Site Area with:

Permitted Uses	Community Water & Sewer System	Community Water System	No Community Services
a) Boat Ramp	2000 m ²	2000 m ²	2000 m ²
b) Marina	1.0 ha	1.0 ha	1.0 ha
c) Marina Sales	5000 m ²	5000 m ²	5000 m ²
d) Outdoor Recreation Use	5000 m ²	5000 m ²	5000 m ²

Maximum Number and Size of Buildings and Structures

Height 5.0 m above surface of water measured from the natural boundary

Minimum Setback Requirements

All lot lines or lease boundaries - 3.0 m

Section 3.4.93

WATER 3

WA3

Permitted Uses and Minimum Site Area

Required Site Area with:

Permitted Uses	Community Water & Sewer System	Community Water System	No Community Services
a) Boat Building & Repair	1.0 ha	1.0 ha	1.0 ha
b) Log Storage & Sorting Yard	2.0 ha	2.0 ha	2.0 ha
c) Marina	1.0 ha	1.0 ha	1.0 ha
d) Marine Fuel Supply Station	5000 m ²	5000 m ²	5000 m ²
e) Shipping Yard	2.0 ha	2.0 ha	2.0 ha

Maximum Number and Size of Buildings and Structures

Height 12.0 m above surface of water measured from the natural boundary

Minimum Setback Requirements

All lot lines or lease boundaries - 5.0 m

Section 3.4.94

WATER 4¹

WA4

3.4.94.1 Permitted Uses and Minimum Site Area

Permitted Uses

- a) Dock
 - b) Boat Ramp
 - c) Wharf
-

3.4.94.2 Maximum Number and Size of Buildings Structures and Uses²

- a) Area
 - i) Dock – A maximum of 25 recreational residences permitted under the Horne Lake CD9 zone may have a maximum of 40m² of dock area excluding access walkways or ramps that do not exceed 1.22m in width and the maximum dock area for all other recreational residences permitted under the Horne Lake CD9 zone shall not exceed 20m² excluding access walkways or ramps that do not exceed 1.22m in width.
 - ii) Dock – A maximum of 2 swimming docks not exceeding a maximum dock area of 10m² is permitted for the Horne Lake Regional Park.
 - iii) Wharf – A maximum of 1 boat wharf not exceeding a maximum area of 20m² is permitted for the Horne Lake Regional Park excluding access walkways or ramps that do not exceed 1.22m in width.
 - iv) Boat ramp – A maximum of 2 boat ramps are permitted at Horne Lake. One located at the Horne Lake Regional Park and one located between strata lots 373 and 374.
 - b) Height
 - i) Docks and wharves shall not exceed 1.0m above the surface of the water excluding diving boards and slides that do not exceed 2.5m above the surface of the water and that are not contained within a building.
-

3.4.94.3 Minimum Setback Requirements

All lot lines - 0.0 m

3.4.94.4 Other Regulations

- a) For the purposes of this zone dock means a floating structure for the mooring of boats;
- b) For the purposes of this zone no accessory uses, buildings or structures including fences under 2.0 m in height are permitted;
- c) In the event of inconsistency between any provision of Section 3.4.94 and any other provision of this Bylaw, the Section 3.4.94 provision will apply and the other provision will not apply to the extent of the inconsistency.

¹ Bylaw No.500.275, adopted October 9, 2001

² Bylaw No.500.314, adopted January 10, 2006

Section 3.4.103

SCHOONER HOUSE COMPREHENSIVE DEVELOPMENT¹ Zone 4

CD4

Permitted Uses and Minimum Site Area

Permitted Uses	Required Site Area with: Community Water & Sewer System
a) Multiple Dwelling Unit Development	1.036 ha

Maximum Number and Size of Buildings and Structures

Dwelling units/parcel	49
Height	20.0 m
Parcel coverage	35%

Minimum Setback Requirements

1. In a Multiple Dwelling Unit development or on a parcel divided pursuant to the **Strata Property Act** and not contained within a Bare Land Strata Plan:

All lot lines	10.0 m
---------------	--------
2. All other buildings and structures:

Front and exterior lot lines	8.0 m
Other lot lines	3.0 m

except where any part of a parcel is adjacent to or contains a watercourse then the regulations in Section 3.3.8 shall apply.

¹ Bylaw No.500.130, adopted January 12, 1993

Section 3.4.104

WEMBLEY COMPREHENSIVE DEVELOPMENT ZONES¹

CD5

Permitted Uses and Minimum Site Area

Permitted Uses	Required Site Area with: Community Water & Sewer System
a) Multiple Dwelling Unit Development	2.3 ha

Maximum Number and Size of Buildings and Structures

Dwelling units/parcel	102
Height	13.0 m
Parcel coverage	35%
Floor Area Ratio	0.70

Minimum Setback Requirements

1. In a Multiple Dwelling Unit development or on a parcel divided pursuant to the **Strata Property Act** and not contained within a Bare Land Strata Plan:

All lot lines	10.0 m
---------------	--------
2. All other buildings and structures:

Front and exterior lot lines	8.0 m
Other lot lines	3.0 m

except where any part of a parcel is adjacent to or contains a watercourse then the regulations in Section 3.3.8 shall apply.

¹ Bylaw No.500.207, adopted March 11, 1997

Section 3.4.105

BOWSER VILLAGE COMPREHENSIVE DEVELOPMENT Zone 6¹

CD6

Permitted Uses

Any combination of the following uses shall be permitted with a community water system:

- a) retail store
- b) office
- c) personal service use
- d) restaurant
- e) tourist store
- f) recreation facility
(excluding pool hall, bowling alley,
curling, roller rink and swimming pool)
- g) multiple dwelling unit development
- h) emergency services²

Maximum Number and Size of Buildings and Structures

Height	10.0 m
Parcel coverage	25%
Floor Area Ratio	0.50
Dwelling Units	5 dwelling units per hectare

Minimum Setback Requirements

All lot lines 5.0 metres

Except where:

- a) The adjoining parcel is zoned industrial or commercial gthan the setback from the common interior side lot line may be reduced to zero³.

¹ Bylaw No. 500.219, adopted September 9, 1997

² Bylaw No. 500.386, adopted November 26, 2013

³ Bylaw No. 500.386, adopted November 26, 2013

Section 3.4.106

**FAIRWINDS COMPREHENSIVE
DEVELOPMENT ZONE 8¹**

CD8

3.4.106.1 Permitted Uses

- a) Office [refer to 3.4.106.4 a)]
- b) Personal Service Use [refer to 3.4.106.4 b)]
- c) Recreation Facility
- d) Restaurant
- e) Retail Store

3.4.106.2 Maximum Number and Size of Buildings and Structures

- | | |
|---------------------|--|
| a) Office | The combined total floor area of all office uses must not exceed 375m ² |
| b) Restaurant | The combined total floor area of all restaurants must not exceed 100m ² |
| c) Retail Store | The combined total floor area of all retail stores must not exceed 100m ² |
| d) Floor Area Ratio | 0.25 |
| e) Height | 12.0 m |
| f) Parcel coverage | 20% |

3.4.106.3 Minimum Setback Requirements

All lot lines 5.0 metres

except where

- a) the adjoining parcel is zoned industrial or commercial then the setback from the common interior side lot line may be reduced to zero;
- b) any part of a parcel is adjacent to or contains a watercourse then the regulations in Section 3 of this Part shall apply.

3.4.106.4 Other Regulations

- a) For the purpose of this zone, the use "office" is limited to:
real estate sales,
 - i) real estate information center,
 - ii) management of business.
- b) For the purpose of this zone, "personal service use" is limited to fitness training services.
- c) In the event of inconsistency between any provision of Section 3.4.106.4 and any other provision of this Bylaw, the Section 3.4.106.4 provision will apply and the other provision will not apply to the extent of the inconsistency.

¹ Bylaw No.500.263, adopted October 10, 2000

Comprehensive Development Zone CD8
Schedule 2

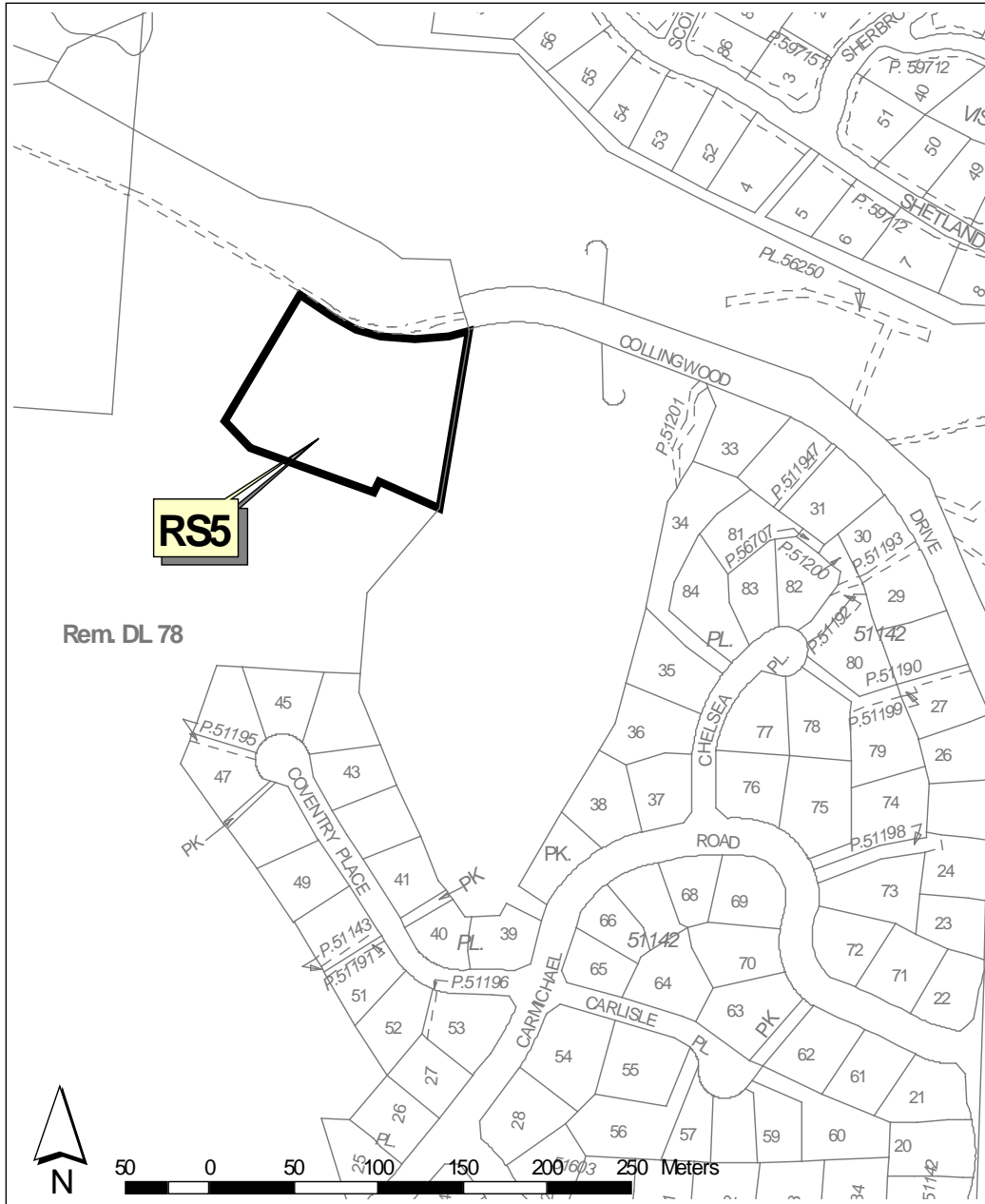

Comprehensive Development Zone CD8 Schedule 3

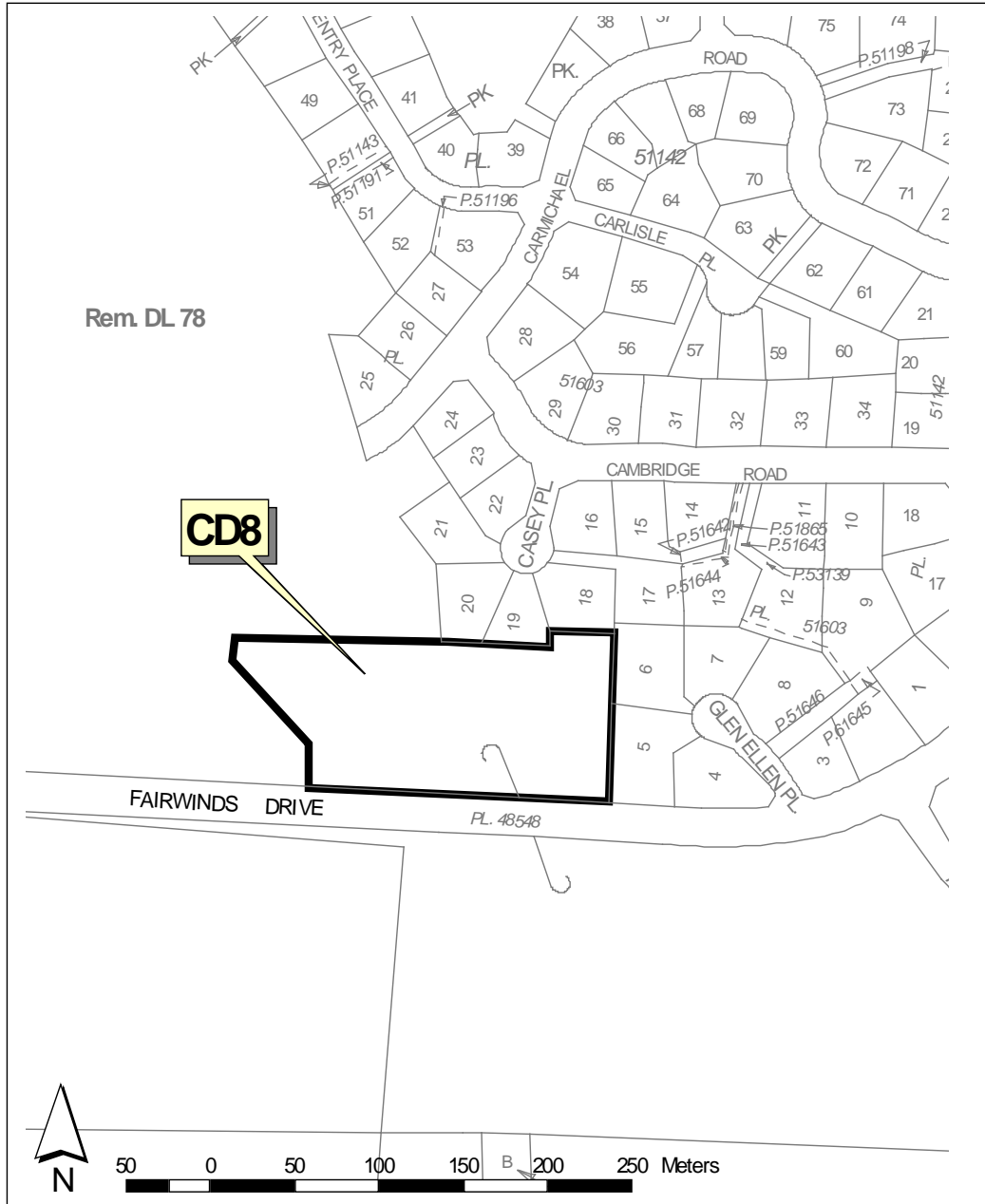

Section 3.4.107

**HORNE LAKE COMPREHENSIVE
DEVELOPMENT ZONE 9¹**

CD9

3.4.107.1 Permitted Uses

- a) Recreational Residence
 - b) Recreational Vehicle Storage Area
-

3.4.107.2 Maximum Number and Size of Buildings Structures and Uses

- a) The maximum number of recreational residences permitted within the area as shown outlined on plan contained in Schedule CD9 'A', shall be:
 - i) 400, where the regional park amenity referred to in subsection (f)² is provided to the regional district; or
 - ii) 2, where the regional park amenity has not been provided.
- b) Number of recreational residences per bare land strata lot - 1
- c) Floor Area:
 - i) cabin – 70 m² subject to subsections 3.4.107.6 (a)(xi) and 3.4.107.6 (a)(xiii)
 - ii) visitor recreational vehicle – 37m²
 - iii) accessory buildings - one 10 m² and one 6 m² for each recreational residence
 - iv) accessory water storage structure – 6.0m² for each recreational residence³
 - v) accessory wood storage structure – 6.0m² for each recreational residence⁴
- d) Height (recreational residence):
 - i) cabin – 6.1 m
 - ii) accessory buildings and structures - 3.0m
 - iii) accessory water storage structure – 3.0m excluding water container⁵
 - iv) accessory wood storage structure – 3.0m⁶
- e) Storeys
 - i) The maximum number of storeys contained within a cabin must not exceed 2.
 - ii) Where 2 storeys are provided within a cabin either the floor area of the storey with the highest elevation does not exceed 50% of the floor area of the lower storey not including internal stairways or the floor area of the storey with the lower elevation must not exceed 50% of the floor area of the upper storey.⁷
- f) The Regional park amenity is the transfer to the Regional District of the lands legally described Block 40, Alberni District, Plan 691N, Except That Part Thereof Shown Outlined in Red on Plan 1339R and except That Part in Plan 46603 in substantially the same condition as such lands were as of May 31, 2001, to be operated and maintained by or on behalf of the Regional District as regional park.

¹ Bylaw No. 500.275, adopted October 9, 2001

² Bylaw No. 500.314, adopted January 10, 2006

³ Bylaw No. 500.314, adopted January 10, 2006

⁴ Bylaw No. 500.314, adopted January 10, 2006

⁵ Bylaw No. 500.314, adopted January 10, 2006

⁶ Bylaw No. 500.314, adopted January 10, 2006

⁷ Bylaw No. 500.314, adopted January 10, 2006

**HORNE LAKE COMPREHENSIVE
DEVELOPMENT ZONE 9 continued**

3.4.107.3 Minimum Parcel Size

Despite Section 4.1 and 4.4.4 of this bylaw, the following subdivision regulations apply:

- a) Maximum number of bare land strata lots that may be subdivided within the CD9 zone – 400
-

3.4.107.4 Minimum Setback Requirements

All watercourses, except Horne Lake	15.0 m from the natural boundary or where a bank is within 15 metres of the natural boundary, 15.0 m from the top of the bank, whichever is greater.
Horne Lake	8.0 m from the natural boundary as shown on the survey plan prepared by Bruce Lewis, BCLS and dated March 15, 2000.
Interior side lot line	1.5 m
Rear lot line	1.5 m
All other lot lines	5.0 m

3.4.107.5 Flood Control¹

- a) The following Lands are designated flood plain:
 - i) That part of Strata Lots 1 through 400, of District Lot 215, Alberni District, Plan VIS5160, Below 121.7 metres Geodetic Survey of Canada Datum.
- b) Despite the designation of the Horne Lake Lands as floodplain and the restrictions contained in subsection (a), a person may construct a permitted minor addition to a building in the Horne Lake Comprehensive Development Zone.
- c) Within the Horne Lake flood plain “a permitted minor addition” means one addition to a cabin located in the Horne Lake Comprehensive Development Zone having an area, which is the lesser of:
 - i) 25% of the floor area of the main floor of the cabin; or
 - ii) 10m²Provided the main floor area of the cabin does not exceed the maximum floor area of 70m² as specified in Section 3.4.107(b)(i) after the one addition.

¹ Bylaw No. 500.314, adopted January 10, 2006

**HORNE LAKE COMPREHENSIVE
DEVELOPMENT ZONE 9 continued**

3.4.107.6 Other Regulations

- a) For the purposes of this zone:
- i) “*recreational residence*” means one cabin, or one cabin and one visitor recreational vehicle
 - ii) “*cabin*” means a building or recreational vehicle used for the temporary accommodation of one or more persons;
 - iii) “*visitor recreational vehicle*” means a tent or one recreational vehicle other than a mobile home located within 100 metres of a cabin, which provides for the accommodation of persons visiting the occupants of the cabin;
 - iv) a visitor recreational vehicle for a given cabin may be located on site for no more than 4 consecutive days within a week with the exception that one visit within a calendar year may extend up to 90 consecutive days;
 - v) “*temporary accommodation*” means the occupation of a cabin for fewer than 180 consecutive days in a calendar year and fewer than 240 days in total during the same calendar year;
 - vi) “*recreational vehicle storage*” means the storage of vehicles used for temporary seasonal accommodation during the periods of time when such vehicles are not in use.
 - vii) No more than 2.0235 hectares (5 acres) of land within the Horne Lake Comprehensive Development Zone 9 shall be used for recreational vehicle storage.
 - viii) The area of land used for recreational vehicle storage shall form one contiguous area and vehicle storage shall not take place in different locations within this zone.
 - ix) The area of land used for recreational vehicle storage shall not be closer than 30 metres from the natural boundary of Horne Lake, 30 metres from the top of a bank adjacent to a watercourse and 5 metres from any other lot line.
 - x) “*storey*” means that portion of a building situated between the top of any floor and the top of the floor next above it, and if there is no floor above it, that portion between the top of the floor and the ceiling above.
 - xi) up to 35m² floor area that is located on a second storey is permitted in addition to the maximum floor area specified in 3.4.107.2(c)(i),¹ not including internal stairways;
 - xii) “*porch*” means a roofed open structure projecting from the exterior wall of a building and having at least 30% of the total areas of the vertical planes forming its perimeter, other than the exterior wall of the building, unobstructed in any manner except by insect screening;
 - xiii) up to 40 m² of floor area used for porches and decks² attached to a cabin is permitted in addition to the maximum floor area specified in 3.4.107.2c) i)³ provided the combined lot coverage “footprint” of the cabin, porch, deck or hard surfaced patio, other than a permitted minor addition of 10 m², does not exceed 93 m² within a setback of 15 metres from the natural boundary of Horne Lake;

¹ Bylaw No. 500.314, adopted January 10, 2006

² Bylaw No. 500.314, adopted January 10, 2006

³ Bylaw No. 500.314, adopted January 10, 2006

**HORNE LAKE COMPREHENSIVE
DEVELOPMENT ZONE 9 continued**

- xiv) Despite section 3.4.107.2 d)¹ i)², a cabin may be up to 8.0 metres in height, where the difference in height between 8.0 metres and 6.1 metres arises from the construction of raised foundations or other construction which does not enclose habitable or occupiable storage space;
 - xv) The keeping of animals for agricultural purposes is not permitted in this zone.
 - xvi) The height of a raised foundation, as set out in subsection (xiv) shall be determined by average natural grade of the footprint of the recreational residence excluding decks and porches;³
 - xvii) The floor area of the storey with the loft (upper or lower), as set out in subsection 3.4.107.2(e)(ii), is calculated exclusive of the portion of the floor area where the height to ceiling is 1.0 metre or less;⁴
 - xviii) Where a lower loft is being constructed the maximum height of the recreational residence shall not exceed 6.1 metres as measured from the lowest point of natural grade;⁵
 - xix) *“accessory water storage structure”* means an unenclosed structure used exclusively for supporting or containing an individual private water supply and may include a container or tank;⁶
 - xx) *“accessory wood storage structure”* means a three sided structure used exclusively for the storage of wood.⁷
- b) In the event of inconsistency between any provision of Section 3.4.107 and any other provision of this Bylaw, the Section 3.4.107 provision will apply and the other provision will not apply to the extent of the inconsistency.

¹ Bylaw No. 500.314, adopted January 10, 2006

² Bylaw No. 500.281, adopted May 14, 2002

³ Bylaw No. 500.314, adopted January 10, 2006

⁴ Bylaw No. 500.314, adopted January 10, 2006

⁵ Bylaw No. 500.314, adopted January 10, 2006

⁶ Bylaw No. 500.314, adopted January 10, 2006

⁷ Bylaw No. 500.314, adopted January 10, 2006

Comprehensive Development Zone CD9 Schedule 3

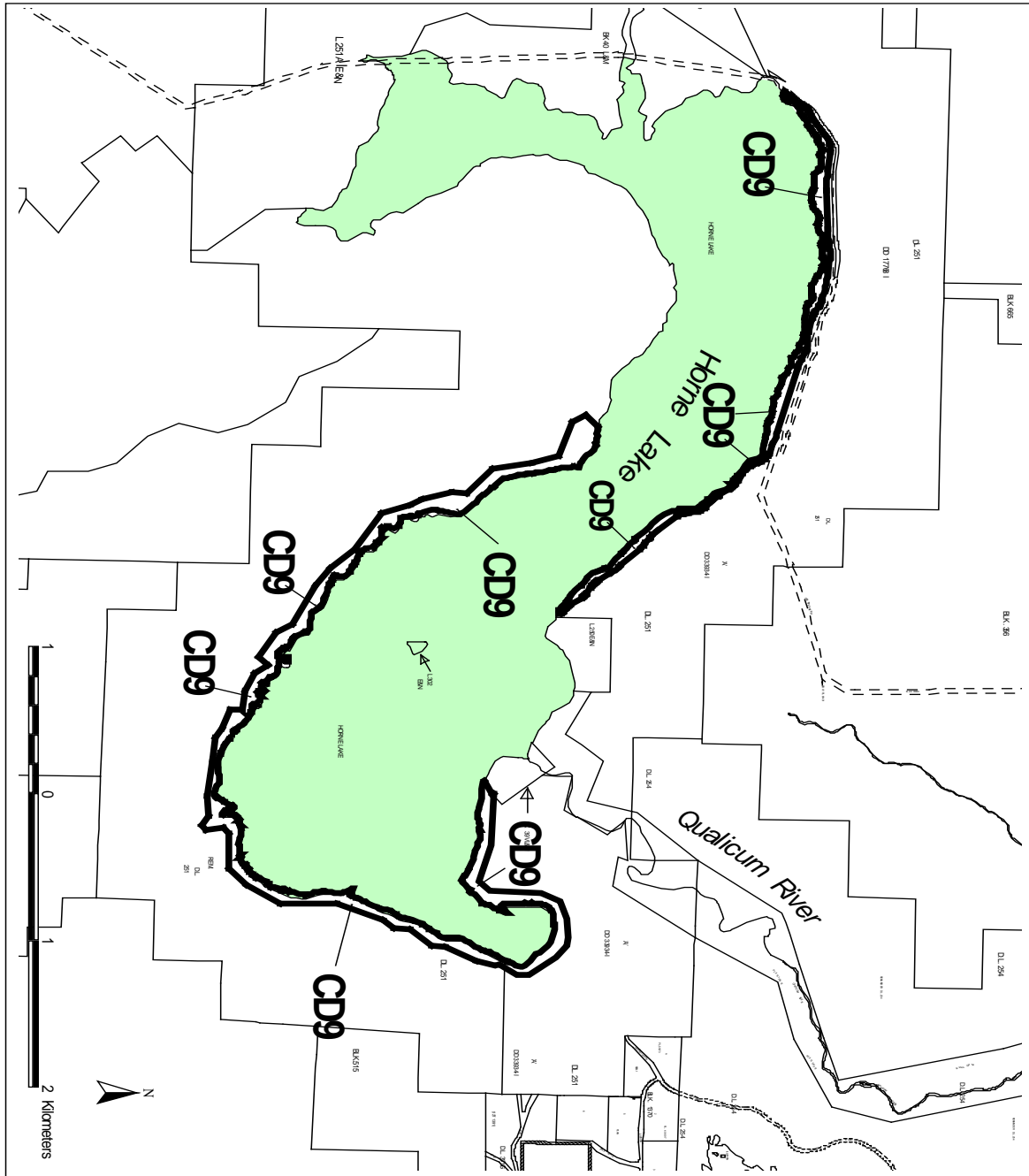

Comprehensive Development Zone CD9 Schedule 5

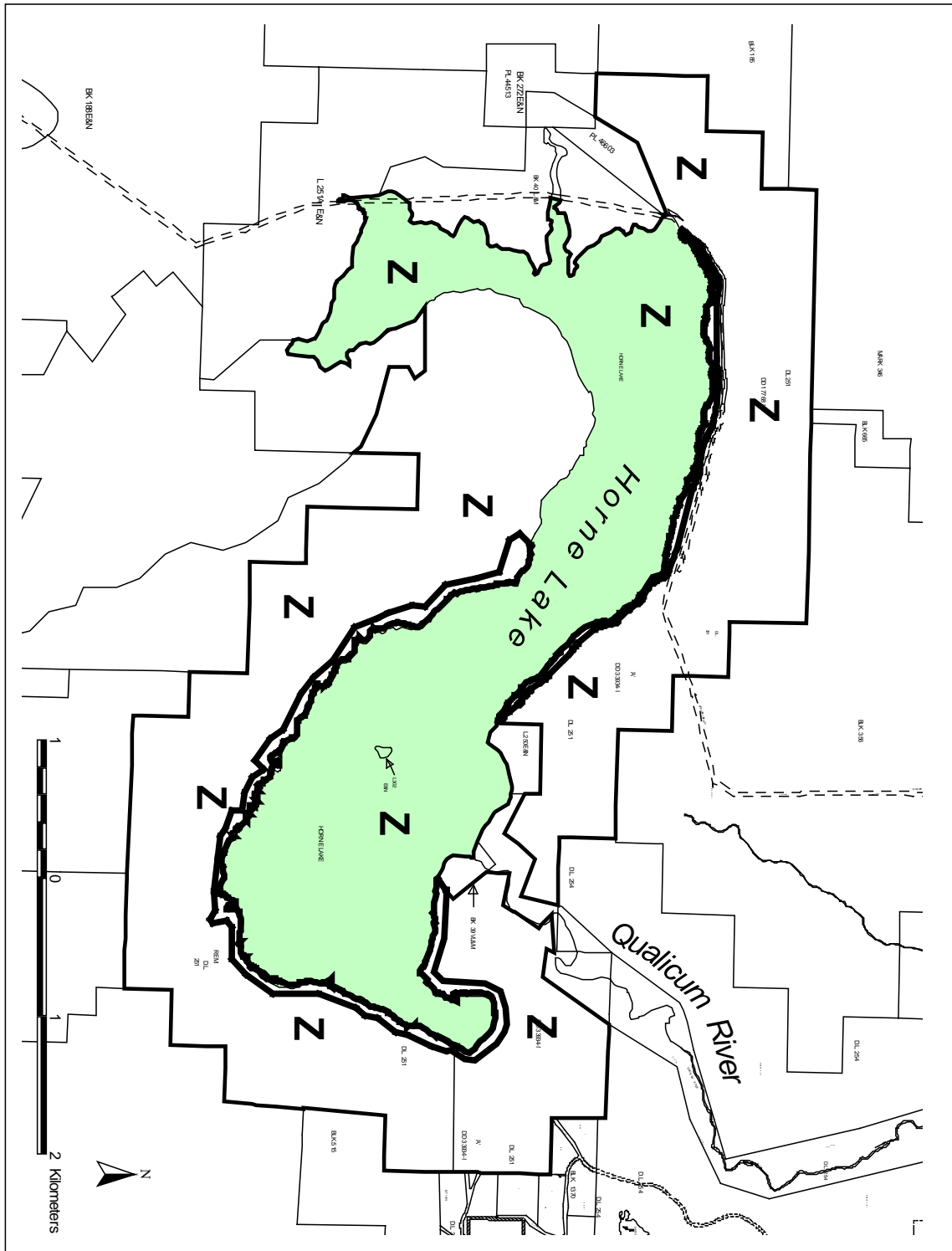

Section 3.4.108

**SOUTH WELLINGTON COMPREHENSIVE
DEVELOPMENT ZONE 10¹****CD10****3.4.108.1****Permitted Uses and Minimum Site Area**

Required Site Area with:

Permitted Uses	Community Water & Sewer System	Community Water System	No Community Services
a) Agriculture	n/a	n/a	n/a
b) Aquaculture	5000 m ²	5000 m ²	5000 m ²
c) Home Occupation Use	n/a	n/a	n/a
d) Produce Stand	n/a	n/a	n/a
e) Residential Use	n/a	n/a	n/a
f) Silviculture	n/a	n/a	n/a
g) Light Industry	n/a	n/a	n/a
h) Outdoor Sales	n/a	n/a	n/a

3.4.108.2 Maximum Number and Size of Buildings and Structures

Accessory buildings:	combined floor area 400 m ²
Light Industry	The combined total floor area of all light industry uses must not exceed 170 m ²
Dwelling units/parcel	
a) on a parcel having an area of 2.0 ha or less	- 1
b) on a parcel having an area greater than 2.0 ha	- 2
Height	- 9.0 m
Parcel coverage	- 25%

3.4.108.3 Minimum Parcel Area

Despite Section 4.4.4, no parcel having an area less than 2.0 ha may be created by subdivision, and for the purposes of this subsection, “parcel” includes a lot created by deposit of a strata plan under the **Strata Property Act** (British Columbia)

3.4.108.4 Minimum Setback Requirements

- 1) Buildings and structures for housing livestock or for storing manure:
 - All lot lines - 30.0 m;
- 2) All other buildings and structures
 - All lot lines - 8.0 m;

except where any part of a parcel is adjacent to or contains a watercourse then the regulations in Section 3.3.8 shall apply.

¹ Bylaw No. 500.278, adopted December 11, 2001

SOUTH WELLINGTON COMPREHENSIVE
DEVELOPMENT ZONE 10¹ continued

3.4.108.5 Other Regulations

- 1) For the purpose of this zone, the “light industry” use is limited to:
 - i) autobody repair with not more than two employees
- 2) For the purpose of this zone, the "outdoor sales" use is limited to:
 - i) the display and sale of automobiles
 - ii) the display of not more than 4 automobiles at any given time
 - iii) the display of sale information attached to each automobile, not exceeding a surface area of 812 cm² , with displayed information including, but not limited to year, make, model description, and sale price of vehicle
 - iv) an outdoor display and sales area of not more than 72 m²
- 3) For the purpose of this zone, and notwithstanding the above-noted Section 2 (iii), signage will be restricted to: not more than 1 free standing indirectly illuminated sign with a surface area of 4.5 m² and not exceeding 6.0 metres in height from its supporting foundation; and the use of ribbon flags, pennants and other on-site display props for advertising is prohibited.
- 4) For the purpose of this zone, the use “home occupation” is limited to the provisions listed for a Rural 4 zone.
- 5) In the event of inconsistency between any provision of Section 3.4.108.5 and any other provision of this Bylaw, the Section 3.4.108.5 provision will apply and the other provision will not apply to the extent of the inconsistency.

¹ Bylaw No. 500.278, adopted December 11, 2001

Section 3.4.109

**SOUTH WELLINGTON 2
COMPREHENSIVE DEVELOPMENT ZONE 11 ¹**

CD11

3.4.109.1**Permitted Uses and Minimum Site Area**

Permitted Uses	Required Site Area with:		
	Community Water & Sewer System	Community Water System	No Community Services
a) Fairground	1.0 ha	1.0 ha	2.0 ha
b) Fast Food Outlet	2000 m ²	4000 m ²	6000 m ²
c) Gasoline Service Station	4000 m ²	5000 m ²	8000 m ²
d) Nursery	4000 m ²	5000 m ²	8000 m ²
e) Heavy Equipment Display	4000 m ²	5000 m ²	8000 m ²
f) Produce Market	4000 m ²	5000 m ²	8000 m ²
g) Public Assembly	4000 m ²	5000 m ²	8000 m ²
h) Recreation Facility	4000 m ²	5000 m ²	8000 m ²
i) Residential Use	n/a	n/a	n/a
j) Restaurant	2000 m ²	4000 m ²	6000 m ²
k) Retail Store	1000 m ²	1600 m ²	2000 m ²

3.4.109.2 Maximum Number and Size of Buildings and Structures

Dwelling units/parcel	- 1
Floor area ratio	- 0.60
Height	- 8.0 m
Parcel coverage	- 50%

3.4.109.3 Minimum Parcel Area

Subject to Section 4.4.4, no parcel having an area less than 2.0 ha may be created by subdivision, and for the purposes of this subsection, “parcel” includes a lot created by deposit of a strata plan under the **Strata Property Act** (British Columbia)

3.4.109.4 Minimum Setback Requirements

Front lot line	- 8.0 m
Other lot lines	- 5.0 m

except where:

- a) the adjoining parcel is zoned industrial or commercial then the setback from the common interior side lot line may be reduced to zero;
- b) any part of a parcel is adjacent to or contains a watercourse then the regulations in Section 3.3.8 shall apply.

¹ Bylaw No. 500.279, adopted June 11, 2002

Section 3.4.111

**RONDALYN RESORT
COMPREHENSIVE DEVELOPMENT ZONE 13**

CD13¹

3.4.111.1 Permitted Uses and Accessory Uses

Permitted Uses

- a) Recreational Vehicle Park

Permitted Accessory Uses

Accessory recreation and service uses that are incidental to the Recreational Vehicle Park use intended for the sole use of RV Park visitors and residents

3.4.111.2 Maximum Number and Size of Buildings, Structures and Uses

Recreational Vehicle Park	Maximum of 90 RV / camping spaces developed in accordance with Schedule '3C' Campground Regulations and Standards. ²
Dwelling units/parcel	- 2
Height	- 8.0 metres
Parcel coverage	- 10%

3.4.111.3 Minimum Setback Requirements

- Front lot lines - 8.0 metres
Other lot lines - 5.0 metres

except where any part of a parcel is adjacent to or contains a watercourse then the regulations in Section 3.3.8 apply;

and except for one free standing sign that meets the requirements of "Regional District of Nanaimo Sign Bylaw No. 993, 1995" within the required setback.

¹ Bylaw No. 500.287, adopted June 13, 2005

² Bylaw No. 500.330, adopted May 23, 2006

Comprehensive Development Zone CD13
Schedule 2 (1 of 2)

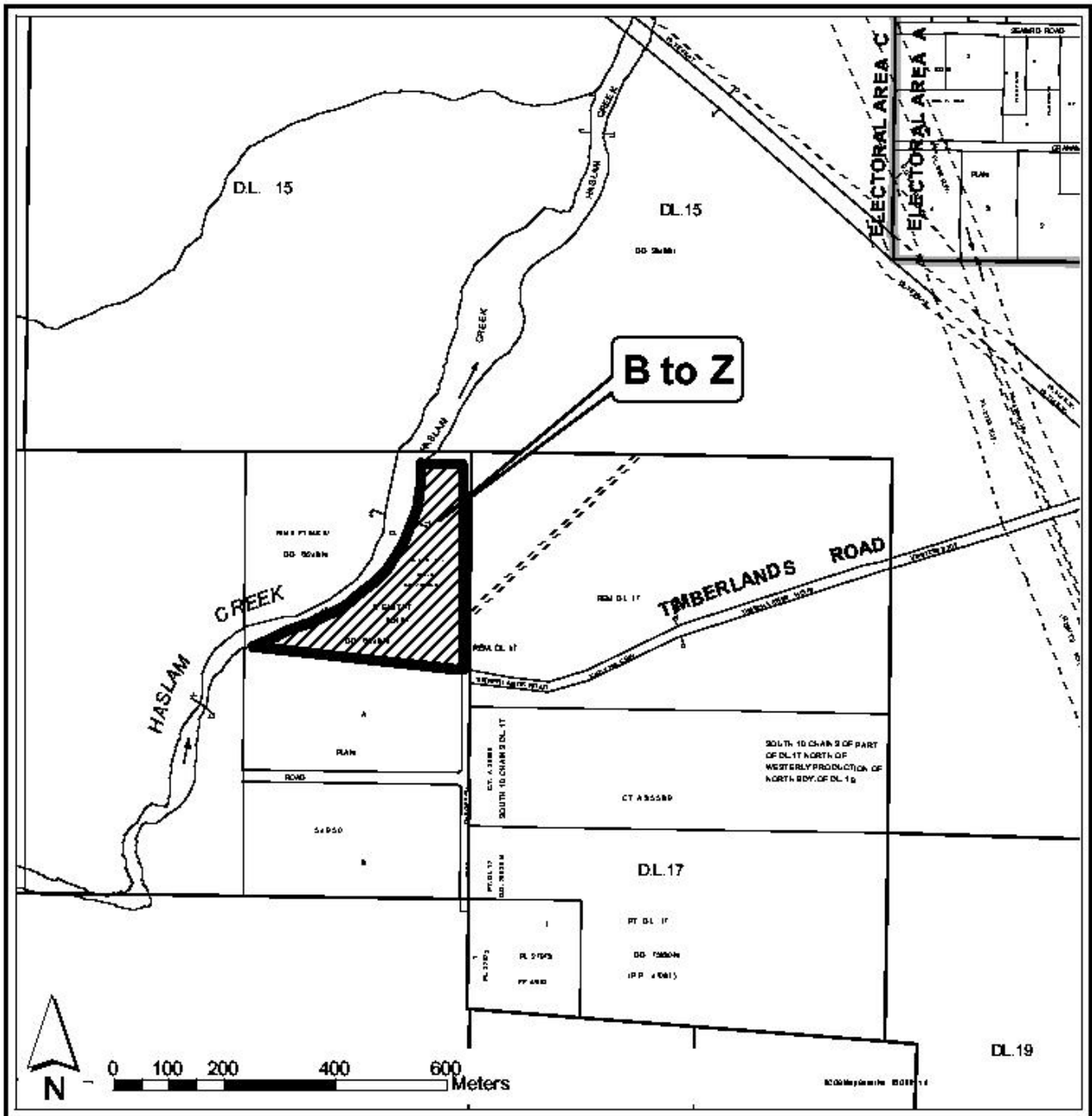

Section 3.4.112

**ENGLISHMAN RIVER (BLOCK 564)
COMPREHENSIVE DEVELOPMENT ZONE 14**

CD14¹

3.4.112.1 Permitted Uses, Density, and Park Amenity

Permitted Uses

- a) Residential Use
 - b) Home Based Business Use
 - c) Agriculture use, within that part of the zone within the ALR
-

Density and Park Amenity

- a) The maximum number of parcels that may be created by subdivision within the area as shown outlined on Schedule No. 2 of the CD 14 zone shall be:
 - i) 158 where the Regional Park amenity referred to in section b) of Section 3.4.112.1 is provided to the Regional District; or
 - ii) 36 parcels where the Regional Park has not been provided.
- b) The Regional Park amenity is the transfer of the following portions of the lands legally described as the Remainder of Block 564, Nanoose District, Except That Part Shown Outlined in Red on Plan 613-R and Except Parts in Plans 360RW, 3132RW, 31833, 39893, 42873, VIP66068, VIP67422, VIP69511 and VIP71158 (The Remainder of Block 564, Nanoose District) for Regional Park:
 - i) A greenway corridor not less than 15.0 metres in width linking a minimum of one (1) accessible location from the top of the bank of the Englishman River to the two (2) locations where Craig Creek crosses the lands and to the location of the unnamed wetland located near the south boundary of the lands;
 - ii) The Craig Creek Corridor and that part of the land east and south of Craig Creek situated west of the Island Highway, including the Bed of the Creek and a minimum 30.0 metres as measured from the top of the bank of the Creek;
 - iii) That portion of land located between DL 57, Nanoose District and the Island Highway that includes all of the area 200 metres south of the Remainder of DL 40 Nanoose District;
 - iv) That portion of land located between the east boundary of DL 57, Nanoose District and the top of the bank of the Englishman River Valley;
 - v) A 30.0-metre wide strip of land located adjacent to the west side of the Island Highway from the south boundary of the Remainder of DL 40, Nanoose District to Kaye Road; and
 - vi) A 30.0 metre wide strip of land located west of that portion of Lot 1, Block 564 and DL 171 Nanoose District Plan VIP71158 that fronts the Island Highway.

¹ Bylaw No. 500.291, adopted June 10, 2003

**ENGLISHMAN RIVER (BLOCK 564)
COMPREHENSIVE DEVELOPMENT ZONE 14 continued**

3.4.112.2 Maximum Number and Size of Buildings and Structures

Accessory buildings	Combined floor area 400 m ²
Dwelling units/parcel	1
Height of buildings	9.0 m
Parcel coverage	10%

3.4.112.3 Minimum Setback Requirements

Watercourse	30.0 metres
Top of the bank adjacent to a watercourse	15.0 metres
All other lot lines	8.0 metres

Where the top of the bank adjacent to a watercourse is within 30.0 metres of the natural boundary of a watercourse then the setback shall be a minimum of 30.0 metres from the natural boundary of the watercourse or 15.0 metres from the top of the bank, whichever is greater.

3.4.112.4 Minimum Parcel Size

- | | |
|--|--------|
| a) for a parcel with a connection to a community water system | 1.0 ha |
| b) for a parcel without a connection to a community water system or community sewer system | 8.0 ha |
-

3.4.112.5 Other Regulations

For the purpose of this zone:

- a) Where land in this zone is not within the ALR, the keeping of animals, as set out in section 3.3.5 of this bylaw is further restricted to a maximum of 2 livestock animals that may be kept on a parcel at the same time except that no livestock shall be kept on those parcels that front the public lands adjacent to the Englishman River and South Englishman River.
- b) Home Based Business Use - the regulations set out in section 3.3.14 applicable to the Rural 5 zone apply to this zone.

**ENGLISHMAN RIVER (BLOCK 564)
COMPREHENSIVE DEVELOPMENT ZONE 14 continued**

3.4.112.6 Community Water System Standards Applicable to this zone.

For the purpose of this zone:

- a) The design population to be used in calculating water demand as referred to in section 2.3 of Schedule 4C of this bylaw shall be 553 persons.
- b) The water supply quality as referred to in section 2.5 of Schedule 4C of this bylaw shall meet or exceed both potable and aesthetic standards according to the current Canadian Drinking Water Standard.
- c) The ground water supply source as referred to in section 2.6 of Schedule 4C of this bylaw shall provide for a minimum demand of 100 imperial gallons per minute developed in accordance with the specifications and testing procedures of Schedule 4C of this bylaw.
- d) The reservoir size for water storage as referred to in section 2.7 (1) of Schedule 4C of this bylaw shall be a minimum of 150,000 imperial gallons and may be located outside the CD14 zone provided the site area of the reservoir and access to the site is secured by statutory right-of-way.
- e) The standard for fire hydrant distribution, as referred to in section 2.10 of Schedule 4C of this bylaw, shall be the spacing of fire hydrants such that the maximum distance from a hydrant to the centroid of any parcel measured along the centreline of the highway and perpendicular to a highway, is 300 metres.
- f) No community wells shall produce less than 30 imperial gallons per minute.

Comprehensive Development Zone CD14 Schedule 2

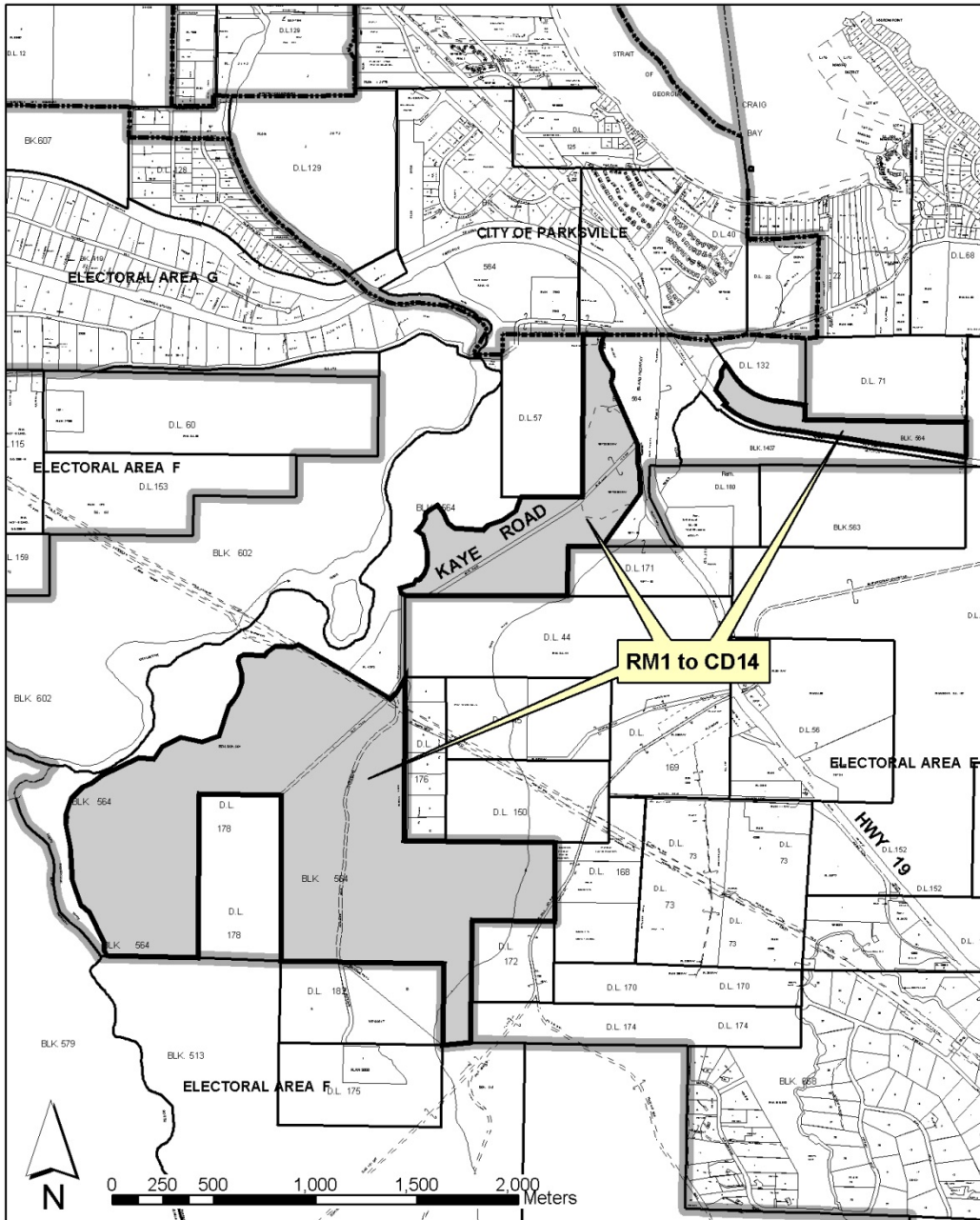

**Comprehensive Development Zone CD14
Schedule 3**

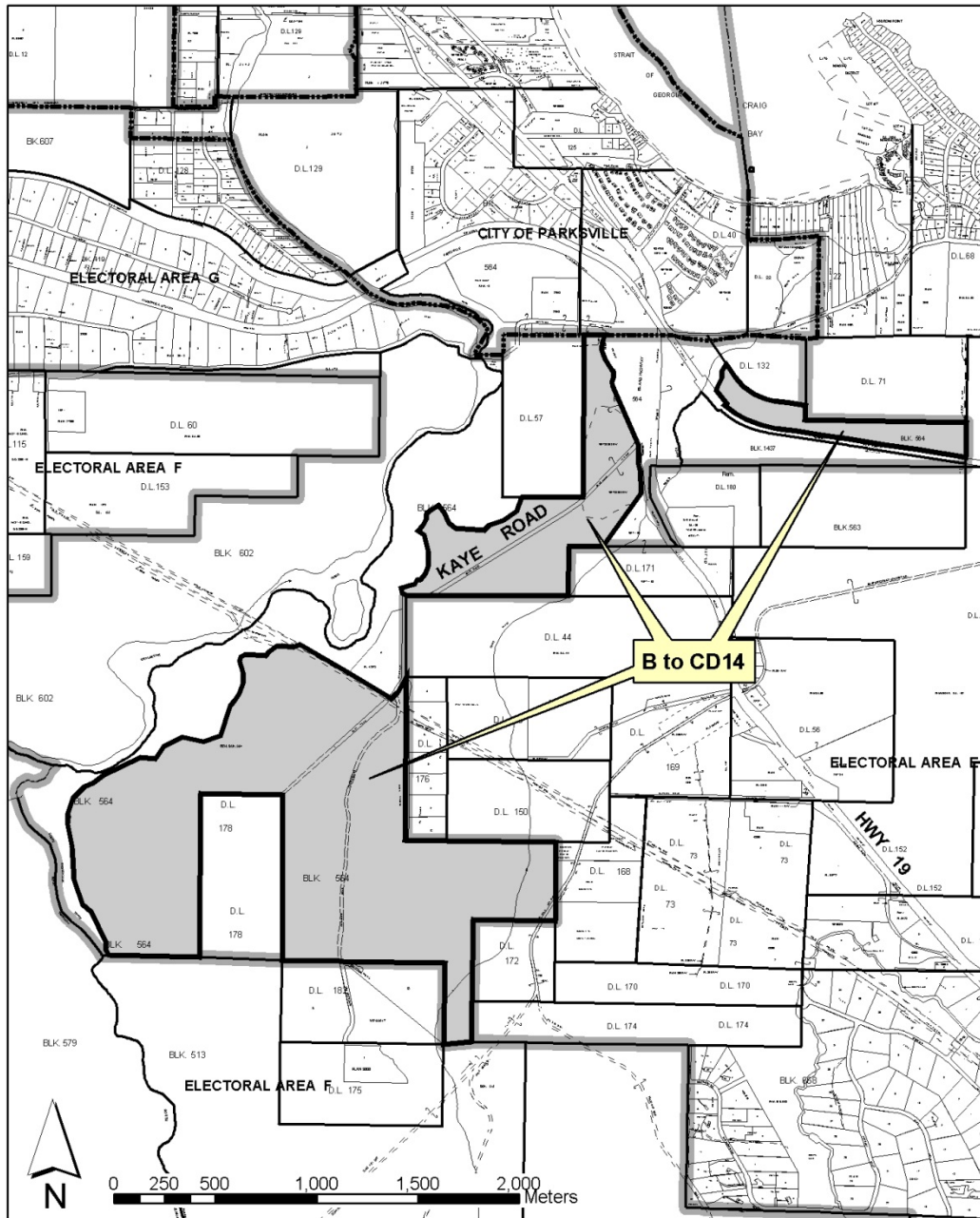

Section 3.4.113

**KIPP ROAD INDUSTRIAL
COMPREHENSIVE DEVELOPMENT ZONE 15**

CD15¹

3.4.113.1 Permitted Uses, Density, and Park Amenity

Permitted Uses

- a) Light Industry Use
- b) Manufacturing Use
- c) Marshalling Yard
- d) Residential Use

3.4.113.2 Maximum Number and Size of Buildings and Structures

Accessory manufacturing office	Combined floor area 400 m ²
Dwelling units/parcel	1
Height of buildings	8.0 m
Parcel coverage	40%

3.4.113.3 Minimum Setback Requirements

All lot lines	8.0 metres
---------------	------------

3.4.113.4 Other Regulations

For the purpose of this zone:

- a) Manufacturing use means the assembling and manufacturing of a product or products taking place within a building and shall include an accessory office use.
- b) The maximum permitted site area for a marshaling yard use shall not exceed 4000 m².
- c) The maximum permitted site area for an outdoor storage use shall not exceed 3500 m² and is limited to one area of the site.
- d) Outdoor storage use shall not include any vehicles, industrial equipment, mobile homes, boats, recreational vehicles, or other similar vehicle or equipment, which may negatively impact groundwater.
- e) The accessory commercial washing of vehicles associated with a marshaling yard use is not permitted unless an approved water recycling/oil separator system is in operation.
- f) All manufacturing shall be contained within a building or buildings other than the assembly of products limited to 65 m² in area and provided that there is no outdoor storage of products.
- g) There shall be no outdoor sandblasting permitted within this zone.
- h) There shall be no outdoor tire storage permitted within this zone.

¹ Bylaw No. 500.299, adopted July 13, 2004

Comprehensive Development Zone CD15 Schedule 2

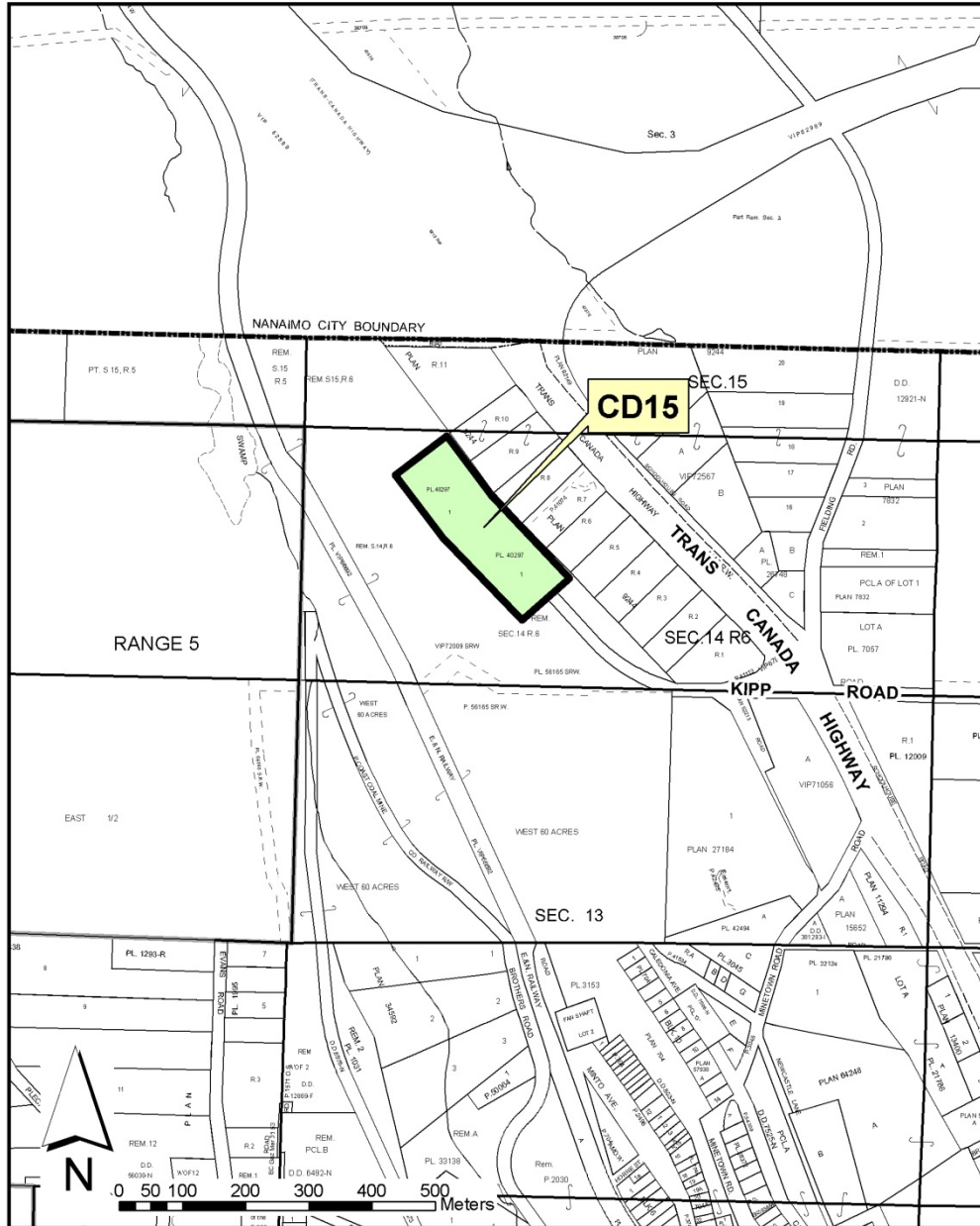

BCGS MAPSHEET NO. 92G.011.1.2

Comprehensive Development Zone CD15 Schedule 3

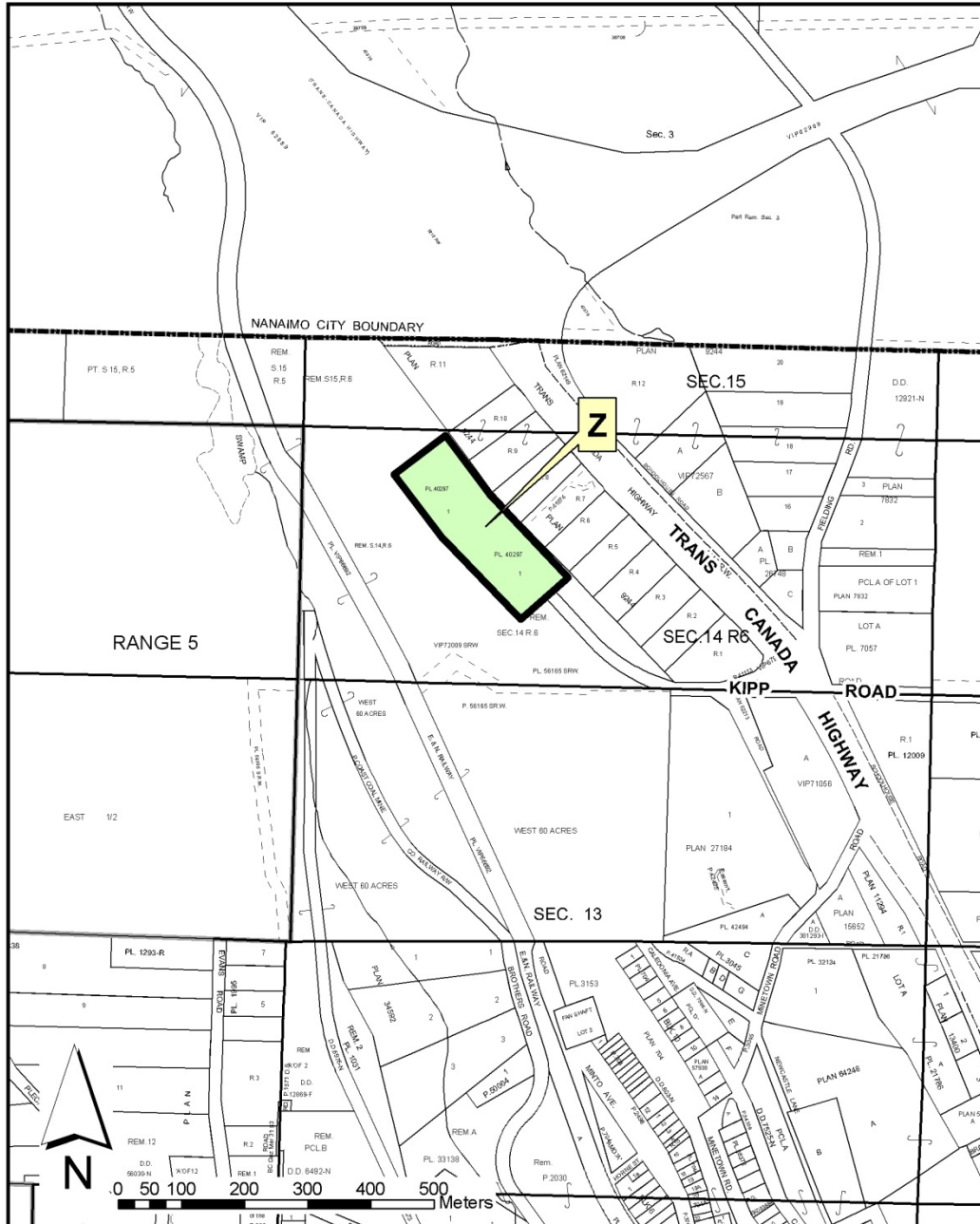

BCGS MAPSHEET NO. 92G.011.1.2

Section 3.4.117

COMPREHENSIVE DEVELOPMENT ZONE 17

CD17¹

3.4.117.1 Permitted Uses and Density

Permitted Uses

- a) Public Utility Use
 - b) Residential use
-

3.4.117.2 Maximum Number and Size of Buildings and Structures

Dwelling units/parcel	1
Height of buildings	10.0 m
Parcel coverage	50%

3.4.117.3 Minimum Setback Requirements

All lot lines	5.0 metres
---------------	------------

¹ Bylaw No. 500.300, adopted October 26, 2004

Comprehensive Development Zone CD17 Schedule 2



BCGS MAPSHEET 92G.001.4.4.

Comprehensive Development Zone CD17 Schedule 3



BCGS MAPSHEET 92G.001.4.4.

Section 3.4.118

**SCHOOLHOUSE ROAD LIGHT INDUSTRIAL
COMPREHENSIVE DEVELOPMENT ZONE 18**

CD18¹

3.4.118.1 Permitted Uses and Density

Permitted Uses

- a) Industrial Equipment Display Use
 - b) Light Industry
 - c) Residential Use
-

3.4.118.2 Maximum Number and Size of Buildings and Structures

Dwelling units/parcel	1
Height of buildings	8.0 m
Parcel coverage	40%

3.4.118.3 Minimum Setback Requirements

Lot lines adjacent to Schoolhouse Road	8.0 metres
All other lot lines	5.0 metres

3.4.118.4 Other Regulations

For the purpose of this zone:

- a) *Industrial Equipment* Display Use means the use of land, buildings or structures for the display, sale or rental of industrial vehicles and includes the servicing of such equipment.

¹ Bylaw No. 500.301, adopted September 28, 2004

Comprehensive Development Zone CD18 Schedule 2

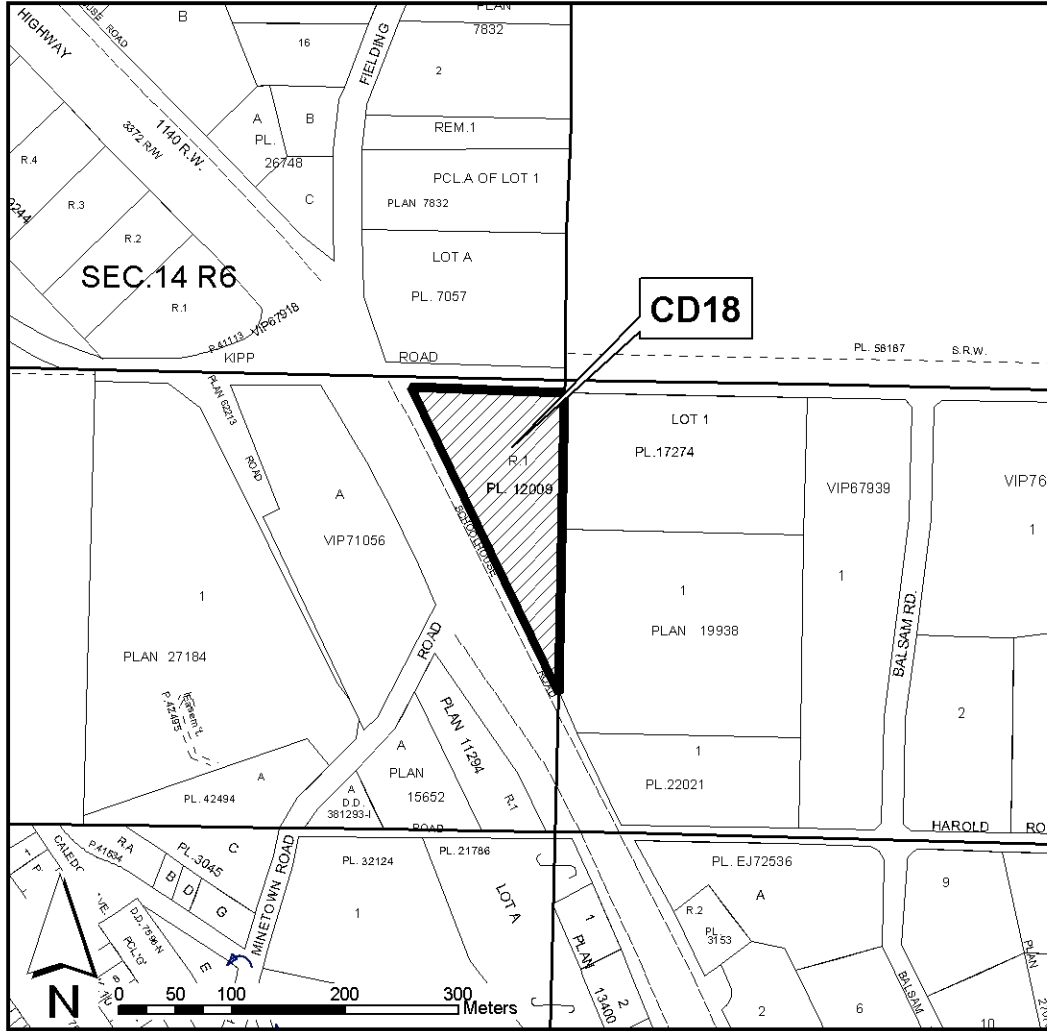

BCGS MAPSHEET NO. 92G.0112.1

Comprehensive Development Zone CD18 Schedule 3

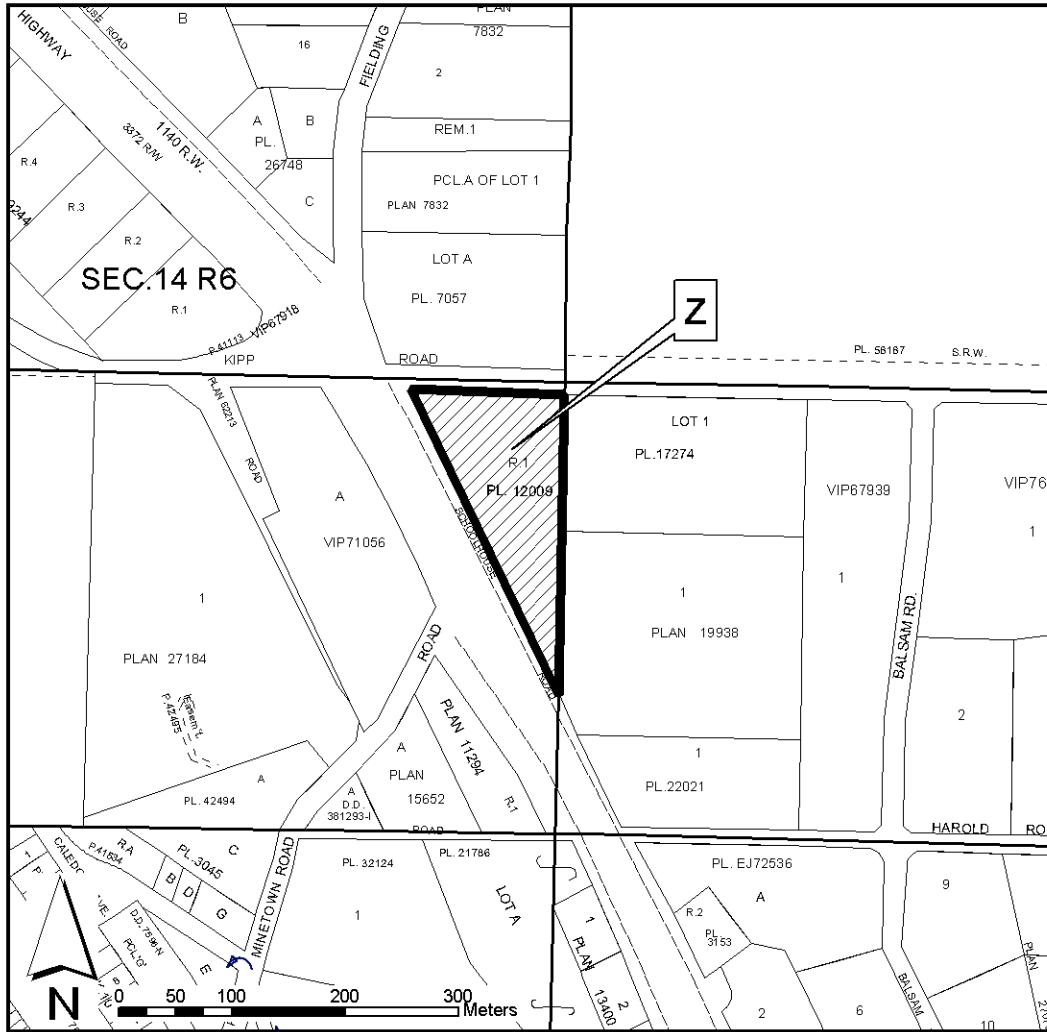

BC/GS MAPSHEET NO. 92G.0112.1

Section 3.4.119

**MIDORA ROAD
COMPREHENSIVE DEVELOPMENT ZONE 19**

CD19¹

3.4.119.1 Permitted Uses and Density

Permitted Uses

- a) Residential Use
 - b) Home Based Business
-

3.4.119.2 Maximum Number and Size of Buildings and Structures

Accessory Building	250 m ²
Height	9.0 m
Parcel coverage	25%
Dwelling Units/Parcel	1

3.4.119.3 Minimum Parcel Size

2.0 ha

Despite the minimum parcel size, residential parcels may be averaged based on the total size of the parent parcel divided by the number of residential parcels created provided that the total number of residential parcels not exceed 9 and that no residential parcel is less than 0.5 hectares.

3.4.119.4 Minimum Setback Requirements

All buildings and structures:

All lot lines 8.0 metres

Except where any part of a parcel is adjacent to or contains a watercourse then the regulations in Section 3.3.8 shall apply.

¹ Bylaw No. 500.308, adopted February 28, 2006

**Comprehensive Development Zone CD19
Schedule 2**

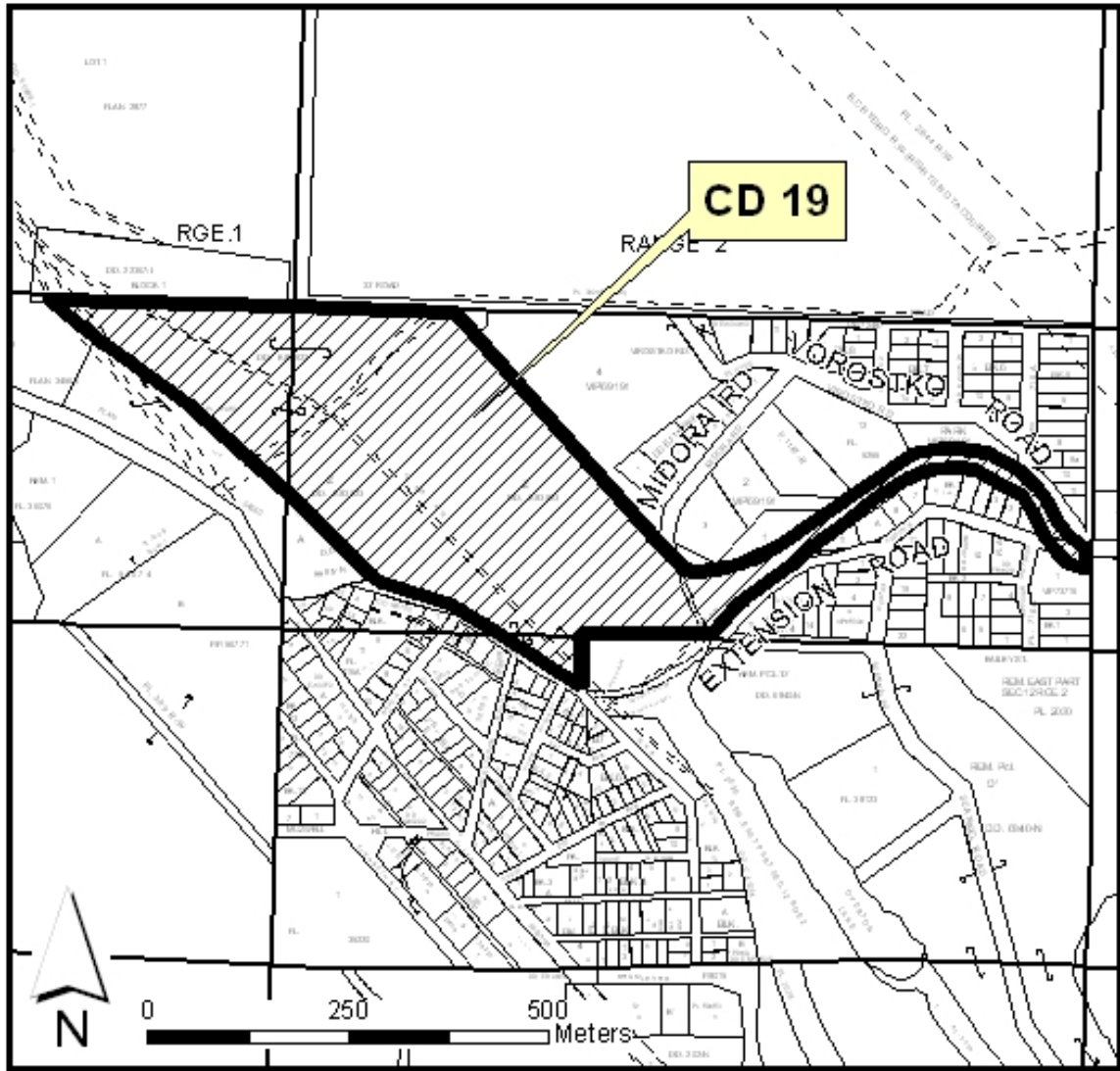

BCGS Map Sheet No. 92G.011.1.1

Section 3.4.120

**PARKLANDS MOBILE HOME PARK
COMPREHENSIVE DEVELOPMENT ZONE 20 *Dist of Lantz**

CD20¹

3.4.120.1 Permitted Uses and Density

Permitted Uses

- a) Residential Use
 - b) Accessory buildings and structures for each mobile home and the Mobile Home Park
-

3.4.120.2 Maximum Number and Size of Buildings and Structures

The maximum number of dwelling units shall be:

- i) 29 Mobile homes and 6 RV sites
- ii) Mobile homes shall not exceed a maximum footprint width of 4.5 metres except that 5 mobile homes may have a maximum footprint width of 7.5 metres

The maximum number of accessory buildings shall be:

- i) 1 accessory building per mobile home not exceeding a floor area of 10 m²
- ii) Mobile home accessory building height shall not exceed 3.0 metres
- iii) Common accessory buildings shall not exceed a combined maximum floor area of 200 m²
- iv) Common accessory buildings height shall not exceed 6.0 metres

The maximum number of porch/deck additions shall be:

- i) 1 porch/deck addition per mobile home not exceeding a floor area of 20 m² excluding wheel chair ramps
 - ii) 1 entrance stairs to a secondary access not exceeding a floor area of 2 m²
-

3.4.120.3 Minimum Setback Requirements

- a) All buildings and structures
 - Exterior lot line 5.0 metres
 - Interior lot line 2.0 metres
- b) Except where any part of a parcel is adjacent to or contains a watercourse then the regulations in Section 3.3.8 shall apply.
- c) All buildings/ structures or mobile homes – 3.0 metres from adjacent mobile home or building/structure

¹ Bylaw No.500.311, adopted June 13, 2005

COMPREHENSIVE DEVELOPMENT ZONE 20 continued

3.4.120.4 Other Regulations

For the purpose of this zone:

- a) Mobile Homes
 - i) No new additions shall be constructed for habitable space
 - ii) No carports or enclosed garages are permitted
 - iii) Any porch/deck or entrance addition shall be structurally supported Independent of the mobile home and shall have a building permit.
- b) Recreational Vehicles shall
 - i) Be licensed and have wheels
 - ii) Have no structural skirting
 - iii) Have no structural decks or additions
- c) Porch is defined as a structure abutting a mobile home having a roof but with walls that are open and unenclosed to the extent of at least 50% thereof and is constructed on piers or a foundation above grade for use as an outdoor living area
- d) Deck is defined as a structure abutting a mobile home with no roof or walls except for visual partitions and railings and is constructed on piers or a foundation above grade for use as an outdoor living area

Section 3.4.121

COMPREHENSIVE DEVELOPMENT ZONE 21

CD21¹

3.4.121.1 Permitted Uses and Density

Permitted Uses

- a) Agriculture
 - b) Aquaculture
 - c) Home Based Business
 - d) Produce Stand
 - e) Residential Use
 - f) Silviculture
 - g) Soil Processing
-

3.4.121.2 Maximum Number and Size of Buildings and Structures

Accessory Buildings	Combined floor area of 400m ²
Dwelling units/parcel	a) on a parcel having an area of 2.0 ha or less - 1 b) on a parcel having an area of greater than 2.0 ha - 2
Height of buildings	9.0 m
Parcel coverage	25%

3.4.121.3 Minimum Setback Requirements

Buildings and structures for housing livestock or for storing manure – all lot lines	30.0 metres
All other buildings and structures – all lot lines	8.0 metres

Except where:

- a) The parcel is less than 4000m² in area then the setback from lot lines may be reduced to 2.0m from an interior side lot line and to 5.0 m from other lot lines, excluding the front lot line;
 - b) Any part of a parcel is adjacent to or contains a watercourse then the regulations in Section 3.3.8 shall apply
-

3.4.121.4 Other Regulations

For the purpose of this zone:

Soil Processing means the use of 0.1 ha of land for the mixing, screening and storage of soil and pre-chipped wood waste, for commercial use off the property, and excludes commercial composting for off site use.

¹ Bylaw 500.310, adopted May 9, 2005

Comprehensive Development Zone CD21 Schedule 2

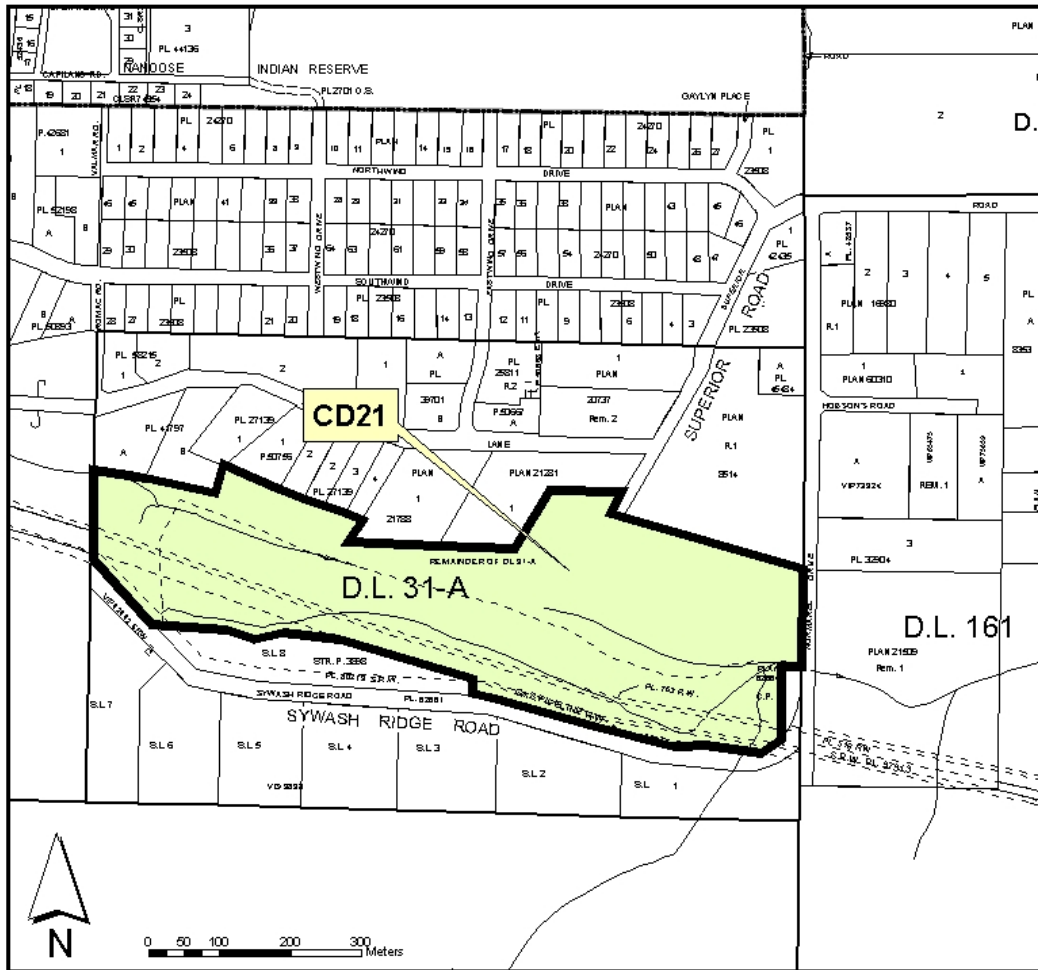

BOGS MAPSHEET NO. 92F.030.1.4

Section 3.4.124¹

**HORNE LAKE REGIONAL PARK
COMPREHENSIVE DEVELOPMENT ZONE 24**

CD24

3.4.124.1 Permitted Uses and Density

Permitted Uses

- a) Wilderness Campground
 - b) Outdoor Wilderness Recreation
 - c) Tourist Accommodation
 - d) Day Use Recreation
 - e) Group Camping
 - f) Public Assembly
-

3.4.124.2 Permitted Accessory Uses

- a) Accessory Office, Building and Structures
 - b) Boat Ramp
 - c) Residential Use
 - d) Tourist Store
 - e) Visitor Centre
-

3.4.124.3 Maximum Number and Size of Buildings and Structures

- a) Wilderness Campground Maximum of 125 individual camp sites and a maximum of seventy five (75) camping parties within three (3) group camping areas subject to subsections 3.4.124.4 and 3.4.124.6 to 3.4.124.8
- b) Tourist Accommodation Maximum 10 units and shall not exceed 35m² in floor area per unit excluding a 7.5 m² deck
- c) Dwelling Units /Parcel 1
- d) Dwelling Unit Height 8.0 m as measured above the flood construction elevation pursuant to subsection 3.4.124.5
- e) Accessory Buildings Combined floor area of 500 m²
Accessory horse boarding stable – maximum of 10 stalls not exceeding 5 m² in floor area per stall
Tourist Store shall not exceed 20 m² in floor area.
- f) Accessory Building/
Structure Height 8.0 m as measured above the flood construction elevation pursuant to subsection 3.4.124.5 except for zip line
- g) Parcel Coverage 30%

¹ Bylaw No. 500.318, adopted September 20, 2005

**HORNE LAKE REGIONAL PARK
COMPREHENSIVE DEVELOPMENT ZONE 24 continued**

3.4.124.4 Minimum Setback Requirements

- a) Buildings and structures for housing livestock or for storing manure
 - i) All lot lines 30.0 metre
 - ii) Horne Lake 30.0 metre natural boundary
 - iii) Qualicum River 30.0 metre natural boundary
 - iv) Internal access roads 3.0 metre
- b) All other buildings, structures, camp sites, campground services (internal roads, parking, water, and waste disposal systems)
 - i) All lot lines 8.0 metre
 - ii) Horne Lake 30.0 metre natural boundary
 - iii) Qualicum River 30.0 metre natural boundary

3.4.124.5 Flood Control

- a) The following lands are designated flood plain:
 - i) Block 40, Alberni District, Plan 691N, except that part thereof shown outlined in red on Plan 1339R and except that part in Plan 46603
 - ii) Part of Block 40, Alberni District, Plan 1339R
- b) The flood construction elevation shall be 121.7 metres Geodetic Survey of Canada for any permanent building.

3.4.124.6 Campground Layout Standards

- a) Individual Camp Sites
 - i) Every camp site shall have a minimum area of not less than 110m².
 - ii) Every camp site shall have a maximum slope of five percent.
 - iii) No camp site shall be located within:
 - 01. 3.0 m of another camp site; and
 - 02. the setback areas established pursuant to Part 3.4.124.4 of this Bylaw.
 - iv) Each individual camp site shall have one conveniently located parking space adjacent to the internal access road and may be sited in the area allotted for the 3.0 m internal road access setback.
 - v) No recreation vehicle or tent shall be located elsewhere in a campground than on a camp site or group camp site.
 - vi) No more than one camping party shall be permitted in one camp site.
- b) Group Camp Area
 - i) A maximum of 3 group camping areas with a combined area of 3.0 ha is permitted.
 - ii) A maximum of 75 camping parties are permitted in the 3 group camping areas.
 - iii) A maximum of 2 vehicles per camping party may park within the group camping area.

**HORNE LAKE REGIONAL PARK
COMPREHENSIVE DEVELOPMENT ZONE 24 continued**

- iv) Each group camp area shall have a minimum of a 5 m wide vegetated buffer.
 - v) Each group camping area shall have a centralized fire pit.
 - vi) Each group camp area shall have a maximum slope of five percent.
 - vii) No recreation vehicle or tent shall be located elsewhere in a campground than on a group camp site.
 - viii) No group camp site shall be located within:
 - 01. 3.0 m of another camp site; and
 - 02. the setback areas established pursuant to Part 3.4.124.4 of this Bylaw.
- c) Buffer Area
- i) Day use recreation is permitted within the setback pursuant to subsection 3.4.124.4b. ii.
- e) Internal Access Roads
- i) All internal access roads shall be of hard durable surface so as not to produce dust.
 - ii) The minimum internal access road width shall be 6.0 metres
 - iii) Dead-end internal access roads and cul-de-sacs shall have a turning radius of 12.0 metres.
- f) Group, Day Use and Trailer Parking
- i) These requirements do not apply to parking spaces pursuant to 3.4.124.6.a.iv and 3.4.124.6.b.iii
 - ii) A minimum of 100 parking spaces shall be provided.
 - iii) Parking stall and aisle dimensions shall be in accordance with Schedule '3B' Table 2 of this Bylaw.
 - iv) A minimum of 10 disability parking spaces shall be provided.
 - v) Each disability space shall be:
 - 01. a minimum of 4.0 metres wide
 - 02. marked with the International Symbol of Accessibility
 - 03. located adjacent to the day use area within convenient access of the development, building, or use that it is intended to serve, and any level change shall not exceed 13 mm
 - vi) A minimum of 50 boat trailer parking spaces shall be provided for boat launch patrons once the number of camping parties exceeds 100. Each boat trailer parking space shall:
 - 01. enable the vehicle to pull thru; and
 - 02. be a minimum length of 11 m.
 - vii) All parking spaces shall be clearly delineated.
 - viii) All parking spaces shall be provided and maintained with a hard durable surface that does not produce dust and is permeable.
 - ix) All parking spaces shall have a maximum gradient and cross-slope of 6%.

**HORNE LAKE REGIONAL PARK
COMPREHENSIVE DEVELOPMENT ZONE 24 continued**

3.4.124.7 Campground Servicing

- a) Washroom Facilities:
 - i) Shall be located in a separate building(s); and
 - ii) Shall be located:
 - 01. a maximum of 150 m from any individual camp site or group camping area;
 - 02. a minimum of 4.5 m from any camp site;
 - 03. a minimum of 15 m from any drinking water source or surface water;
 - 04. a minimum of 3 m from any building, internal access road or water supply pipe, and
 - iii) Shall be established as outlined in Table No. 1; and
 - iv) Where holding tanks are utilized for toilets they shall be sealed and have a minimum capacity 200 gal.
 - v) A minimum of 2 toilets (1 male and 1 female) shall be wheelchair accessible and located adjacent to the primary day use area.
 - vi) A minimum of 2 wash basins and 2 shower (1 male and 1 female) shall be wheelchair accessible.

Table No. 1

Number of potential camping parties	Toilets		Wash basins		Showers	
	Female	Male	Female	Male	Female	Male
1 - 75	10	10	0	0	0	0
76 – 120	12	12	2	2	2	2
121 – 200	14	14	4	4	6	6

- b) Sewage Disposal Station (Sani-dump)

One sewage disposal station for use by recreational vehicles shall:

 - i) be established once the number of potential camping parties exceeds 100
 - ii) be located:
 - 01. in the North park ;
 - 02. a maximum of 150 m from any individual camp site or group camping area;
 - 03. a minimum of 4.5 m from any camp site;
 - 04. a minimum of 15 m from any drinking water source or surface water; and
 - 05. a minimum of 3 m from any building, internal access road or water supply pipe.
- c) Water System

Potable water source shall be provided once the number of potential camping parties exceeds 75.
- d) Garbage Disposal and Recycling
 - i) Large communal garbage and recycling facilities shall be centrally located in the North and South Park;
 - ii) Small garbage and recycling receptacles shall be located in all day use areas; and
 - iii) All garbage and recycling facilities and receptacles shall be animal and insect proof.

**HORNE LAKE REGIONAL PARK
COMPREHENSIVE DEVELOPMENT ZONE 24 continued**

3.4.124.8 Other Regulations

For the purpose of this zone:

- i) “Adventure Camp” means an outdoor wilderness recreation program area including one group camping area.
- ii) “Camp site (Individual)” means an area within a campground used by one camping party for tents or recreational vehicles.
- iii) “Camping Party” means a maximum of eight (8) persons including no more than four (4) adults, an adult being a person 16 years of age or over.
- iv) “Day Use Recreation” means an area consisting of largely of open space, which may include picnic area, playground, gazebo, docks and wharves, or similar use but shall not include a campground.
- v) “Group Camping Area” means an area used for camping by three or more camping parties and shall include the Adventure Camp.
- vi) “Outdoor Wilderness Recreation” means a recreational activity undertaken where the outdoor setting and natural landscape is a significant element in the activity, where there is no significant alteration of the land, where there is no hydro service, and the density of recreational users is not a significant element and includes obstacle course, zip line course, orienteering, horse boarding and trail rides, trails, day use recreation.
- vii) “Temporary accommodation” means the occupation of a camp site to a maximum of 28 days in total per year by any one camping party.
- viii) “Tourist accommodation” means a one-storey building with a heat source and with no provision for cooking, sanitation or permanent residential occupancy.
- ix) “Tourist Store” means a detached accessory building or portion of an accessory building that sells supplies and pre-packaged dry goods catering to park users and specifically prohibits the preparation of food.
- x) “Visitor Centre” means a place in a fully enclosed building for the purposes of viewing or displaying information and exhibits related to natural and cultural history, the natural environment, and wilderness recreation, and where such display is intended, in part, to serve the educational and cultural needs of the community as a whole.
- xi) “Washroom facilities” means a building or buildings that contain toilets, washbasins, and heated showers.
- xii) “Wilderness campground” means an area in Horne Lake Regional Park without hydro service that provides for the temporary accommodation of travellers using tents, tent trailers, or recreational vehicles and specifically excludes a mobile home park or hotel

Comprehensive Development Zone CD24 Schedule 2

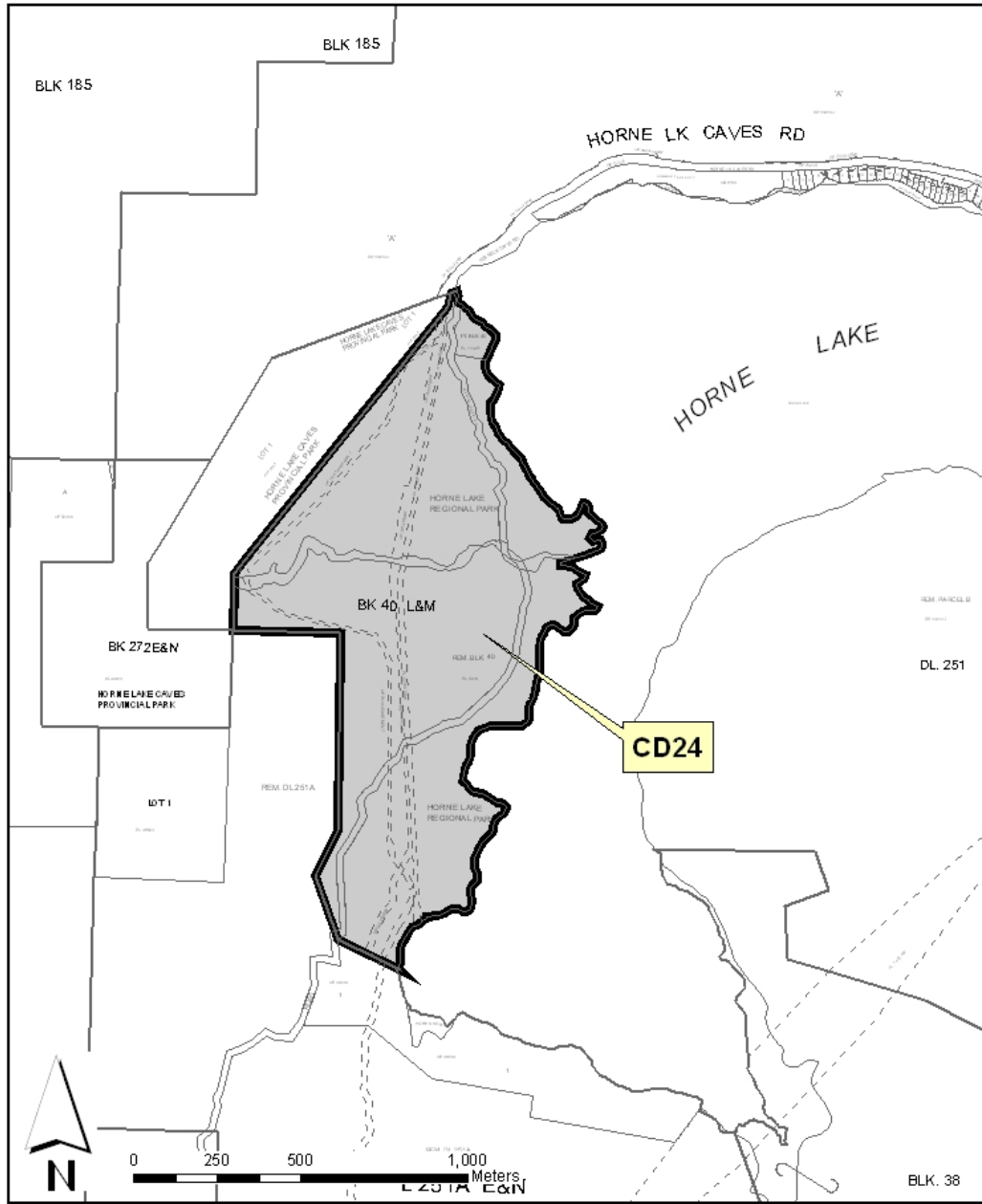

Comprehensive Development Zone CD24
Schedule 3

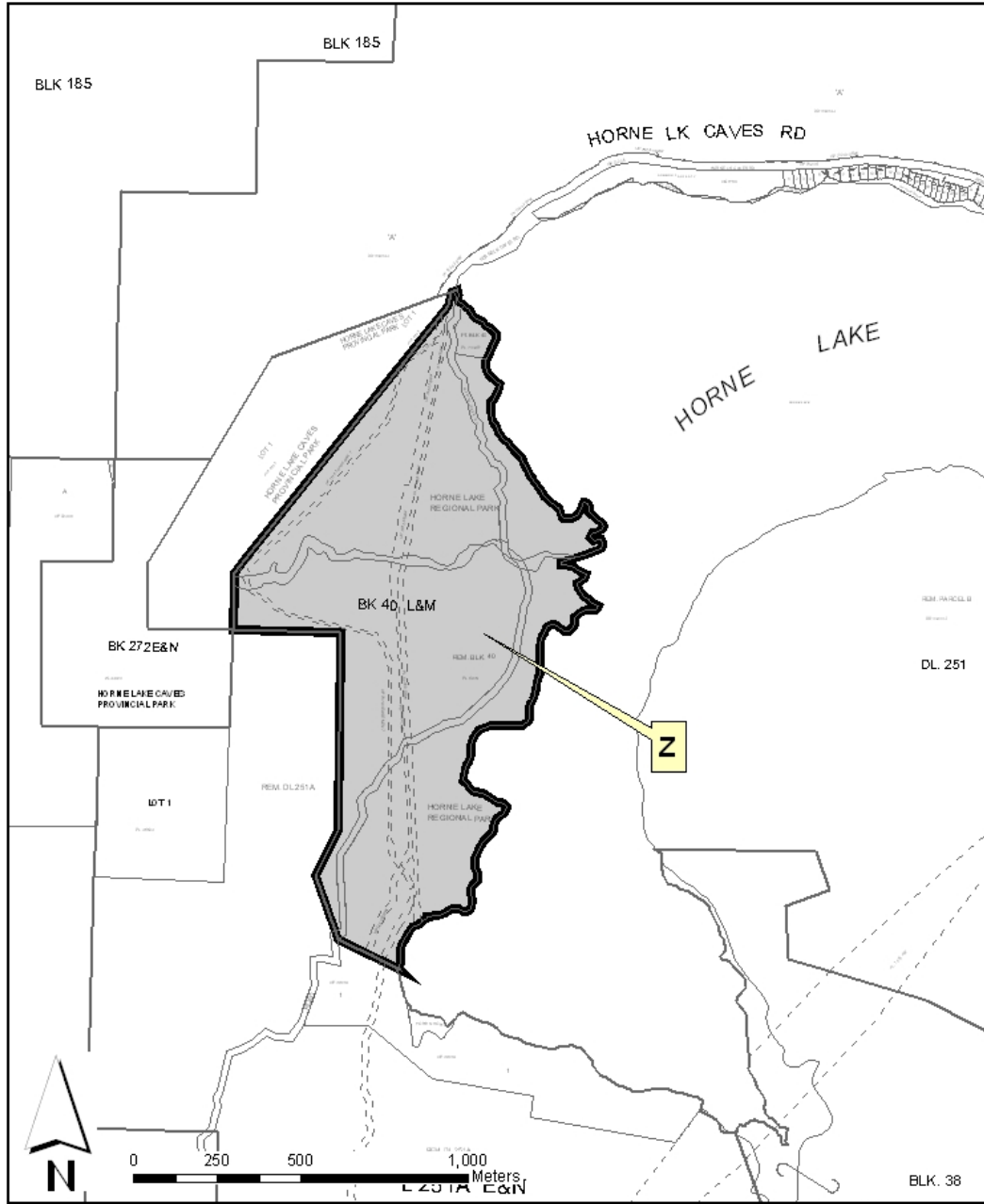

Section 3.4.126

**CLAUDET ROAD RURAL COMPREHENSIVE
DEVELOPMENT ZONE 26**

CD261

3.4.126.1 Permitted Uses, Density and Park Amenity

Permitted Uses

- a) Agriculture
 - b) Home Based Business
 - c) Residential Use
-

3.4.126.2 Maximum Number and Size of Buildings and Structures

Accessory Buildings	Combined floor area of 400m ²
Dwelling units/parcel	1
Height	9.0 m
Parcel coverage	25%

3.4.126.3 Minimum Setback Requirements

Buildings and structures for housing livestock or for storing manure:

All lot lines	30.0 metres
All other buildings and structures – all lot lines	8.0 metres

Except where any part of a parcel is adjacent to or contains a watercourse then the regulations in section 3.3.8 apply.

3.4.126.4 Minimum Parcel Size

Minimum parcel size 4.0 ha

Despite the minimum parcel size, a maximum of 1 rural parcel may be parcel averaged based on the total size of the parent parcel divided by the number of rural parcels created provided that the total number of rural parcels does not exceed 2 and 1 rural parcel is not less than 1.4 ha in size.

3.4.126.5 Other Regulations

For the purpose of this zone:

- a) Intensive Agricultural Uses including feed lot, fur farm, mushroom farm, horse boarding stable, and intensive swine operation are not permitted in this zone.
- b) Home based business – the regulations set out in section 3.3.14 applicable to the Rural 5 zone apply to this zone.

¹ Bylaw No. 500.309, adopted January 24, 2006

Comprehensive Development Zone CD26 Schedule 2

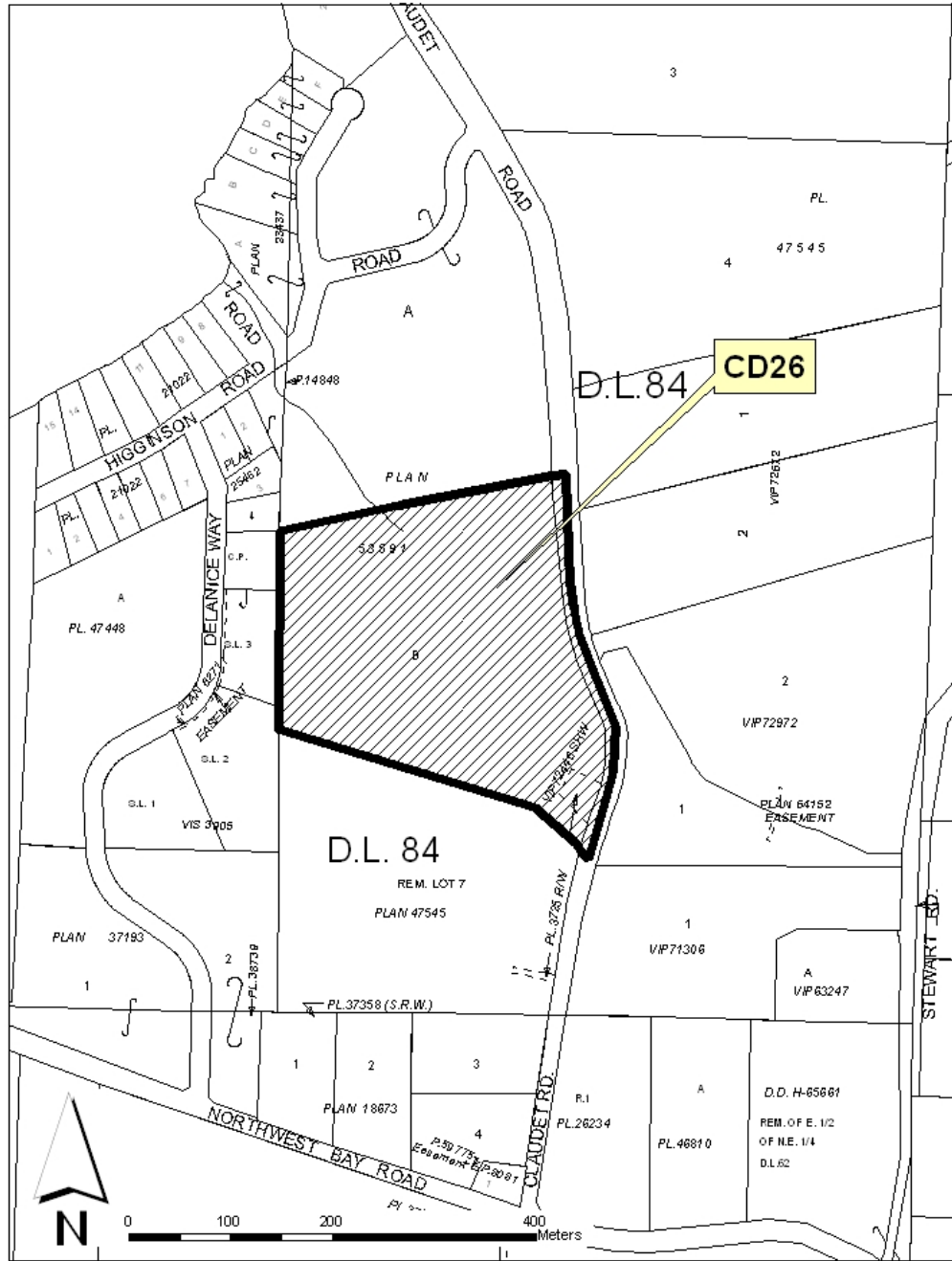

BCGS Map Sheet No. 92F.030.3.3

Comprehensive Development Zone CD26
Schedule 3

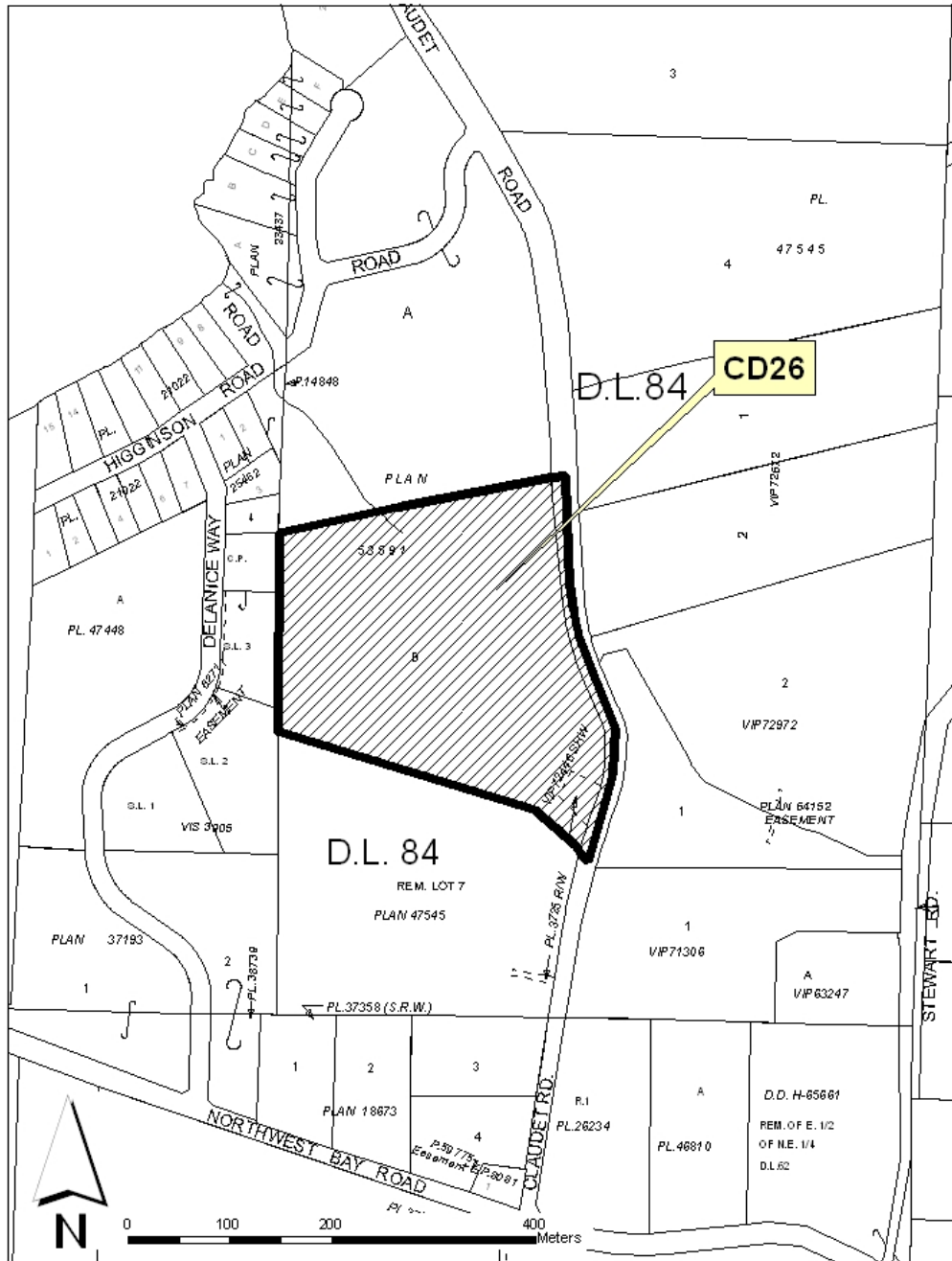

BCGS Map Sheet No. 92F.030.3.3

Section 3.4.128

**SOUTH WELLINGTON LIGHT INDUSTRIAL
COMPREHENSIVE DEVELOPMENT ZONE 28**

CD28¹

3.4.128.1 Permitted Uses

Permitted Uses

Light Industry
Manufacturing Use
Recreational Vehicle Sales and Storage
Residential Use
Moving Truck and Moving Trailer Rentals

3.4.128.2 Maximum Number and Size of Buildings and Structures

Dwelling units/parcel	1
Height of buildings	8.0 m
Parcel coverage	60%

3.4.128.3 Minimum Parcel Size:

1.0 hectare

3.4.128.4 Minimum Setback Requirements

Front Lot Line	8.0 metres
Other Lot Lines	5.0 metres

3.4.128.5 Regulation of Signs

- a) Within this zone, a maximum of two (2) freestanding signs shall be permitted adjacent to the Trans Canada Highway and one (1) freestanding entrance sign shall be permitted adjacent to South Wellington Road.
- b) No freestanding sign adjacent to the Trans Canada Highway shall exceed a maximum width of 5.5 metres or height of 6.1 metres as measured from natural grade.
- c) The combined sign surface area of all sides of all freestanding signs adjacent to the Trans Canada Highway shall not exceed 35.3 m².
- d) The freestanding entrance sign permitted adjacent to South Wellington Road shall not exceed a height nor width of 5.0 metres and the combined sign surface area of all sides shall not exceed 11.0 m².
- e) One fascia sign not exceeding twenty five percent (25%) of each tenant's store front shall be permitted and each fascia sign shall not exceed a maximum sign face area of 7.0 m².
- f) No additional freestanding signs shall be permitted.
- g) The use of banners, ribbons, flags, on-site display props, streamers, pennants, or mobile signs are prohibited.
- h) Signs may be illuminated internally or externally and the use of neon lighting, or blinking or flashing lights is prohibited.

¹ Bylaw No. 500.327, adopted July 25, 2006

**SOUTH WELLINGTON LIGHT INDUSTRIAL
COMPREHENSIVE DEVELOPMENT ZONE 28 continued**

3.4.128.6 Other Regulations

For the purpose of this zone:

- a) *Manufacturing Use* means the assembling and manufacturing of a product or products in a building only and may include indoor accessory retail sales of the product(s) produced to a maximum of ten percent (10%) of the floor area of the building and may include an accessory office use.
- b) *Recreational Vehicle Sales or Storage* means the use of land or buildings for the sale or storage of recreational vehicles to a maximum of ten percent (10%) of the area of the parcel and is permitted only in the hatched area as shown in Table No. 1 in Section 3.4.128.7.
- c) *Moving Truck and Moving Trailer Rentals* means the use of land and or buildings for the rental of moving trucks and moving trailers excluding passenger cars and trucks to the general public. The parking of moving trucks and moving trailers is permitted only in hatched area as shown in Table No. 1 in Section 3.4.128.7.
- d) The Recreational Vehicle Sales or Storage area must be clearly separated from the remainder of the parcel and other uses by landscaping and or fencing or combination of the above to create a continuous barrier at least one metre in height, excluding entrances.
- e) The Recreational Vehicle Sales or Storage area must be screened from view along all external property lines with landscaping and or fencing to meet or exceed the following landscaping criteria:
 - i) landscaping shall be provided to the satisfaction of the Regional District of Nanaimo along the perimeter of the Recreational Vehicle Sales and Storage Area, and shall include, a minimum of seventy-five percent (75%) screening from grade level to a height of 3.0 metres and at least twenty-five percent (25%) screening from a height of 3.0 metres to 5.0 metres above grade;
 - ii) provided the overall density of vegetation is provided, landscaping adjacent to Schoolhouse Road may be grouped. No other landscaping on site may be grouped;
 - iii) landscaping shall include planting one evergreen tree for every 3.0 metres of parcel frontage; and
 - iv) all landscaping abutting parking or other vehicle access areas on site shall be protected by a permanent curb a minimum of 15 cm in height to protect landscaping from potential vehicular damage.
- f) The Recreational Vehicle Sales or Storage area and the Moving Truck and Moving Trailer parking area must be clearly separated from the remainder of the parcel and other uses by landscaping and or fencing or combination of the above to create a continuous barrier at least 1.0 metre in height, excluding entrances.
- g) The Moving Truck and Moving Trailer parking area shall be screened from view from South Wellington Road by a vegetated buffer a minimum of 5.0 metres in width.
- h) Except where varied by this zone, landscaping shall be provided in accordance with **Schedule 3F – Landscaping Regulations and Standards of Bylaw No. 500**.
- i) Except for the Recreational Vehicle Sales and Storage and Moving Truck and Moving Trailer Rentals located in the hatched area as shown in Table No. 1 in Section 3.4.128.7, all uses must be fully contained within a building.

Comprehensive Development Zone CD28
Table 1

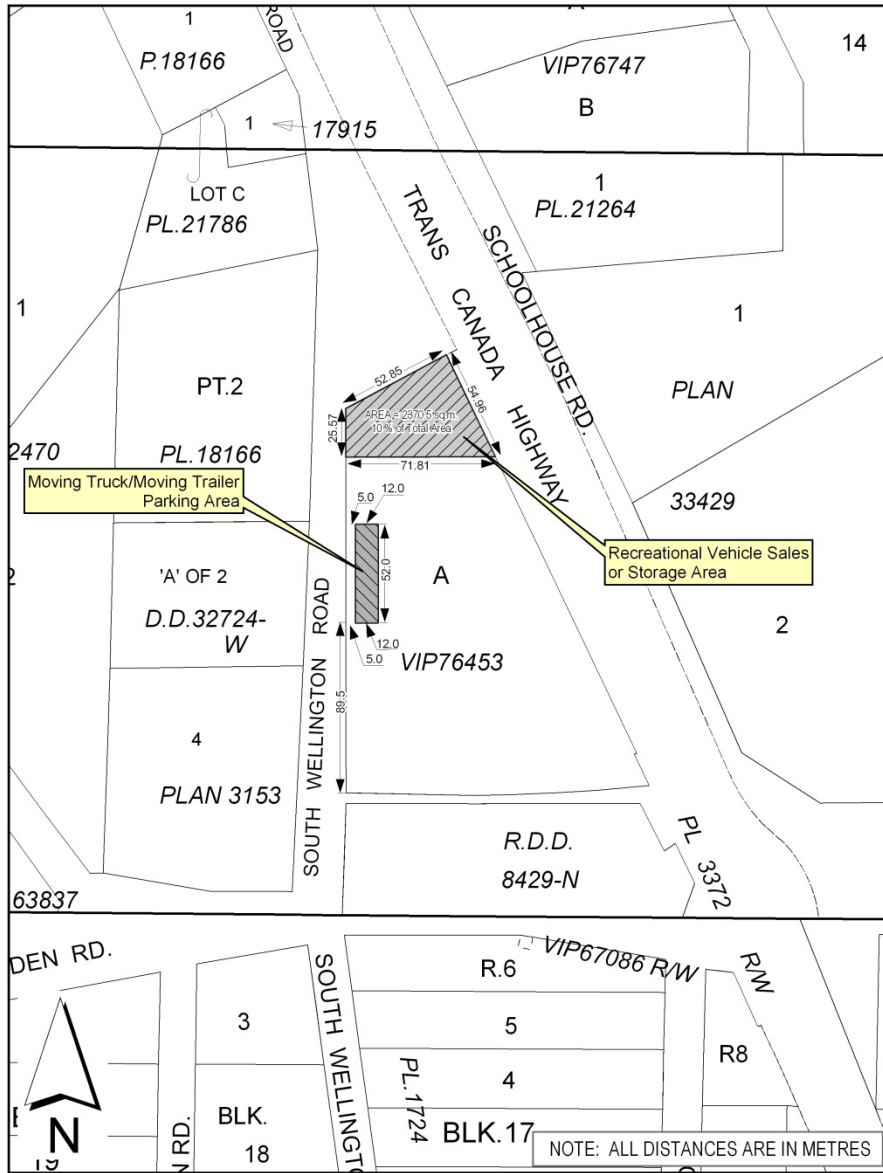

BCGS Map Sheet No. 92G.0014.3

**Comprehensive Development Zone CD28
Table 2**

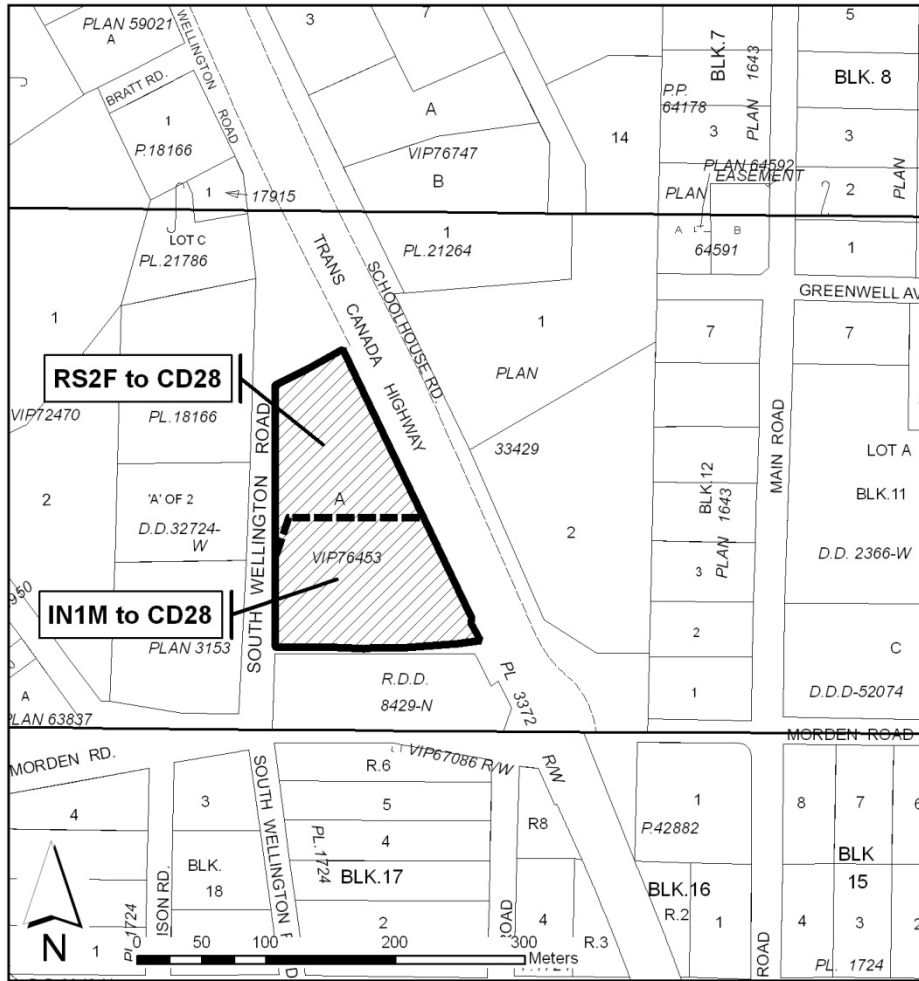

Section 3.4.129

**CEDAR ESTATES COMPREHENSIVE
DEVELOPMENT ZONE 29**

CD29¹

3.4.129a.1 Permitted Uses in Area A as shown in Section 3.4.129d.1

- a) Residential Use
- b) Home Based Business

3.4.129a.2 Maximum Number and Size of Buildings and Structures in Area A

Accessory Buildings	Combined floor area of 100 m ²
Accessory Building Height	5.0 metres
Dwelling Units/parcel	1
Dwelling Unit Height	9.0 metres
Parcel Coverage	40%

3.4.129a.3 Minimum Setback Requirements in Area A

Front Lot Line	6.0 metres
Interior Side Lot Lines	1.5 metres
Rear Lot Lines	3.0 metres
Exterior Lot Lines	4.0 metres

3.4.129a.4 Other Regulations in Area A

For the purpose of this zone:

Minimum Parcel Size:

440 m² with community water and sewer system. No subdivision permitted without full community services.

Parking Requirements:

minimum 2 parking spaces per unit to be developed in accordance with Schedule '3B' of the Bylaw.

Home Based Business uses are restricted to those uses permitted in the RS1 zone for parcels less than 2,000 m² in area.

3.4.129b.1 Permitted Uses in Area B as shown in Section 3.4.129d.1

- a) Residential Use
- b) Home Based Business

¹ Bylaw No. 500.323, adopted July 25, 2006

**CEDAR ESTATES COMPREHENSIVE
DEVELOPMENT ZONE 29 continued**

3.4.129b.2 Maximum Number and Size of Buildings and Structures in Area B

Accessory Buildings	Combined floor area of 150 m ²
Accessory Building Height	9.0 metres
Dwelling Units/parcel	2
Dwelling Unit Height	9.0 metres
Parcel Coverage	40%

3.4.129b.3 Minimum Setback Requirements in Area B

Front Lot Line	6.0 metres
Interior Side & Rear Lot Lines	1.5 metres
Exterior Lot Lines	4.0 metres

3.4.129b.4 Other Regulations in Area B

For the purpose of this zone:

Minimum Parcel Size:

500 m² with community water and sewer system. No subdivision permitted without full community services.

Parking Requirements:

minimum 2 parking spaces for the first dwelling unit, and 1 parking space for the second dwelling unit, to be developed in accordance with Schedule '3B' of the Bylaw.

The 2nd dwelling unit is considered an accessory use to the first dwelling unit, and is permitted in an accessory building. The second dwelling unit may have a maximum floor area of 75 m².

Home Based Business uses are restricted to those uses permitted in the RS1 zone for parcels less than 2,000 m² in area.

3.4.129c.1 Permitted Uses and Density in Area C as shown in Section 3.4.129d.1

- a) Personal Care Units
 - b) Accessory Convenience Store and Personal Service Use
-

3.4.129c.2 Maximum Number and Size of Buildings and Structures in Area C

Dwelling units/parcel	75 personal care units with a combined maximum occupancy of 75 persons per parcel with community water and community sewer system.
Height of Buildings	9.0 metres
Parcel Coverage	40%

3.4.129c.3 Minimum Setback Requirements in Area C

Front Lot Line	6.0 metres
Interior Side Lot Lines	6.0 metres
Setback from Plan R573 RW	6.0 metres

3.4.129c.3 Other Regulations in Area C

For the purpose of this zone:

Minimum Parcel Size:

4600 m² with community water and community sewer system. No subdivision permitted without full community services.

Personal Care Units shall not accommodate more than 75 persons in residence.

Accessory Convenience Store and Personal Service use are permitted only as accessory uses to Personal Care Units and in the same building as Personal Care Units and may not exceed a combined floor area of 50 m².

Parking Requirements:

minimum 1 parking space per 3 units, of which 25% may be small car spaces to be developed in accordance with Schedule '3B' of the Bylaw.

Comprehensive Development Zone CD29

3.4.129d.1 Land Use Area Plan

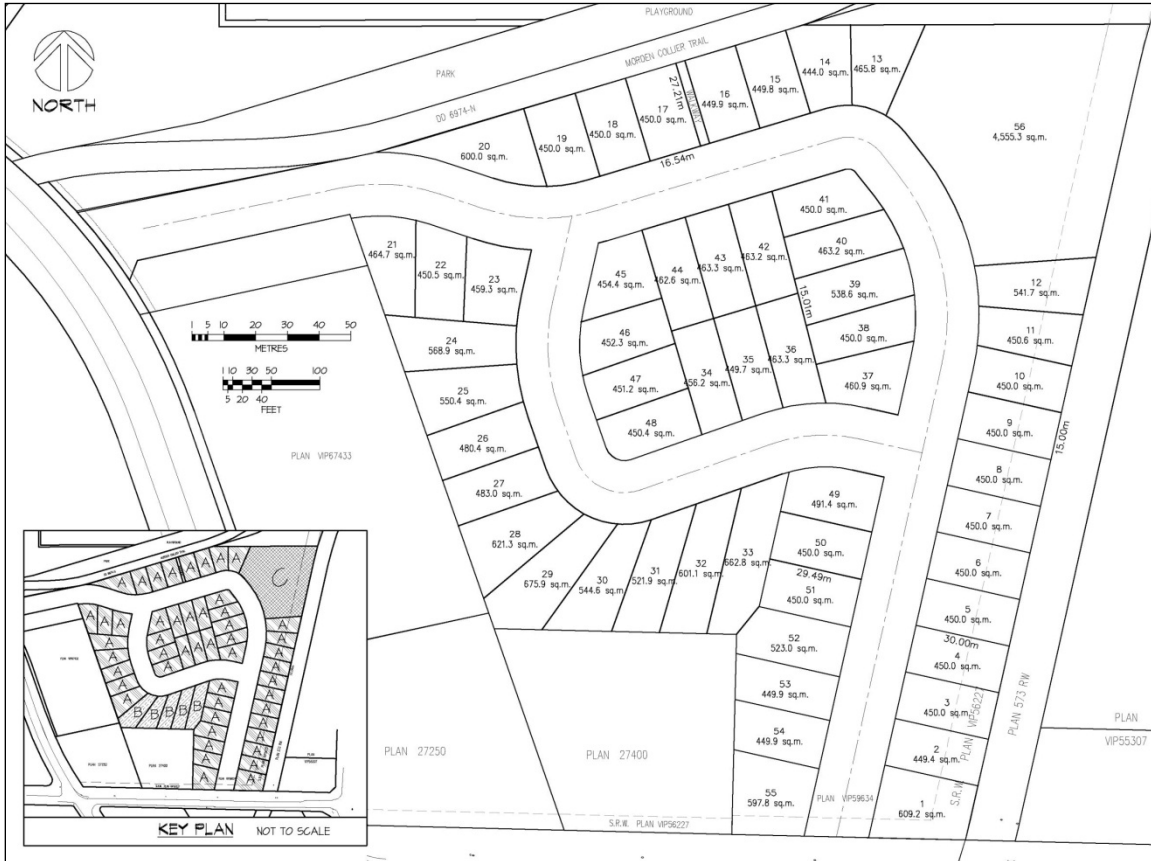

Comprehensive Development Zone CD29 Schedule 2

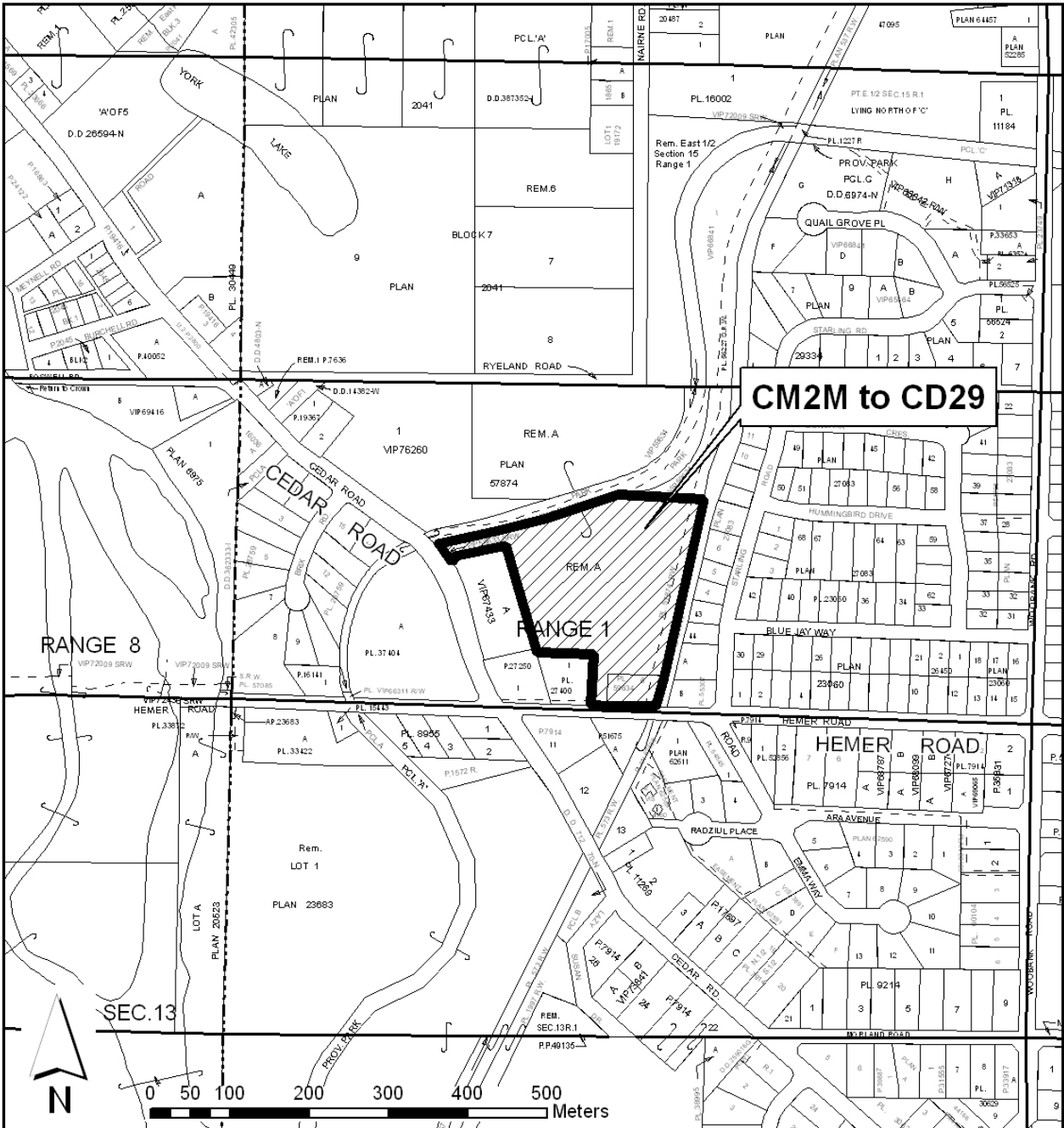

BCGS Map Sheet No. 92G.011.2.1

Section 3.4.130

**NANOOSE BAY VILLAGE CENTRE
COMPREHENSIVE DEVELOPMENT ZONE 30**

CD30

Section 3.4.130.1 Permitted Uses & Density

Permitted Uses

- a) Convenience Store
 - b) Office
 - c) Personal Service Use
 - d) Restaurant
 - e) Retail Store
 - f) Tourist Store
-

3.4.130.2 Maximum Number and Size of Buildings and Structures

Phase 1 Building	3115 m ² maximum total floor area as follows: Level 1 – maximum 1255 m ² Level 2 – maximum 1255 m ² ; and Level 3 – maximum 605 m ²
Phase 2 Building	2335 m ² maximum total floor area
Accessory Building	49 m ² maximum total floor area
Floor area ratio	0.80
Height of Buildings and Structures	14.0 m 16.0 m
Height of Clock Tower	6.0 m
Accessory Building	40%
Parcel coverage	

3.4.130.3 Minimum Setback Requirements

All buildings and structures:

Lot lines adjacent to Northwest Bay Road including corner cut off	10.0 m
Lot lines adjacent to Powder Point Road	5.0 m
For Lot lines adjacent to Lot 2, District Lot 6, Nanoose District, Plan VIP50996	
Lot lines adjacent to Lot "A", District Lot 6, Nanoose District, Plan 13317	0 m
Except That Part (Road Only) in Plan 49094	5.0 m

3.4.130.4 Minimum Parcel Size Requirements

Minimum Parcel Size:	6880 m ²
----------------------	---------------------

**NANOOSE BAY VILLAGE CENTRE
COMPREHENSIVE DEVELOPMENT ZONE 30 continued**

3.4.130.5 Other Regulations

For the purpose of this zone the following regulations apply:

- a) The site shall be developed in accordance with Schedule No. A - Roof & Site Plan prepared by Chow Low Hammond Architects Inc. and dated November 7, 2007 attached to and forming part of Amendment Bylaw No. 500.326, 2007.
- b) The Phase 1 Building shall be constructed in accordance with Schedule No. B - Elevations Plan prepared by Chow Low Hammond Architects Inc. and dated June 7, 2007 attached to and forming part of Amendment Bylaw No. 500.326, 2007.
- c) The landscaping shall be constructed in accordance with Schedule No. C – Conceptual Landscape Plan Consisting of Pages 1 and 2 prepared by Victoria Drakeford Landscape Architect and dated April 18/07 attached to and forming part of Amendment Bylaw No. 500.326, 2007.
- d) Off-Street Parking Requirements shall be as follows:
 - A minimum of 107 parking spaces shall be provided and constructed in accordance with the Schedule No. '3B' Sections 1.2, 1.4, and Part 2 of Bylaw No. 500, 1987 in association with the Phase 1 Building.
 - A minimum of 40 parking spaces shall be provided and constructed to Bylaw No. 500, 1987 standard in association with the Phase 2 Building.
- e) Despite Schedule No. '3B' Section 1.1.a) of Bylaw No. 500, 1987, a maximum of 67 off-street parking spaces of the required off-street parking spaces may be located on Lot 2, District Lot 6, Nanoose District, Plan VIP50996.
- f) Despite Schedule No. 3B' Section 1.1.b) of Bylaw No. 500, 1987, the minimum setback requirement for parking spaces adjacent to the corner cutoff of Northwest Bay Road shall be 3.0 metres.
- g) A minimum of one (1) off-street loading space shall be provided and constructed in accordance with the Schedule No. '3B' Part 3 Loading Spaces of Bylaw No. 500, 1987.

Comprehensive Development Zone CD30
Schedule No. A

Location of corner cut off

Phase 1 Building Envelope

Phase 2 Building envelope
Minimum 5.0 metre setback from lot line(s) adjacent to Lot "A", District Lot 6, Nanoose District, Plan 13317 Except That Part (Road Only) in Plan 49094

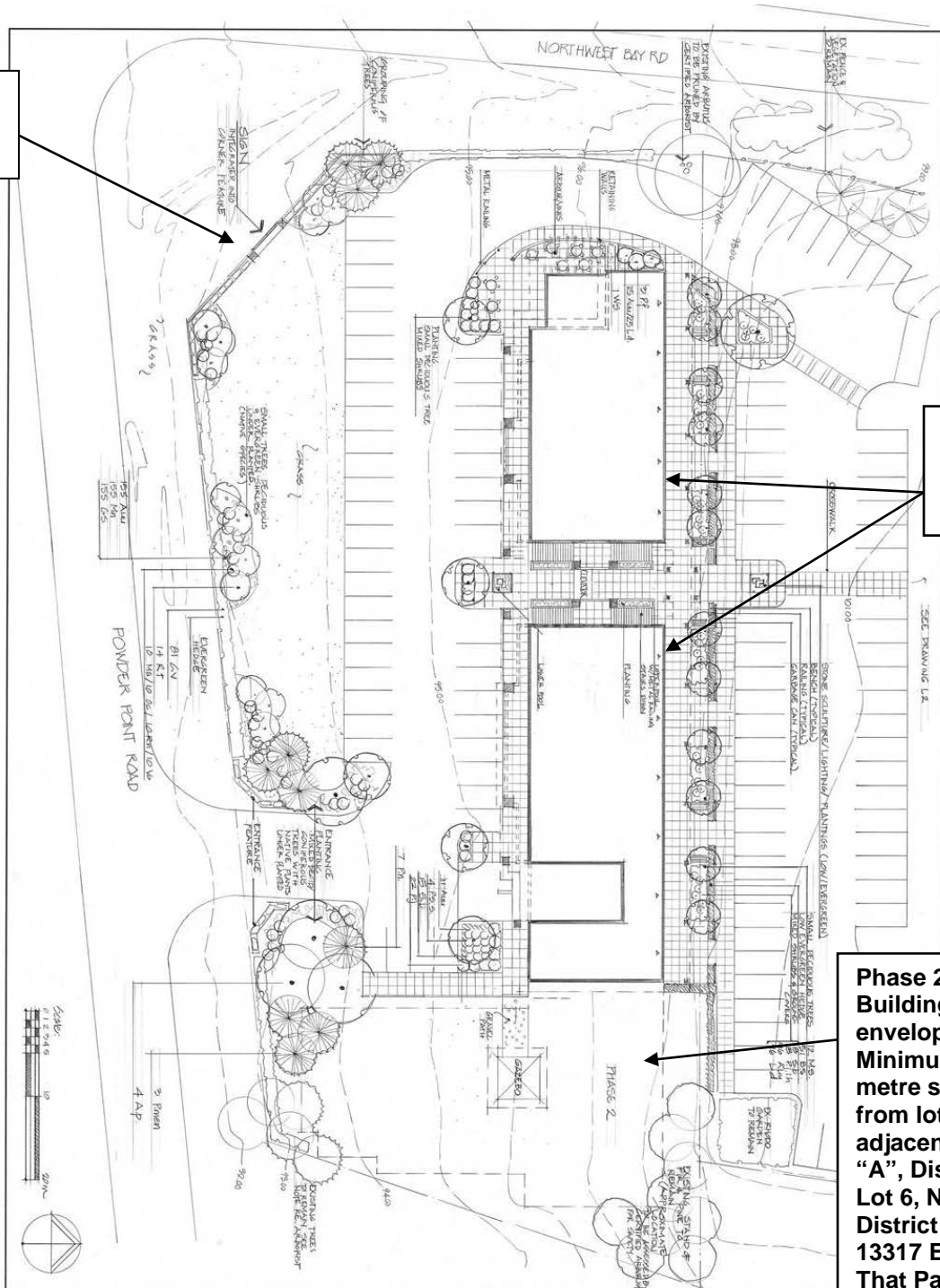

PROJECT	NANOOSE BAY VILLAGE
CLIENT	POWDER POINT ROAD NANOOSE BAY B.C.
DATE	2022-04-10
SCALE	1:250
PROJECT NUMBER	13317
DRAWING NUMBER	U1 of 2
DATE	2022-04-10
SCALE	1:250
PROJECT NUMBER	13317
DRAWING NUMBER	U1 of 2

Comprehensive Development Zone CD30
Schedule No. B

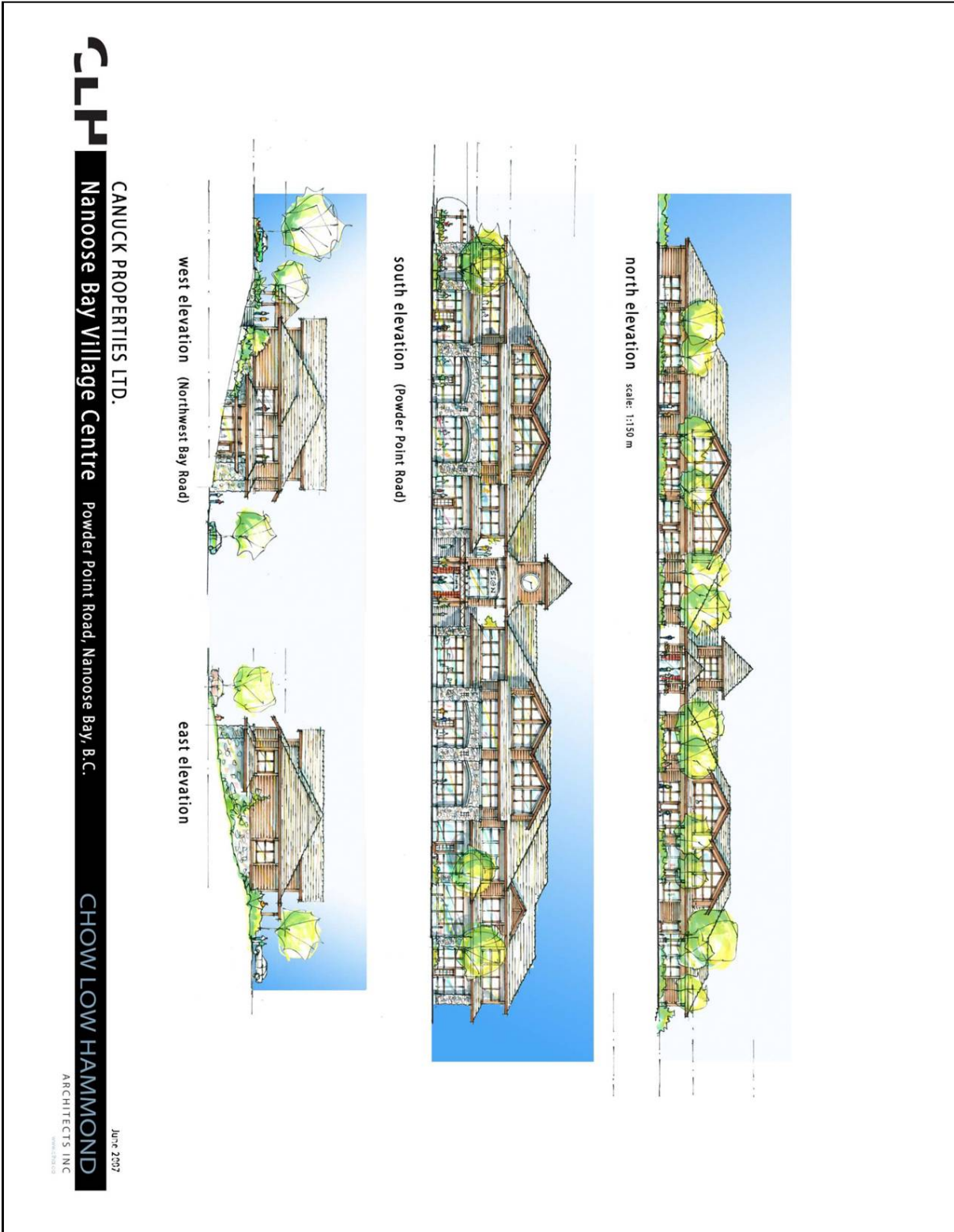

**Comprehensive Development Zone CD30
Schedule No. C (Page 1 of 2)**

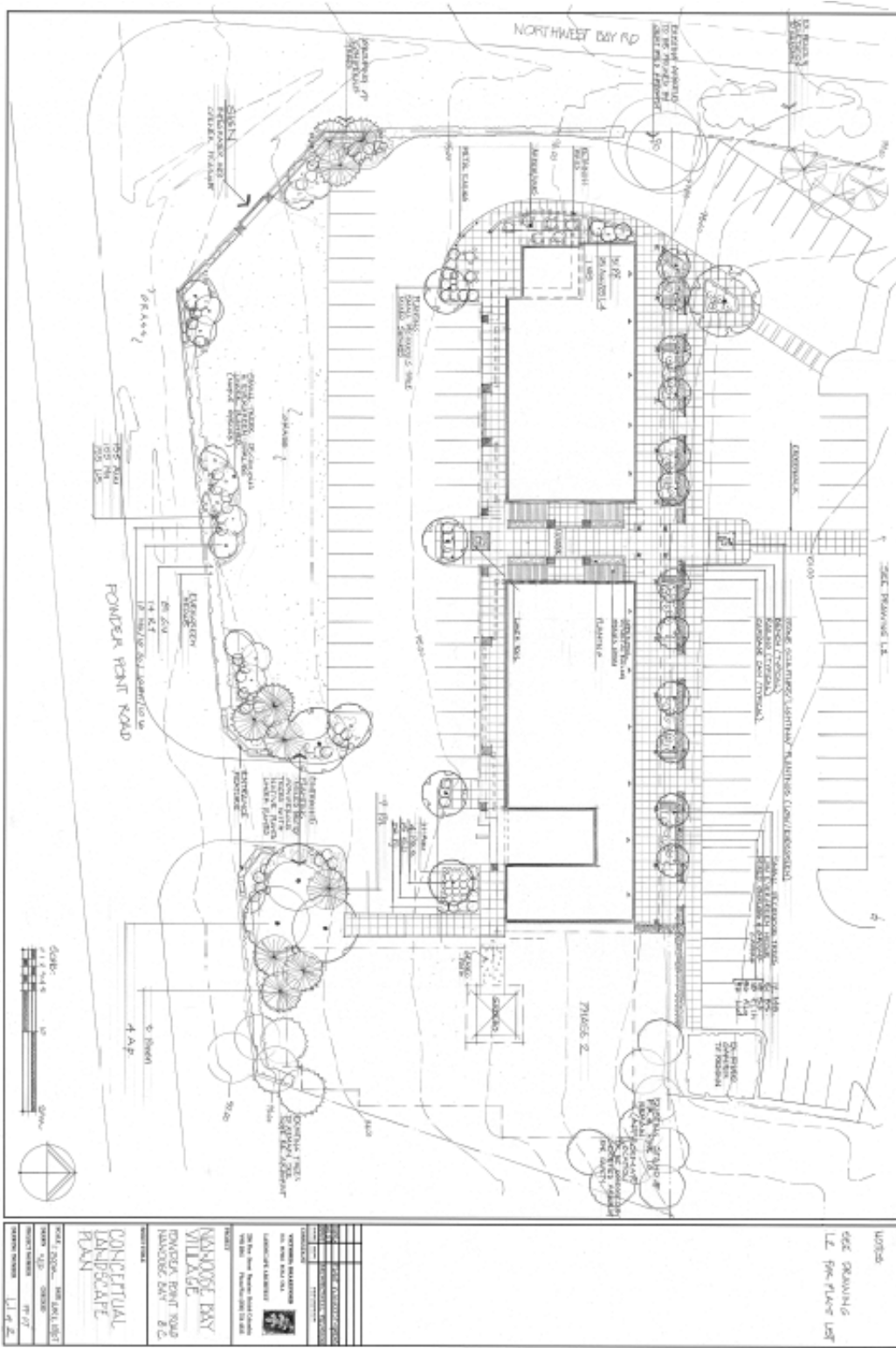

Comprehensive Development Zone CD30
Schedule No. C (page 2 of 2)



Comprehensive Development Zone CD30
Schedule No. 2

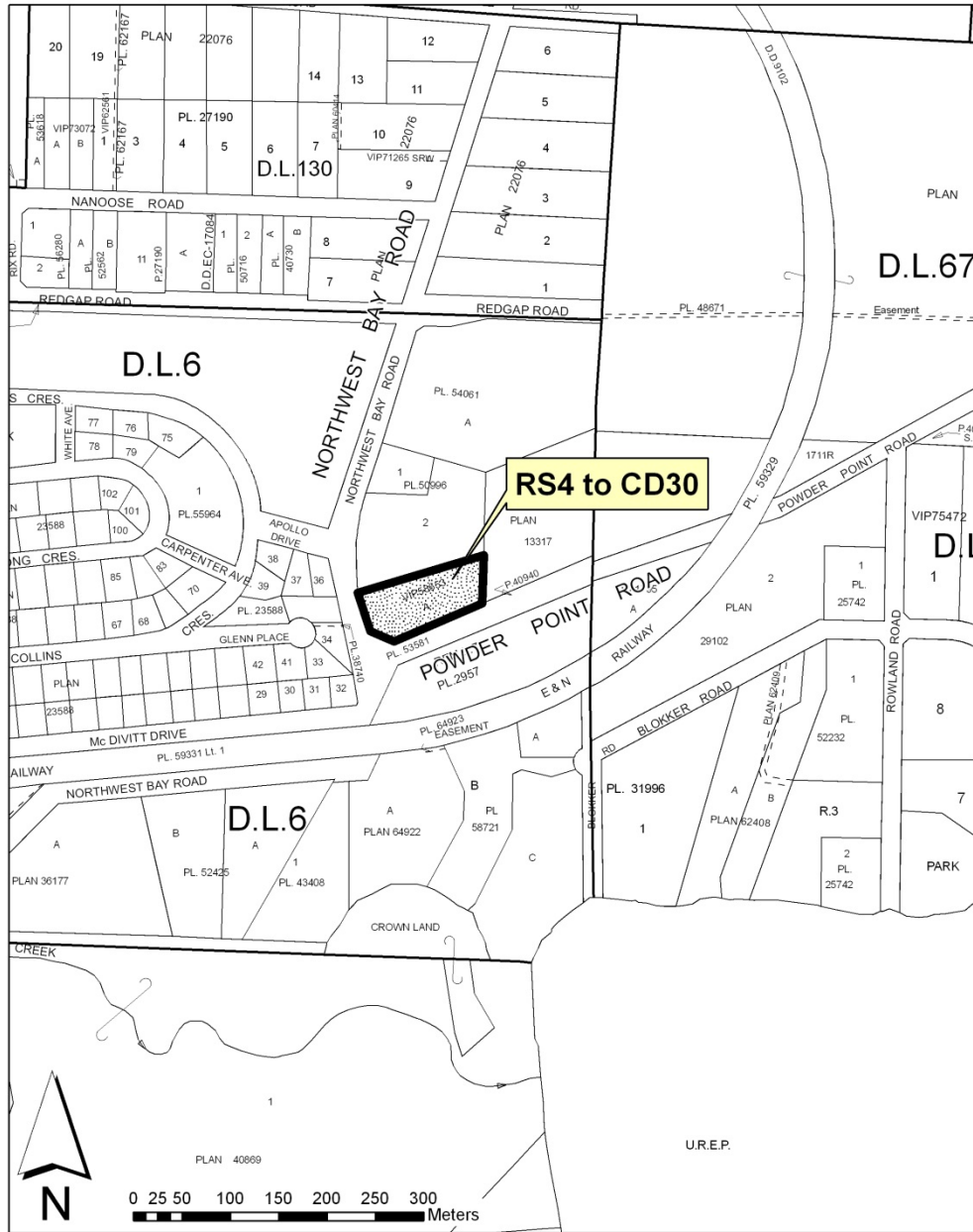

Comprehensive Development Zone CD30 Schedule No. 3

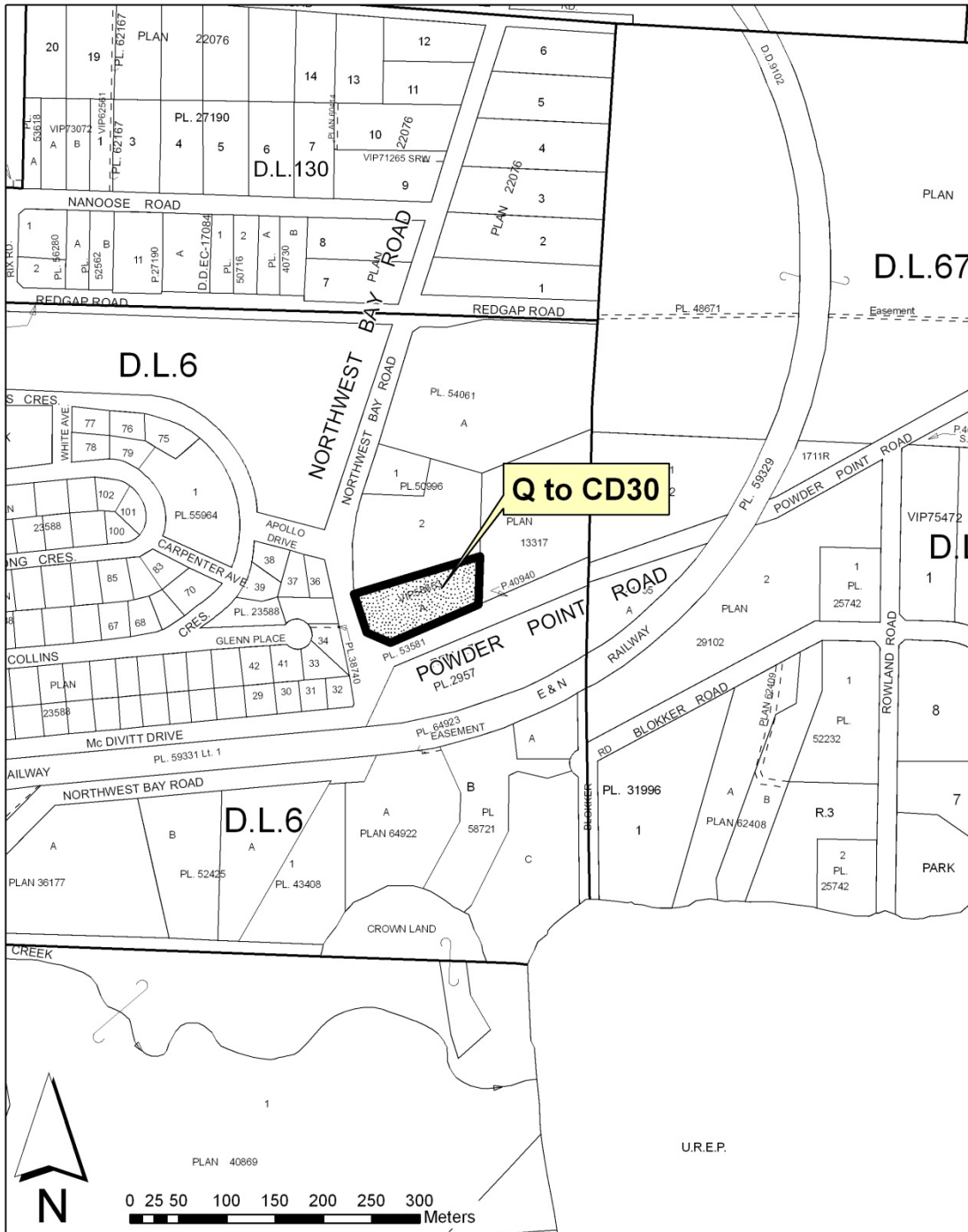

BCGS MAPSHEET NO. 92F.030.3.1

Section 3.4.132

**HORNE LAKE ROAD COMPREHENSIVE
DEVELOPMENT ZONE 3 2**

CD32¹

3.4.132.1 Permitted Uses

- a) Residential Use
 - b) Temporary Recreational Vehicle Use
 - c) Mobile Home Park
-

3.4.132.2 Maximum Number and Size of Buildings and Structures

- a) The Maximum number and type of dwelling units permitted shall be:
 - i) Nineteen (19) dwelling units, thirteen (13) of which must be mobile homes
 - ii) Mobile homes must not exceed a maximum width of 7.5 metres.
 - iii) The maximum combined floor area of all dwelling units other than mobile homes shall not exceed 340 m²
 - b) The maximum dwelling unit height shall be 8.0 metres.
 - c) The maximum number and type of accessory buildings shall be:
 - i) One (1) accessory building per dwelling unit with a maximum floor area of 10.0 m².
 - ii) Accessory building height shall not exceed 3.0 metres.
 - iii) The maximum combined floor area of all common accessory buildings shall not exceed 100.0 m².
 - iv) Common accessory building height shall not exceed 8.0 metres.
 - d) No building or structure additions are permitted to Mobile Homes, except as follows:
 - i) One (1) porch/deck addition per mobile home not exceeding:
 - a. a maximum floor area of 50.0 m² for existing deck/porch additions, excluding wheel chair ramps, and
 - b. a maximum floor area of 25.0 m² for new decks/porches or additions to existing decks/porches provided the combined total floor area of the deck/porch does not exceed 25.0 m², excluding wheel chair ramps.
 - ii) One (1) set of stairs to a secondary access not exceeding an area of 2.0m².
-

3.4.132.3 Minimum Setback Requirements

- a) All existing buildings and structures:
 - i) Exterior Lot Line: - 2.4 metres
 - ii) North Interior Side Lot Line: - 0.9 metres
 - iii) South and East Interior Lot Lines: - 4.0 metres

¹ Bylaw No. 500.328, adopted April 25, 2006

**HORNE LAKE ROAD COMPREHENSIVE
DEVELOPMENT ZONE 32 continued**

- b) All new buildings or structures, or additions or alterations to existing buildings or structures:
 - i) Exterior Lot Line – 5.0 Metres
 - ii) North Interior Side Lot Line – 2.0 metres
 - iii) South and East Interior Lot Lines: - 4.0 metres
 - c) All buildings and structures must be separated by a minimum of 2.0 metres.
-

3.4.132.4 Other Regulations

For the purpose of this zone:

- a) Temporary Recreational Vehicle Use means the use of land in designated recreational vehicle spaces for use by the traveling public and shall be limited to two (2) Recreational Vehicles only where such vehicles are fully licensed, have wheels, have no structural skirting, and have no associated decks or additions and must not be occupied for a continuous period exceeding three (3) months.
- b) Porch is defined as a structure abutting a mobile home having a roof but with walls that are open and unenclosed to the extent of at least 50% thereof and is constructed on piers or a foundation above ground.
- c) Deck is defined as a structure abutting a mobile home with no roof or walls except for visual partitions and railings and is constructed on piers or a foundation above ground.
- d) No carports or enclosed garages are permitted.

Section 3.4.133

**SCHOOLHOUSE and HAROLD ROADS LIGHT INDUSTRIAL
COMPREHENSIVE DEVELOPMENT ZONE 33**

CD33¹

3.4.133.1 Permitted Uses

Permitted Uses

- a) Light Industry
- b) Manufacturing Use
- c) Residential Use
- d) Mini Storage

3.4.133.2 Maximum Number and Size of Buildings and Structures

Dwelling units/parcel	1
Height of buildings	8.0 m
Parcel coverage	40%

3.4.133.3 Minimum Parcel Size: 5.0 hectares

3.4.133.4 Minimum Setback Requirements

Lot Lines Adjacent to Harold Road	8.0 metres
Lot Lines Adjacent to Schoolhouse Road	8.0 metres
Other Lot Lines	5.0 metres

3.4.133.5 Other Regulations

For the purpose of this zone:

- a) *Manufacturing Use* means the assembling and manufacturing of a product or products in a building only and may include indoor accessory retail sales of the product(s) produced to a maximum of 10% of the floor area of the building and may include an accessory office use.
- b) *Mini Storage* Means a building or buildings containing separate, individual self-storage units, each with a separate entrance designed to be rented or leased to the general public for private storage of personal goods, materials, and equipment and does not include outside storage or the rental or lease of moving trucks or moving trailers.

All uses must be fully contained within a building.

¹ Bylaw No. 500.333, adopted March 25, 2008

**SCHOOLHOUSE and HAROLD ROADS LIGHT INDUSTRIAL
COMPREHENSIVE DEVELOPMENT ZONE 33** continued

3.4.133.6 Landscaping

- a) Landscaping shall be provided to the satisfaction of the Regional District of Nanaimo along the perimeter of Schoolhouse and Harold Roads excluding entrances to a minimum width of 5.0 metres, and shall include, a minimum of seventy-five percent screening from grade level to a height of 3.0 metres and at least 25 percent screening from a height of 3.0 metres to 5.0 metres above grade.
- b) Landscaping shall at minimum include planting one evergreen tree for every 3.0 metres of parcel frontage.
- c) All landscaping abutting parking or other vehicle access areas on site shall be protected by a permanent curb a minimum of 15 cm in height to protect landscaping from potential vehicular damage.
- d) Except where varied by this zone, landscaping shall be provided in accordance with Schedule 3F – Landscaping Regulations and Standards of Bylaw No. 500.

Section 3.4.134

**RIDGE TOWN HOMES COMPREHENSIVE
DEVELOPMENT ZONE 34**

CD34¹

3.4.134.1 Permitted Uses & Minimum Site Area

Permitted Uses and Minimum Site Area	Required Site with Community & Community Sewer Systems
a) Multiple Dwelling Unit Development	4.6 ha
b) Common Property Accessory Building	

3.4.134.2 Maximum Number and Size of Buildings and Structures

Common Property Accessory Building	1
Dwelling units/parcel	35
Height of buildings	8.0 m
Parcel coverage	35 %

3.4.134.3 Minimum Setback Requirements

For all buildings and structures unless otherwise set out in subsection 3.4.134.4:

Lot line adjacent to Common Property access	7.0 metres
Phased strata lot line	0 metres
All other lot lines	8.0 metres

3.4.134.4 Other Regulations

For the purpose of this zone:

A maximum of 1 Common Property Accessory Building, for use by the strata, may be placed within the Common Property area not being used for access or parking purposes, provided the building does not exceed 3.0 metres in height nor a total floor area of 10.0 m². The minimum setback for a Common Property Accessory Building shall be 5.0 metres from a lot line adjacent to Common Property access. All other minimum setbacks set as out in subsection 3.4.134.3 are applicable.

¹ Bylaw No. 500.336, adopted January 23, 2007

Comprehensive Development Zone CD34 Schedule 3

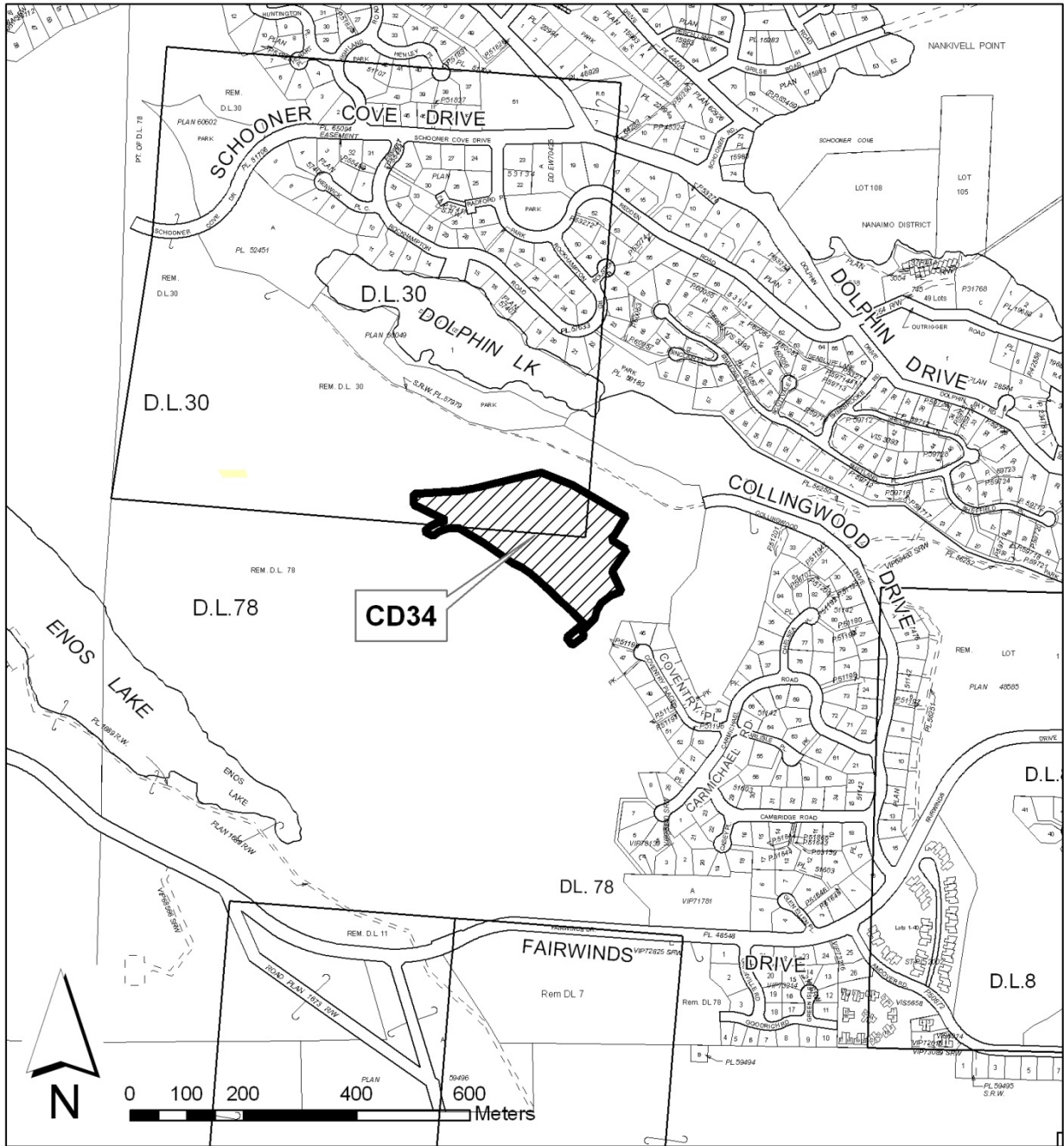

Comprehensive Development Zone CD34 Schedule 5

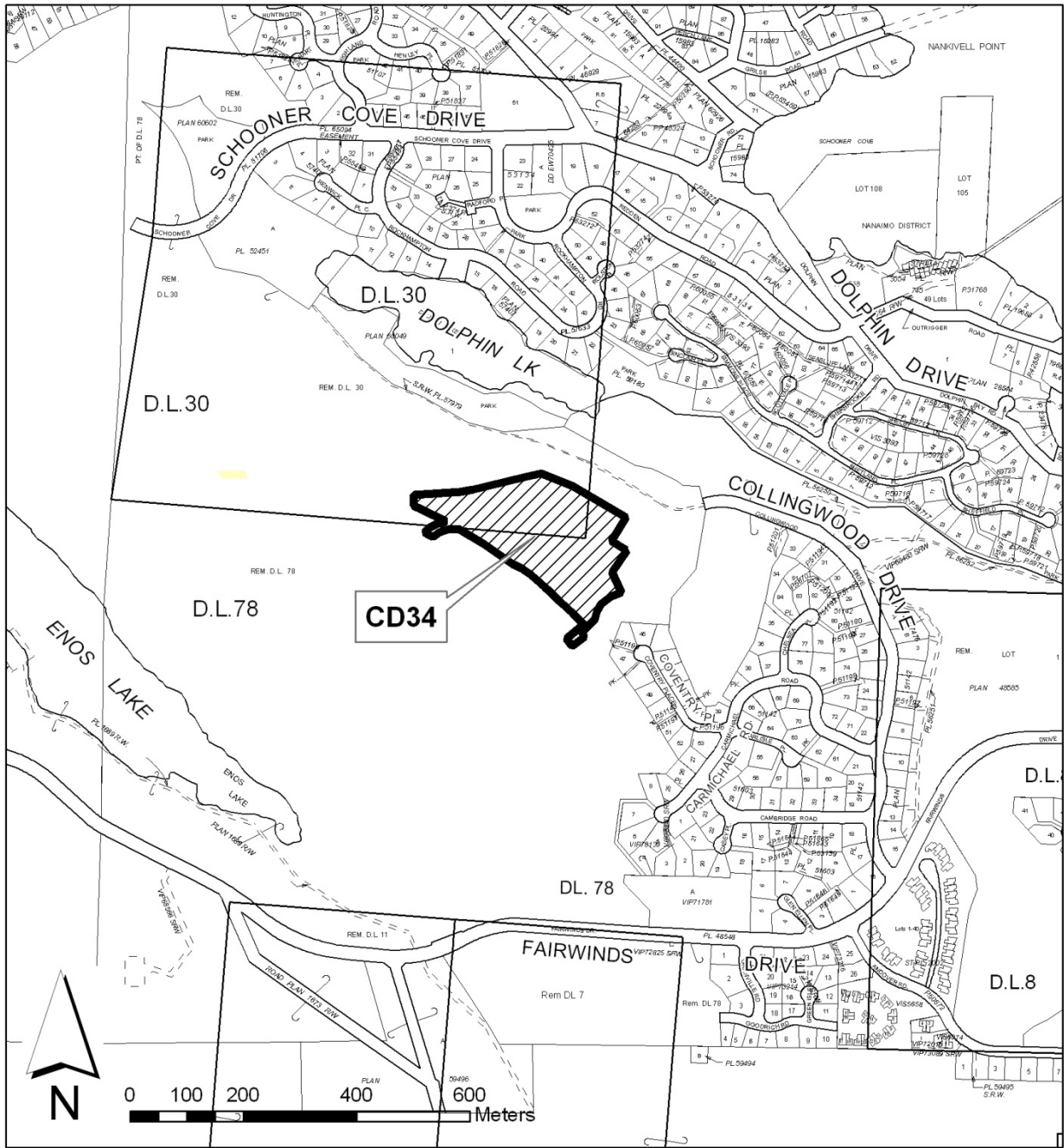

Section 3.4.135

**ROCKCLIFFE
COMPREHENSIVE DEVELOPMENT ZONE 35¹**

CD35

3.4.135.1 Permitted Uses & Density

Permitted Uses

- a) Residential Use
- b) Home Based Business Use
- c) Common Property Accessory Building

Density

- a) The maximum number of lots that may be created by subdivision within the area as shown outlined on Schedule No. 4 of Bylaw No. 500.336 shall be 26 bare land strata lots.
 - b) The minimum parcel size for a bare land strata lot shall be 504 m².
-

3.4.135.2 Maximum Number and Size of Buildings and Structures

Common Property Accessory Building	1
Dwelling units/parcel	1
Height of buildings	9.0 m
Parcel coverage	60 %

3.4.135.3 Minimum Setback Requirements

For all buildings and structures:

Lot line adjacent to Bonnington Drive	5.0 metres
Interior side lot line	1.2 metres
Lot line adjacent to Common Property	2.0 metres

3.4.135.4 Minimum Parcel Size

504 m² with community water and community sewer service connections

3.4.135.5 Other Regulations

For the purpose of this zone:

- a) A maximum of 1 Common Property Accessory Building, for use by the strata, may be placed within the Common Property area not being used for access or parking purposes, provided the building does not exceed 3.0 metres in height nor a total floor area of 10.0 m². All minimum setbacks as set out in subsection 3.4.135.3 are applicable.
- b) Home Based Business Use – a home based business activity in this zone is restricted to an office use which is wholly contained within a dwelling unit to a maximum of 20 % of the dwelling unit floor area and specifically a home based business or any portion of it shall not be contained within an attached garage. All other regulations set out in section 3.3.14 apply to this zone.

¹ Bylaw No. 500.336, adopted January 23, 2007

Comprehensive Development Zone CD35 Schedule 4

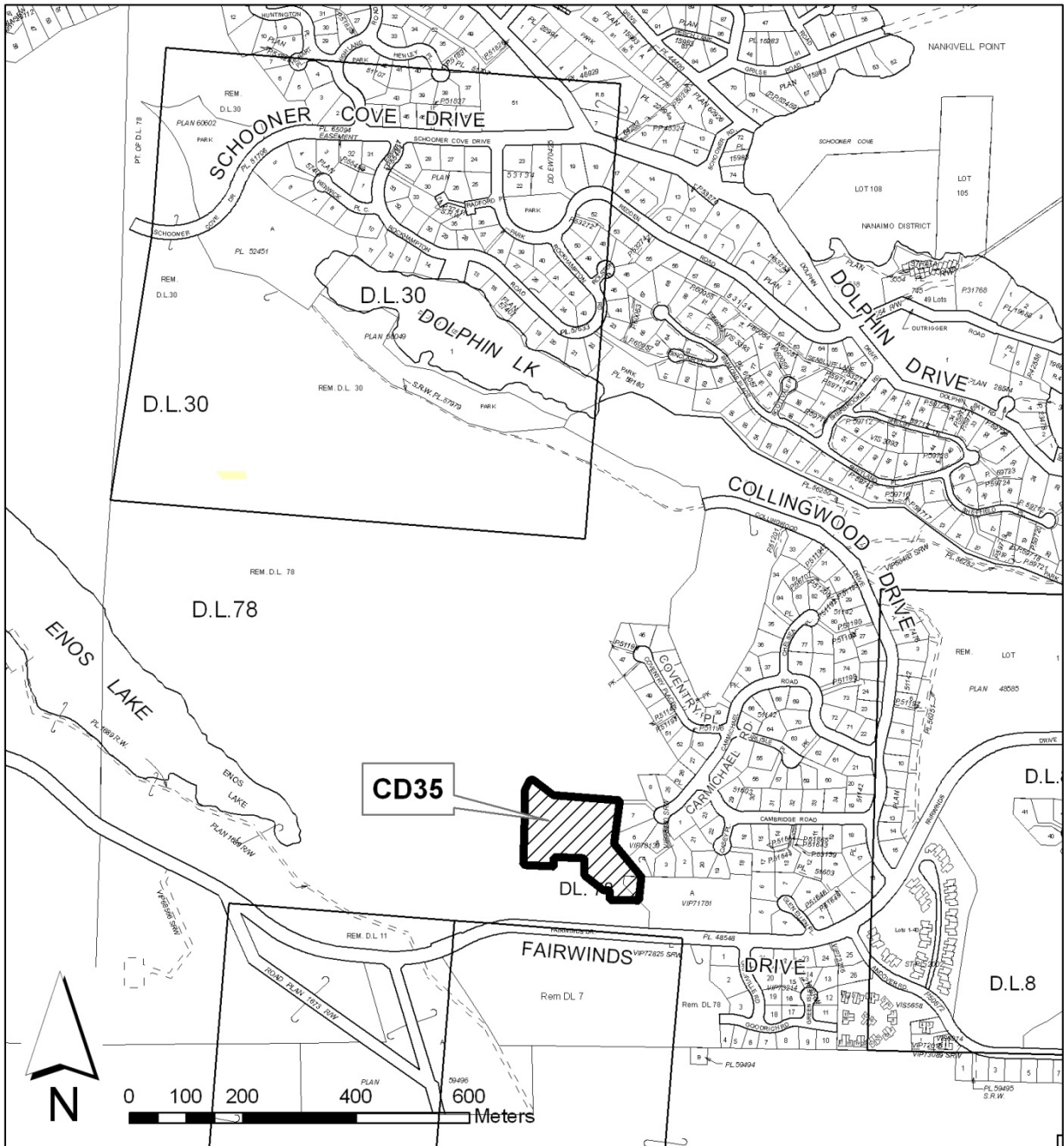

Comprehensive Development Zone CD35 Schedule 6

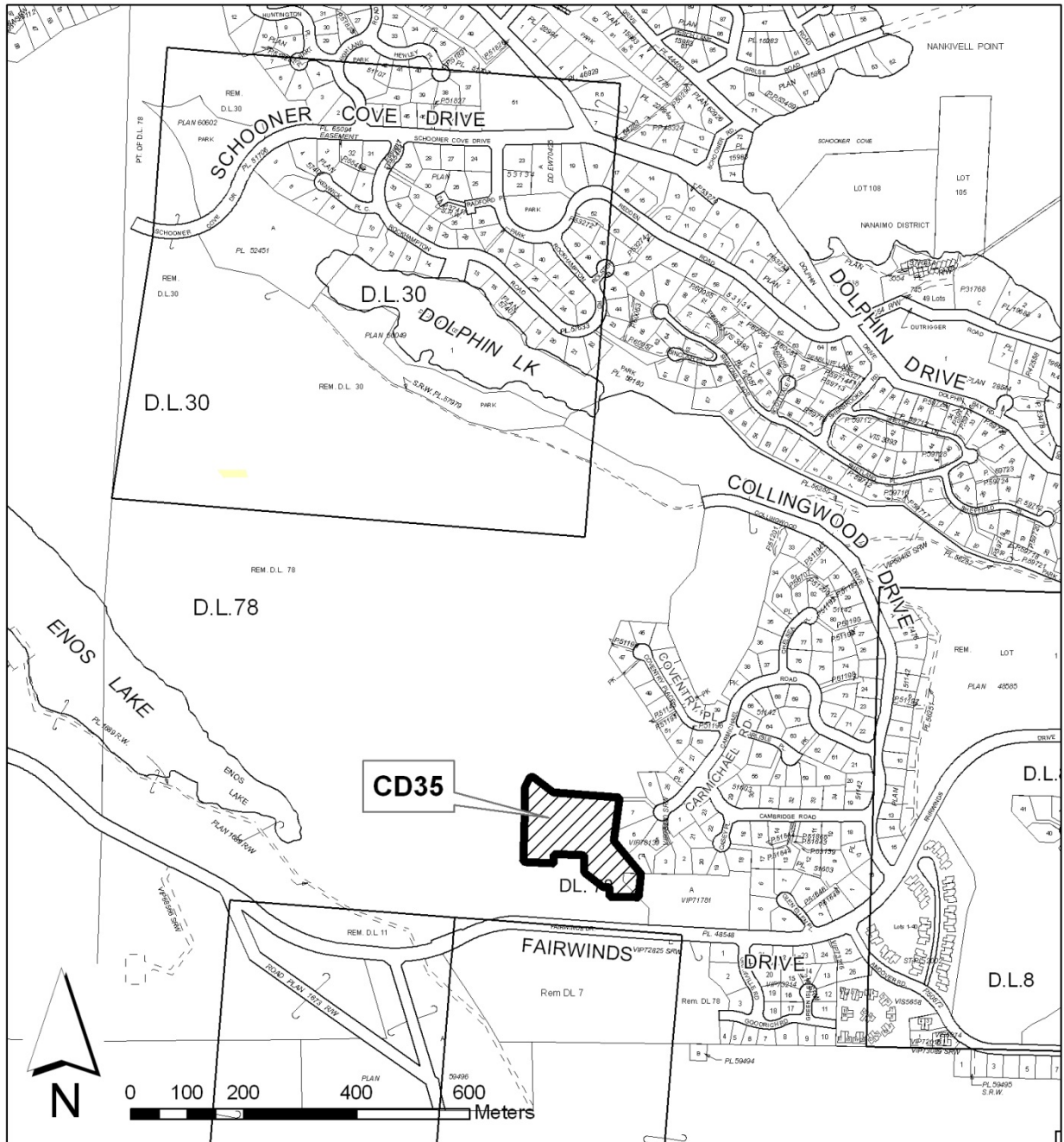

Section 3.4.136

**1 6 8 0 T I M B E R L A N D S
C O M P R E H E N S I V E D E V E L O P M E N T Z O N E 3 6 ¹**

CD36

3.4.136.1 Permitted Uses & Minimum Site Area

Permitted Uses and Minimum Site Area Total Required Site Area For All

Permitted Uses

- | | |
|----------------------------|---------|
| a) Neighbourhood Pub | 0.55 ha |
| b) Wine and Beer Store | |
| c) Hotel | |
| d) Accessory Dwelling Unit | |

3.4.136.2 Maximum Number and Size of Buildings and Structures

Accessory Dwelling Unit	1
Hotel units/parcel	11
Height of building	9.0 m
Parcel coverage	35%

3.4.136.3 Minimum Setback Requirements

For all buildings and structures unless otherwise set out in subsection 3.4.136.4:

All lot lines 7.0 metres

3.4.136.4 Other Regulations

For the purpose of this zone:

- a) Off-Street Parking and Loading Requirements
 - i. A minimum of 78 off-street parking spaces shall be provided on site.
 - ii. Off-street parking areas shall meet the minimum dimension requirements in accordance with Schedule No. '3B'.
 - iii. Off street parking spaces may be located within the minimum setback areas.
 - iv. All off-street parking spaces and aisle ways are to be clearly delineated and signed in accordance with Schedule No. '3B'.
 - v. Disability parking spaces shall meet the minimum requirements in accordance Schedule '3B'.
 - vi. A minimum of 1 off-street loading space shall be provided on site and shall meet the minimum dimension requirements in accordance with Schedule No. '3B'.

¹ Bylaw No. 500.341 adopted February 26, 2008

**1680 TIMBERLANDS COMPREHENSIVE
DEVELOPMENT ZONE 36 continued**

b) Garbage Disposal Area Requirements

A minimum of 1 garbage disposal area shall be provided on-site and shall be a minimum 2.5 metre setback from all lot lines; a minimum of 8.0 m² in size; and shall be screened with a combination of hard and soft landscaping.

c) Landscaping Requirements

Landscaping shall be provided, at a minimum, at the access from Timberlands Road, at the entrance to the building; and throughout the off-street parking area where possible.

d) Subdivision

No subdivision is permitted.

Comprehensive Development Zone CD36 Schedule 2

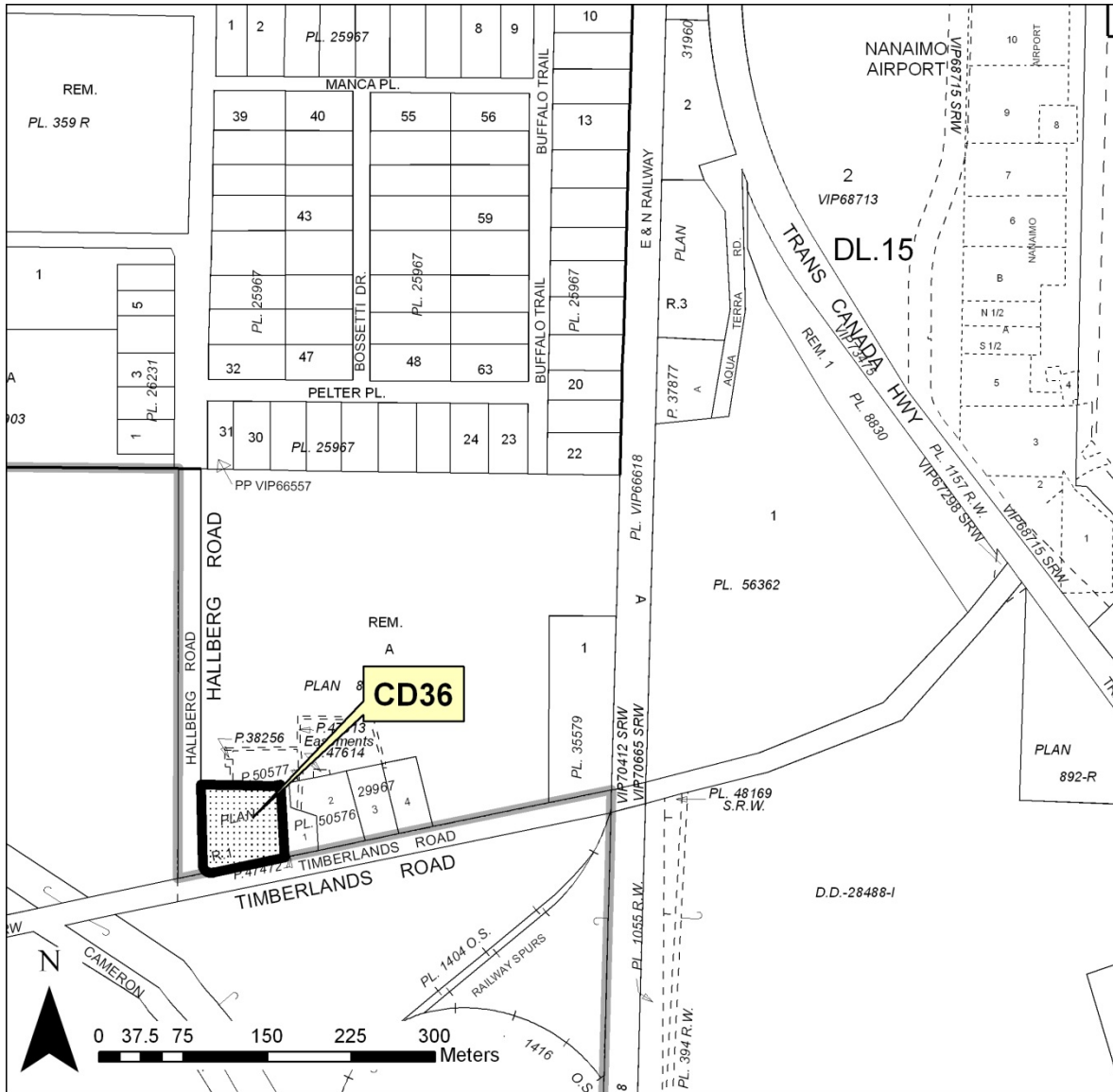

Comprehensive Development Zone CD36 Schedule 3

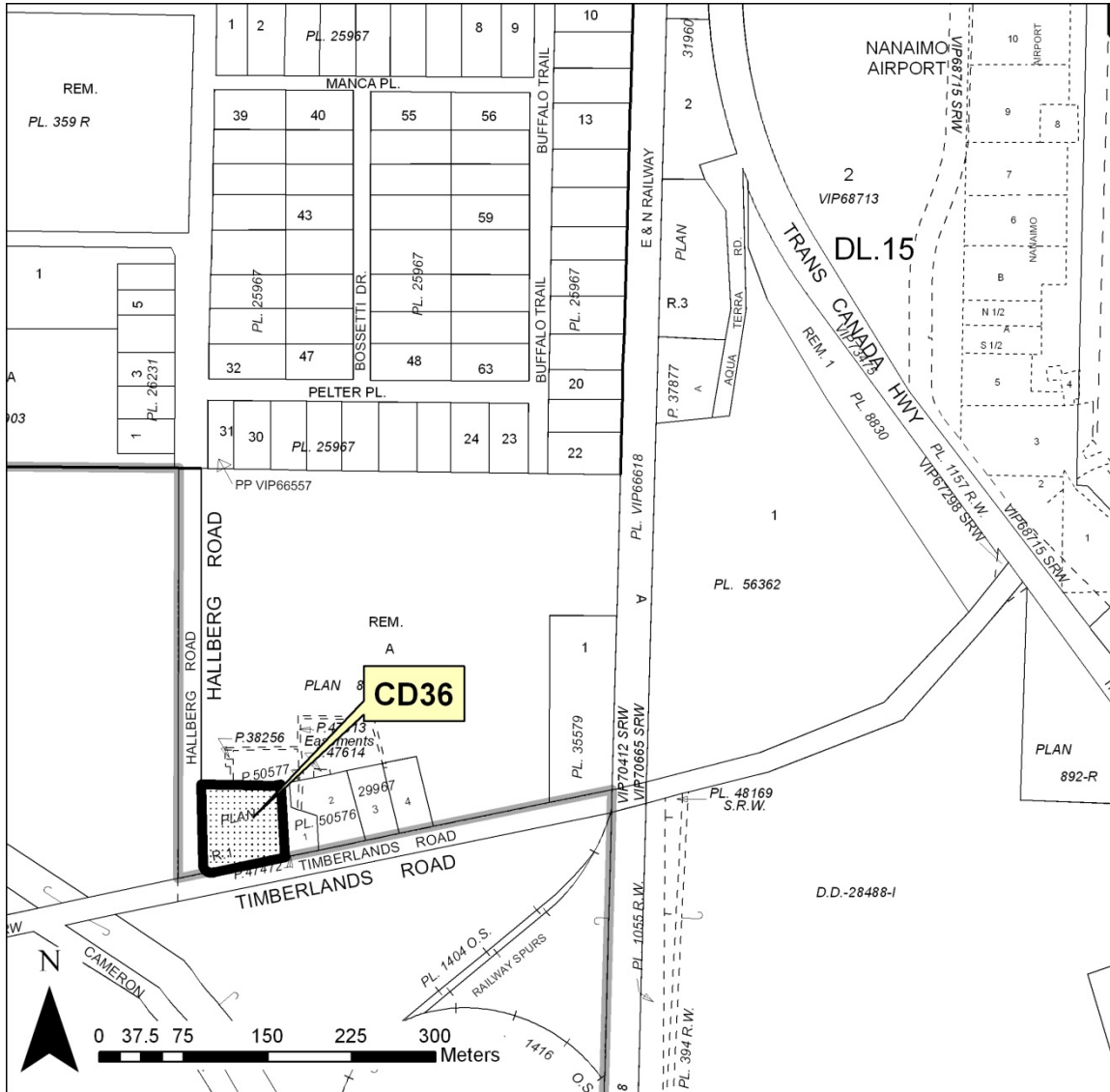

Section 3.4.137

**MAIN ROAD LIGHT INDUSTRIAL¹
COMPREHENSIVE DEVELOPMENT ZONE 37**

CD37

3.4.137.1 Permitted Uses Minimum Site Area Requirements

a) Light Industry	8000 m ²
b) Residential Use	n/a
c) Mini Storage	8000 m ²
d) Contractors Business	8000 m ²
e) Home Based Business	n/a

3.4.137.2 Maximum Number and Size of Buildings and Structures

Dwelling units/parcel	1
Height of buildings	8.0 m
Parcel coverage	35%

3.4.137.3 Minimum Parcel Size:

1.0 Hectare with or without community water and community sewer services.

3.4.137.4 Minimum Setback Requirements

Front Lot Line	10.0 metres
Rear Lot Line and Interior Side Lot Line	5.0 metres
All other Lot Lines	8.0 metres

3.4.137.5 Other Regulations

- a) All uses must be fully contained within a building, with the exception of outdoor storage areas.
- b) All outdoor storage areas must be located to the rear of buildings, must not be located between any building and lot line adjacent to Main Road, and must be screened to a minimum height of 3.0 metres with a combination of fencing and landscaping on all sides, excluding entrance ways.
- c) A No setback requirement shall be required from the front, rear, side, or other lot line for fences 3.0 metres or less in height.
- d) All off-street parking areas must be paved.
- e) All storm water runoff from buildings and other non-pervious surfaces must be directed through an engineered oil-water separator appropriately sized to accommodate anticipated flows and must be maintained in accordance with the manufacturer's recommendations.
- f) All storm water drainage must be retained on site, unless otherwise approved by the Ministry of Transportation
- g) With respect to Home Based Business uses – the regulations set out in Section 3.3.14 applicable to Residential 2 zone shall apply to this zone.
- h) Except where varied by this zone, off-street parking and loading spaces shall be provided in

¹ Bylaw No. 500.338, 2006, adopted December 11, 2007

accordance with Schedule '3B' of this zone.

**MAIN ROAD LIGHT INDUSTRIAL COMPREHENSIVE
DEVELOPMENT ZONE 37 continued**

3.4.137.6 Definitions

For the purpose of this zone:

- a) *Light Industry* means the wholesale, warehousing, testing, service, or repair of non-hazardous articles, substances, materials, fabrics or compounds fully contained within a building and may include accessory sales of goods, wares, merchandise, or articles and an accessory office.
- b) *Contractors Business* means the use of a building or buildings for the storage of tools, equipment, and non-hazardous materials, the display of building supplies, landscaping supplies, and other building materials, and may include an accessory office, and retail sales accessory to the principle use.
- c) *Manufacturing Use* means the assembling and manufacturing of a product or products fully contained in a building and may include indoor accessory retail sales of the product(s) produced to a maximum of 10% of the floor area of the building and may include an accessory office use.
- d) *Mini Storage* means a building or buildings containing separate, individual self-storage units each with a separate entrance designed to be rented or leased to the general public for private storage of personal goods, materials, and equipment and does not include outside storage or the rental or lease of moving trucks or moving trailers.

3.4.137.7 Landscaping

- a) Landscaping shall be provided to the satisfaction of the RDN adjacent to Main and Tees Roads excluding entrances to a minimum width of 5.0 m and shall include a minimum of 75% screening from grade level to a height of 3.0 m and at least 25 % screening from a height of 3.0 m to 5.0 m above grade.
- b) Landscaping shall, at a minimum, include planting one evergreen tree for every 3.0 m of parcel frontage.
- c) All landscaping abutting off-street parking or other areas on site that are accessible to vehicles shall be protected by a permanent curb of a minimum of 15 cm in height to protect landscaping from potential vehicular damage.
- d) Except where varied by this zone, landscaping shall be provided in accordance with Schedule '3F' – Landscaping Regulations and Standards.

3.4.137.8 Required Number of Off Street Parking Spaces

Use	Required Parking Spaces
Contractors Business	1 per 15.0 m ² of floor area used for sales plus; 1 for each employee working on any given shift plus; 1 per 175 m ² of floor area used for storage; plus, 1 per 95 m ² of floor area used for display

Comprehensive Development Zone CD37 Schedule 2

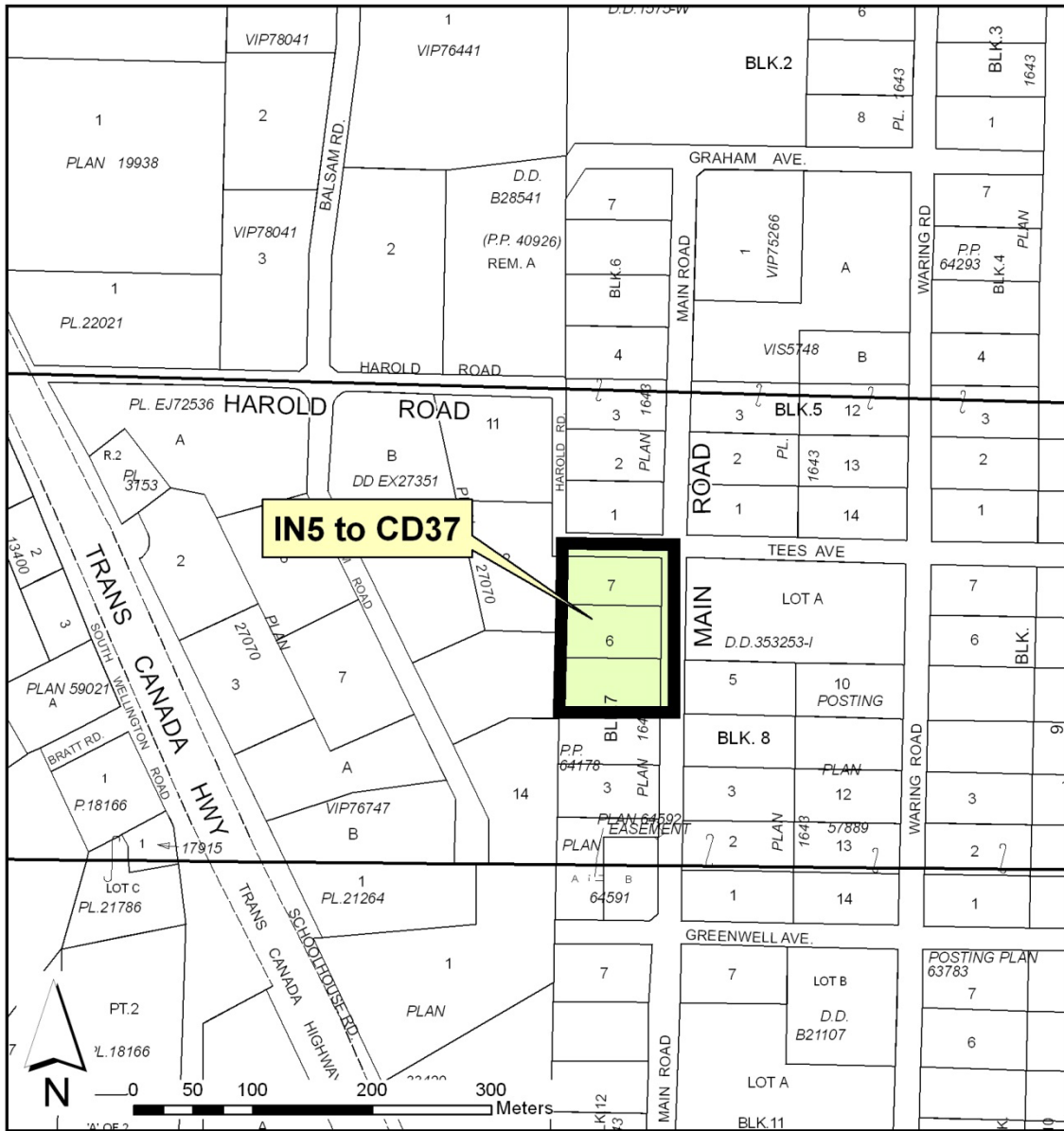

BCGS Map Sheet No. 92G.001.4.3

Comprehensive Development Zone CD37 Schedule 3

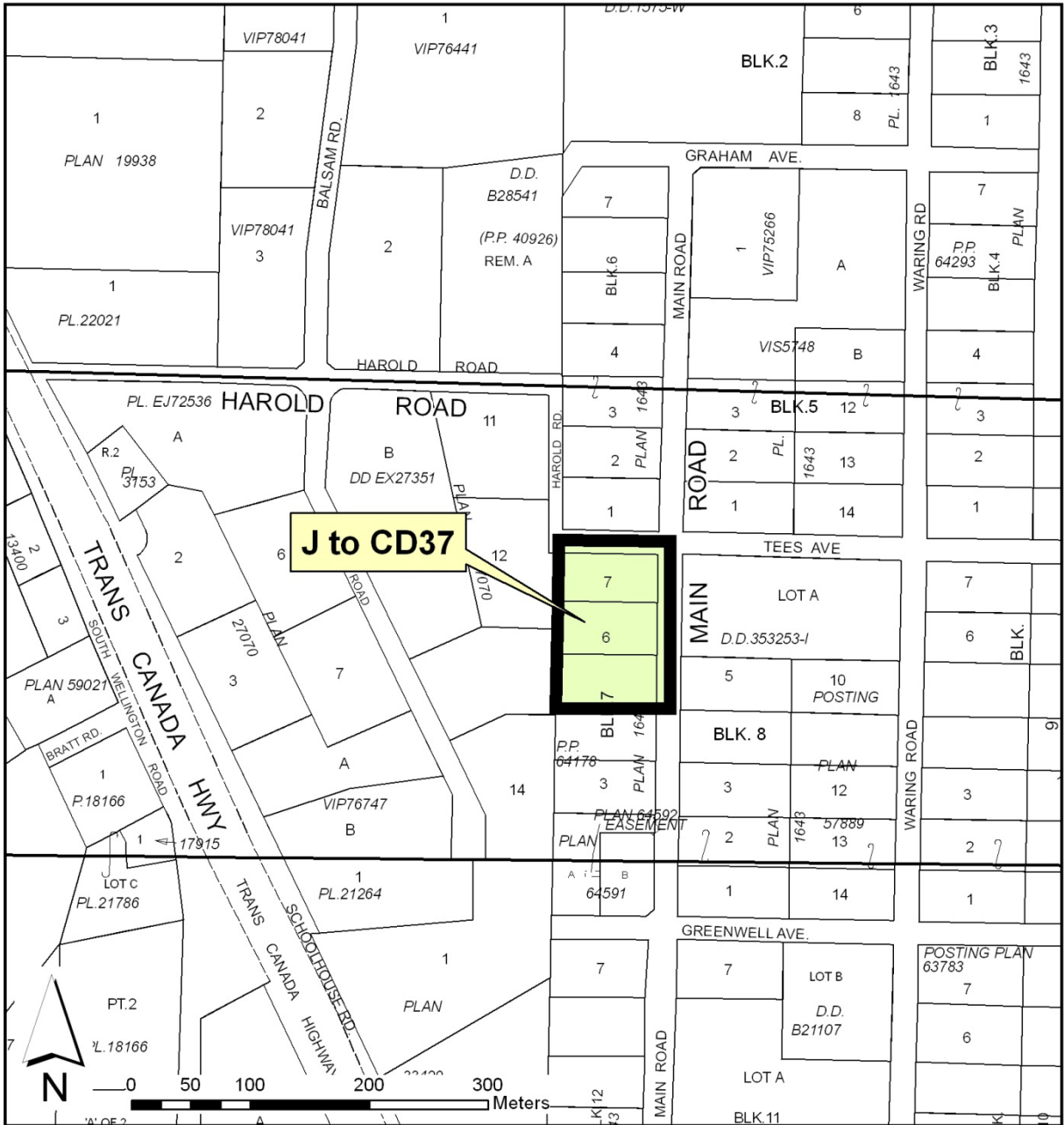

BCGS Map Sheet No. 92G.001.4.3

Section 3.4.141

**QUALICUM BAY SENIORS DEVELOPMENT¹
COMPREHENSIVE DEVELOPMENT ZONE 41**

CD41

3.4.141.1 Permitted Uses

Multiple Dwelling Units

3.4.141.2 Maximum Size of Buildings and Structures

Height	8.0 m
Parcel coverage	50%

3.4.141.3 Minimum Setback Requirements

Front Lot Line	8.0 m
Other Lot Line	5.0 m

except where any part of a parcel is adjacent to or contains a watercourse then the regulations in Section 3.3.8 shall apply

3.4.141.4 Other Regulations

For the purpose of this zone, notwithstanding Schedule '3B', Off-Street Parking & Loading Spaces, Table 1, the number of required parking spaces is as follows:

1 space per dwelling unit plus 6 visitor spaces.

¹ Bylaw No. 500.366, adopted January 25, 2011

Comprehensive Development Zone CD41 Schedule 1

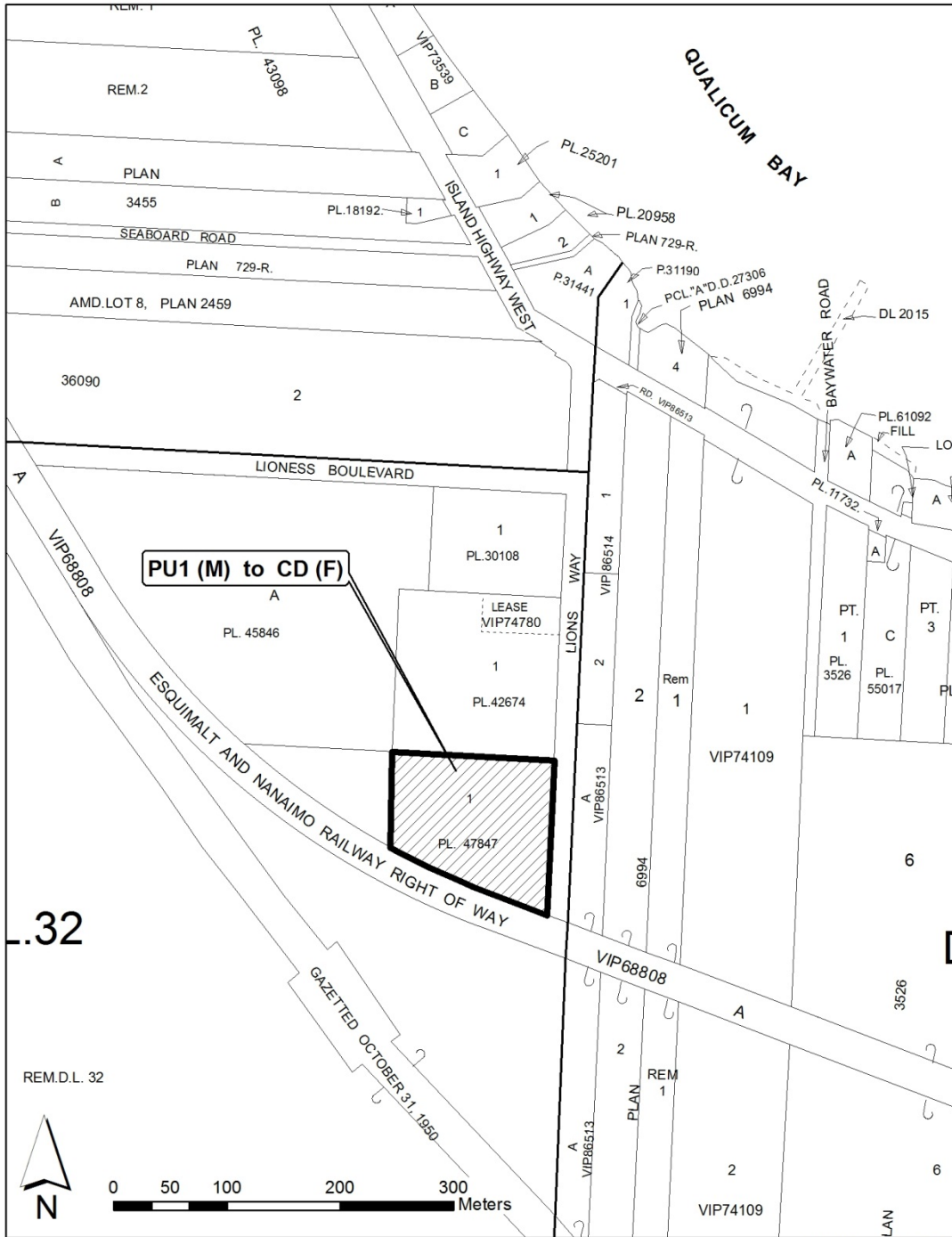

Section 3.4.142

**CROWN AND ANCHOR CAMPGROUND
COMPREHENSIVE DEVELOPMENT ZONE 42¹**

CD42

Section 3.4.142.1 Permitted Principal Uses

- a) Recreational Vehicle Park

3.4.142.2 Permitted Accessory Uses

- a) Accessory Buildings and Structures
- b) Accessory Office and Retail Store
- c) Accessory Dwelling Unit

3.4.142.3 Maximum Number and Size of Buildings and Structures

Dwelling units/parcel	1 (maximum floor area 35 m ²)
Accessory Office and Retail Store	A maximum combined gross floor area of 100 m ²
Height	8.0 m
Parcel coverage	40%

3.4.142.4 Minimum Setback Requirements

For all buildings and structures unless otherwise set out in subsection 3.4.142.5:

All lot lines 3.0 m

Except where:

- a) An internal access road is located within the property then the minimum setback from the lot line may be reduced to 1.0 metre;
- b) Any part of a parcel is adjacent to or contains a watercourse then the minimum setback shall be 10 metres for buildings and structures, and 0 metres for an existing pedestrian bridge and internal road crossing; and,
- c) The adjoining parcel is zoned industrial or commercial then the setback from the common interior side lot line may be reduced to zero.

3.4.142.5 Other Regulations

- a) Notwithstanding Schedule '3C', 'Campground Regulations and Standards' of "Regional District of Nanaimo Land Use and Subdivision Bylaw No. 500, 1987", washroom facilities shall be located a maximum of 200 metres from any camping space and a minimum of 4.5 metres from any camping space.
- b) The recreational vehicle park shall be developed in accordance with Schedule '3C', 'Campground Regulations and Standards' of "Regional District of Nanaimo Land Use and Subdivision Bylaw No. 500, 1987", except as varied in this amendment bylaw.

3.4.142.6 Parking Requirements

¹ Bylaw No. 500.367, adopted April 26, 2011

Section 3.4.143

**SCHOONER BAY MANOR SENIORS MOBILE HOME PARK
COMPREHENSIVE DEVELOPMENT ZONE 43¹**

CD43

3.4.143.1 Permitted Principal Uses and Minimum Site Area

- a) Mobile Home Park 6.0 ha

3.4.143.2 Permitted Accessory Uses

- a) Accessory Buildings and Structures for each mobile home and the Mobile Home Park
- b) Accessory Office

3.4.143.3 Maximum Number and Size of Buildings and Structures

- a) Units per parcel 99 mobile homes.
Height 8.0 m
- b) Accessory Buildings 10 m² per mobile home.
Height 3.0 m
- c) Common Accessory Buildings Maximum combined floor area of 200 m² for the Mobile Home Park.
Height 6.0 m
- d) Accessory Office Maximum floor area 20 m² for the Mobile Home Park.
Height 6.0 m
- e) Porch/Deck/Carport Additions One (1) porch/deck/carport addition per mobile home unit not exceeding a floor area of 20m², excluding wheel chair ramps; and
One (1) entrance stairs to a secondary access not exceeding a floor area of 2m².
Height 6.0 m

3.4.143.4 Minimum Setback Requirements

For all buildings, structures or mobile homes:

- a) From all lot lines 4.5 m
- b) From other buildings, structures or mobile homes 3.0 m
- c) From an internal access road or common parking area 2.0 m
- d) Except where any part of a parcel is adjacent to or contains a watercourse then the regulations of Section 3.3.8 shall apply.

¹ Bylaw No. 500.368, adopted October 4, 2011

**SCHOONER BAY MANOR SENIORS MOBILE HOME PARK COMPREHENSIVE
DEVELOPMENT ZONE 43 continued**

3.4.143.5 Other Regulations

1. For the purpose of this zone, notwithstanding Schedule '3D', Residential Mobile Home Park Regulations and Standards, the number of required parking spaces is 1 space per mobile home plus 10 visitor spaces for the Mobile Home Park.
2. For the purposes of this zone *porch* is defined as a structure abutting a mobile home, having a roof but with walls that are open and unenclosed to the extent of at least 50% thereof and is constructed on piers or a foundation above grade.
3. For the purposes of this zone *deck* is defined as a structure abutting a mobile home with no roof or walls except for visual partitions and railings and is constructed on piers or a foundation above grade.

Section 3.4.144

LAKES DISTRICT COMPREHENSIVE DEVELOPMENT ZONE 44¹

CD44

3.4.144.1 APPLICABILITY OF THE BYLAW

The regulations of Regional District of Nanaimo Land Use and Subdivision Bylaw No. 500, 1987 shall apply to the lands zoned CD44. In addition to these regulations, and where there is a conflict with these regulations, the regulations of the CD44 Zone shall apply.

3.4.144.2 PURPOSE

The purpose of the CD44 Zone is to allow a range of land uses and residential densities with diverse housing types, recreational opportunities, and locally serving commercial services in accordance with Schedule 'B' - Lakes District Neighbourhood Plan in the Nanoose Bay Official Community Plan Bylaw No. 1400, 2005.

The lands encompassed within the CD44 Zone are divided into eight sub-zoning areas including: Regional Park (CD44 - PR1), Community Park (CD44 - PR2), Residential Single Dwelling (CD44 – RS), Residential Single Dwelling & Duplex (CD44 – RSD), Residential Multiple Dwelling (CD44 – RMD), Neighbourhood Mixed Use (CD44 – MU), Lakehouse Centre (CD44 – LC), and Civic Infrastructure (CD44 – CI). Specific regulations apply to each zoning area, in addition to the Definitions and General Regulations as set out in the CD44 Zone.

The extent of each zoning area in the Lakes District Comprehensive Development Zone is shown on Schedule '3A' Zoning Maps of Regional District of Nanaimo Land Use and Subdivision Bylaw No. 500, 1987.

3.4.144.3 DEFINITIONS

artisan workshop means production, service, repair or maintenance of an article, substance, material, fabric or compound, provided uses are not noxious or offensive to the immediate neighbourhood or the general public by reason of emitting odours, dust, gas, noise, effluent, or hazard; and having a gross floor area not exceeding 200 m² including retail sales accessory to the principal use;

bulk grade means the elevation of the surface of the ground at any point within a parcel as established on a parcel contour plan and which may not increase above natural grade by more than 2.0 m at any point;

commercial use means the occupancy or use of a building or land for the purpose of carrying out business, professional activities, artisan workshop, retail or personal service use;

community garden means a non-commercial facility for the cultivation of fruits, flowers, vegetables or ornamental plants;

community park means use of land, buildings or structures primarily for recreation, including playgrounds, band shells, skateboard parks, canoe and kayak docks, boathouses, playfields, field houses, multi-purpose courts and the like;

¹ Bylaw No. 500.384, adopted July 22, 2014

LAKES DISTRICT COMPREHENSIVE DEVELOPMENT ZONE 44 continued

duplex means two self-contained dwelling units with separate ground level entrances, and which are adjoined by a common wall;

height means the elevation of a point directly below:

- a) That part of the building or structure being measured above the land (or surface of water at high water), and;
- b) On a line connecting the two intersections of the natural grade and the outermost exterior walls or supports as indicated on a plan showing any complete vertical section of that part of a building or structure where permitted in the applicable zone; or,
- c) On a line connecting the two intersections of the bulk grade, as defined on a parcel contour plan, and the outermost exterior walls or supports as indicated on a plan showing any complete vertical section of that part of a building within a Residential Single Dwelling & Duplex, Residential Multiple Dwelling, Neighbourhood Mixed Use or Lakehouse Centre zoning area;

garden centre means the use of land, buildings, or structures for the purpose of retail sales of fruits, flowers, vegetables or ornamental plants, trees, and associated gardening and landscaping supplies and outdoor garden equipment;

impermeable surface area means the sum total horizontal area as measured from the outermost perimeter of all buildings or part thereof together with any ground covering that does not naturally exist on the site and cannot be readily penetrated by water, such as roads, paved parking areas, driveways, patios, games courts and the like, on the parcel expressed as a percentage of the total parcel area;

mobile food cart means a mobile cart from which food and/or drink is dispensed, and where the entire stock of goods offered for sale is carried and contained in the cart and which may change locations from time to time, and which is not located in a permanent building or structure, and is removed from public access when not in use;

multiple dwelling unit development means the establishment of three or more dwelling units within a building on a parcel;

natural grade means the elevation of the surface of the ground in its natural state prior to any human-made alterations as determined by a BC Land Surveyor;

nature park means the use of land, buildings or structures primarily for conservation and enjoyment of natural areas and may include boardwalks, trails, environmentally sensitive areas, nature sanctuaries and the like;

parcel contour plan means a survey plan prepared by a BC Land Surveyor or Professional Engineer at minimum 0.5 m contours and showing natural grade and bulk grade of the surface of the ground;

restaurant means an eating establishment providing for the sale of prepared foods and beverages to be consumed on or off the premises, and may include café, delicatessen, and take-out restaurant, but specifically excludes neighbourhood pub, drive-in and drive-thru establishment;

LAKES DISTRICT COMPREHENSIVE DEVELOPMENT ZONE 44 continued

retail store means a sales outlet contained under one roof, having a gross floor area not exceeding 250 m², and providing for the retail sale and display of goods, but specifically excludes industrial uses and gasoline service station;

secondary suite means one or more habitable rooms, but not more than two bedrooms and one cooking facility, constituting a self-contained dwelling unit with a separate entrance, but which is clearly subordinate to the principal dwelling, and is limited to residential use;

seniors' congregate housing means a residential or institutional facility which provides for seniors' congregate housing units with common living facilities, one or more meals per day and housekeeping services, contains a common dining area with a capacity sufficient to accommodate all residents of the facility, and may contain accessory personal service use and accessory convenience store use;

seniors' congregate housing unit means a sleeping unit or a dwelling unit containing one or more sleeping units within a seniors' congregate housing facility;

sleeping unit means a bedroom or other area which is used or intended to be used for sleeping, or sleeping and living purposes, and which does not contain provisions for cooking;

storage means the use of the land, buildings or structures for the temporary storing of property or goods;

storey means that portion of a building situated between the top of any floor and the top of the floor next above it, and if there is no floor above it, that portion between the top of the floor and the ceiling above it;

temporary building means a building which is not supported on permanent foundations and which may or may not be connected to community water or sewer;

tourist accommodation means the rental of a lodging unit in a hotel, motel, or cabin for the temporary accommodation of the traveling public with continuous occupancy not exceeding ninety (90) calendar days and specifically excludes a manufactured home and residential use;

unit density means a measurement of development intensity on a parcel, represented by the total number of dwelling units on a parcel divided by the parcel area in hectares (units per hectare) but excludes dedicated road and dedicated park; and,

utility use means a system of works or services or a facility operated by or on behalf of a government or a utility company to provide or in connection with the provision of water, sewer, drainage, gas, electricity, surface transportation or communication services.

LAKES DISTRICT COMPREHENSIVE DEVELOPMENT ZONE 44 continued

3.4.144.4 GENERAL REGULATIONS

1) Total Number of Dwelling Units

The total number of dwelling units within the lands zoned CD44 shall not exceed 1,675 dwelling units.

2) Uses Permitted in all Zones

The following uses are permitted in all zoning areas of the CD44 Zone:

- a) *Community garden*
- b) *Utility use*

3) Secondary Suites

Secondary suites are permitted in the *Residential Single Dwelling* and *Residential Single Dwelling & Duplex* zoning areas, provided that:

- a) A *secondary suite* is permitted only within a principal single dwelling unit on a parcel and is not permitted within a *duplex*;
- b) Not more than one *secondary suite* shall be permitted per single dwelling unit on a parcel;
- c) The size of a *secondary suite* within the principal building shall not exceed 40% of the habitable floor space of the principal building to a maximum of 90 m²;
- d) Secondary suites are not counted as dwelling units for the purpose of calculating the Total Number of Dwelling Units in accordance with the General Regulations Section 3.4.144.4 1) in this Zone;
- e) A principal dwelling unit may contain either a *secondary suite* or a bed and breakfast, but not both; and,
- f) A minimum of one off-street parking space is required for a *secondary suite*, in addition to parking requirements for the principal dwelling unit set out in Schedule '3B' Off-Street Parking and Loading Spaces.

4) Rainwater Harvesting

Where a Building Permit is not required for rainwater harvesting structures, equipment and apparatus, including rain barrels and cisterns, they are excluded from the building setback requirements.

5) Seniors' Congregate Housing

Seniors' congregate housing, where permitted in the zone, is subject to the following regulations:

- a) For the purposes of calculating unit density, each *sleeping unit*, and each *sleeping unit* within a dwelling unit within a seniors' congregate housing facility is equal to 0.2 units;
- b) The gross floor area of a *seniors' congregate housing unit* shall not be less than 26 m² and not more than 50 m²; and

LAKES DISTRICT COMPREHENSIVE DEVELOPMENT ZONE 44 continued

- c) Accessory personal service and convenience store uses, where provided, shall be contained within the seniors' congregate housing facility and shall be accessible only from an internal hallway or corridor. The combined total floor area of all accessory personal service and convenience store uses shall not exceed 150 m² per seniors' congregate housing facility.

6) Temporary Buildings, Structures and Uses for Seasonal Vending

Temporary buildings, structures, or mobile food carts for the purpose of seasonal vending on properties are permitted within any regional park, community park, and commercially zoned properties provided that:

- a) The parking requirements of Schedule '3B' Off-Street Parking and Loading Spaces are met; and,
- b) Potable water and washroom facilities are available on-site if food is served.

7) Tourist Accommodation

Temporary stays within *tourist accommodation* is limited to a maximum consecutive or non-consecutive stay of ninety (90) calendar days per visitor in any twelve (12) month period within any tourist accommodation unit on a parcel. The relocation of a visitor to another unit within the parcel does not constitute the start of a new stay.

8) Building Height

The following regulations apply to building height within all zoning areas of the CD44 Zone:

- a) A *parcel contour plan* defining areas where natural grade has been disturbed shall be submitted to the Regional District upon the earlier of the submission of a development permit application or prior to registration of a subdivision plan.
- b) Structures such as antennae, chimney stacks, steeples, elevator housings, roof stairway entrances, ventilating equipment or enclosures for such equipment, skylights, flagpoles and the like are exempt from the height requirement.
- c) Structures for sustainable building technologies, such as wind turbines, solar panels and rain barrels, cisterns and the like are permitted to exceed the height requirement provided that:
 - i) No such structure covers more than 20% of the parcel area; or
 - ii) If located on a building, no such structure covers more than 10% of the roof area; and,
 - iii) No such structure shall exceed twice the maximum building height permitted by the zone.

9) Storage

Storage use, where permitted in the zone, is subject to the following regulations:

- a) Boats, vehicles and recreational vehicles must be operational and capable of being licensed by the applicable licensing authority. Storage use excludes on-site fuel dispensing.

LAKES DISTRICT COMPREHENSIVE DEVELOPMENT ZONE 44 continued

- b) Storage is accessory to the principal use and is limited to 33% of a parcel area.
- c) A continuous landscaping buffer with a minimum vegetation height of 2.0 m and width of 2.0 m shall be provided and maintained along all property lines adjacent to a storage use.

3.4.144.5 REGIONAL PARK

CD44 – PR1

Purpose

The intent of the Regional Park zoning area is to provide recreational opportunities associated with passive outdoor activities, and to protect the natural features and wildlife habitat that form an integral part of the landscape in the Lakes District neighbourhood.

Permitted Principal Uses

- a) nature park

Maximum Size of Buildings and Structures

Height	6.0 m within the setback area 9.5 m outside the setback area
Parcel coverage	10%

Minimum Setback Requirements

- a) Buildings
 - Front lot line 4.5 m
 - Exterior side lot line 4.5 m
 - All other lot lines 3.0 m

- b) Structures
 - Front lot line 0.0 m
 - All other lot lines 3.0 m

Off-Street Parking Requirements

Major staging area	10 spaces
Minor staging area	4 spaces
Bicycle parking	4 spaces per major or minor staging area

3.4.144.6 COMMUNITY PARK

CD44 – PR2

Purpose

The intent of the Community Park zoning area is to provide programmed park spaces and recreational opportunities and amenities for social gathering and outdoor activities in close proximity to residential neighbourhoods.

Permitted Principal Uses

- a) community park

Maximum Size of Buildings and Structures

Height	6.0 m within the setback area 9.5 m outside the setback area
--------	---

Parcel coverage	20%
-----------------	-----

Minimum Setback Requirements

- a) Buildings
 - Front lot line 4.5 m
 - Exterior side lot line 4.5 m
 - All other lot lines 3.0 m

- b) Structures
 - Front lot line 0.0 m
 - All other lot lines 3.0 m

Off-Street Parking Requirements

Bicycle parking	6 spaces per parcel
-----------------	---------------------

3.4.144.7 RESIDENTIAL SINGLE DWELLING

CD44 – RS

Purpose

The Residential Single Dwelling zoning area allows residential development on larger urban lots and provides flexibility in building siting for the retention of natural site features and a range of architectural forms.

Permitted Principal Uses

- a) residential use

Accessory Uses

- a) home based business
- b) secondary suite

Maximum Density

Residential use	1 dwelling unit per parcel
-----------------	----------------------------

Minimum Parcel Size

800 m² or 850 m² (corner parcel)

Maximum Size of Buildings and Structures

Height	
Principal building	9.5 m
Accessory buildings & structures	6.0 m
Parcel Coverage	40%
Impermeable Surface Area	50% (excluding a driveway not exceeding 6.0 m in width and located within a panhandle)

Minimum Setback Requirements

Front lot line	4.5 m 6.0 m to any garage door or carport entrance way facing a highway.
Interior side lot line	2.0 m
Exterior side lot line	4.5 m
Rear lot line	4.0 m

except one accessory building is permitted to be 1.0 m from an interior or rear lot line provided the building does not exceed 10 m² in floor area and 3.0 m in height.

3.4.144.8 RESIDENTIAL SINGLE DWELLING & DUPLEX**CD44 – RSD****Purpose**

The intent of the Residential Single Dwelling & Duplex zoning area is to increase the range of housing types offered and provide transition between larger lot single dwelling residential land uses and low to medium density housing. The provision of smaller single dwelling units and duplex homes serves to facilitate cluster development to maintain high conservation and recreation value in the adjacent areas.

Permitted Principal Uses

- a) residential use
- b) duplex use

Accessory Uses

- a) home based business
- b) secondary suite

Maximum Density

Residential use	1 dwelling unit per parcel
Duplex use	2 dwelling units per parcel

Minimum Parcel Size

Residential use	400 m ² or 450 m ² (corner parcel)
Duplex use	750 m ² or 800 m ² (corner parcel)

Maximum Size of Buildings and Structures

Height	
Principal building	9.5 m
Accessory buildings & structures	6.0 m
Parcel Coverage	
Residential use	60%
Duplex use	65%
Impermeable Surface Area	
Residential use	70% (excluding a driveway not exceeding 6.0 m in width and located within a panhandle)
Duplex use	75% (excluding a driveway not exceeding 6.0 m in width and located within a panhandle)

3.4.144.8 RESIDENTIAL SINGLE DWELLING & DUPLEX continued

Minimum Setback Requirements

a) Residential use	
Front lot line	4.5 m 6.0 m to any garage door or carport entrance way facing a highway.
Interior side lot line	1.5 m
Exterior side lot line	4.5 m
Rear lot line	3.0 m
b) Duplex use	
Front lot line	4.5 m 6.0 m to any garage door or carport entrance way facing a highway.
Interior side lot line	2.0 m
Exterior side lot line	4.5 m
Rear lot line	4.0 m for a duplex
Strata road	3.0 m

except one accessory building per principal dwelling unit is permitted to be 1.0 m from an interior or rear lot line provided the building does not exceed 10 m² in floor area and 3.0 m in height.

3.4.144.9 RESIDENTIAL MULTIPLE DWELLING**CD44 – RMD****Purpose**

The Residential Multiple Dwelling zoning area allows for the development of a range of multiple dwelling housing types including duplexes, ground-oriented rowhomes and townhomes, and low-rise condominium buildings. These smaller unit types are intended to provide opportunities for ageing-in-place.

Permitted Principal Uses

- a) duplex use
- b) multiple dwelling unit development use

Maximum Density

Density	75 units per hectare (uph)
---------	----------------------------

Minimum Parcel Size

Duplex use	600 m ² or 650 m ² (corner parcel)
Multiple dwelling unit Development use	700 m ² or 750 m ² (corner parcel)

Maximum Size of Buildings and Structures

Height	
Duplex	9.5 m
Multiple dwelling unit development	21.0 m or 5 storeys, whichever is less
Accessory buildings & structures	6.0 m 8.5 m for one accessory building in a multiple dwelling unit development
Parcel Coverage	
	60%
	70% where the required parking spaces are located directly beneath the principal building.
Impermeable Surface Area	
	70%
	75% where the required parking spaces are located directly beneath the principal building (excluding a driveway not exceeding 6.0 m in width and located within a panhandle).

3.4.144.9 RESIDENTIAL MULTIPLE DWELLING continued

Minimum Setback Requirements

Front lot line	4.5 m 6.0 m to any garage door or carport entrance way facing a highway.
Interior side lot line	2.0 m
Exterior side lot line	4.5 m
Rear lot line	4.0 m
Strata road	3.0 m

except one accessory building per principal dwelling unit is permitted to be 1.0 m from an interior or rear lot line provided the building does not exceed 10 m² in floor area and 3.0 m in height.

Off-Street Parking Requirements

In addition to the requirements of Schedule '3B' Off-Street Parking & Loading Spaces, the following bicycle parking is required:

Use	Required Bicycle Parking Spaces
Multiple dwelling unit development use	1 secure interior space per 2 dwelling units, and 4 spaces adjacent to the primary building entrance.

3.4.144.10 NEIGHBOURHOOD MIXED USE**CD44 – MU****Purpose**

As a complement to the existing commercial centres at Red Gap and Schooner Cove, the Neighbourhood Mixed Use zoning area is intended to accommodate locally serving civic, commercial and residential uses at the entrance of the Lakes District neighbourhood. A mix of small scale retail, professional office use, live/work, compact housing and other compatible uses will provide community gathering spaces with flexibility to accommodate the future needs of the community.

Permitted Principal Uses

- a) artisan workshop
- b) garden centre
- c) multiple dwelling unit development
- d) office
- e) personal care
- f) personal service use
- g) retail store
- h) restaurant
- i) school
- j) seniors' congregate housing
- k) tourist accommodation

Accessory Uses

- a) storage

Maximum Density

Density	75 units per hectare (uph) for residential uses
---------	---

Minimum Parcel Size

Commercial / Mixed use	2,500 m ²
Multiple dwelling unit development use	700 m ² or 750 m ² (corner parcel)

Maximum Size of Buildings and Structures**Height**

Commercial use	10.0 m or 3 storeys, whichever is less
Mixed use or Multiple dwelling unit development	21.0 m or 5 storeys, whichever is less

3.4.144.10 NEIGHBOURHOOD MIXED USE continued

Accessory buildings & structures	6.0 m 8.5 m for one accessory building in a multiple dwelling unit development
Parcel Coverage	70% 80% where the required parking spaces are located directly beneath the principal building.
Impermeable Surface Area	80% 85% where the required parking spaces are located directly beneath the principal building (excluding a driveway not exceeding 6.0 m in width and located within a panhandle). 75% for storage use only

Minimum Setback Requirements

a) Commercial	Lot lines fronting a highway 4.5 m All other lot lines 0.0 m
b) Residential or Mixed use:	Front lot line 4.5 m 6.0 m to any garage door or carport entrance way facing a highway. Interior side lot line 2.0 m Exterior side lot line 4.5 m Rear lot line 4.0 m Strata road 3.0 m

except one accessory building is permitted to be 1.0 m from an interior or rear lot line provided the building does not exceed 10 m² in floor area and 3.0 m in height.

Off-Street Parking Requirements

Seniors' congregate housing 1 space per 2 employees and 1 per 5 beds

For other uses permitted in this zone, parking shall be provided as set out under Schedule '3B' Off-Street Parking & Loading Spaces.

In addition to the requirements of Schedule '3B' Off-Street Parking & Loading Spaces, the following bicycle parking is required:

3.4.144.10 NEIGHBOURHOOD MIXED USE continued

Use	Required Bicycle Parking Spaces
Commercial use	1 space per 475 m ² commercial floor area adjacent to primary building entrances.
Multiple dwelling unit development use	1 secure interior space per 2 dwelling units, and 4 spaces adjacent to the primary building entrance.
Seniors' congregate housing	1 secure interior space per 10 employees.

Other Regulations

- a) No single use may occupy more than 80% of the total building floor area within a parcel.
- b) Commercial use on the ground floor of a building is only permitted where an additional storey is provided above.

3.4.144.11 LAKEHOUSE CENTRE

CD44 – LC

Purpose

The intent of the Lakehouse Centre zoning area is to allow a commercial recreational centre in the Lakes District community adjacent to Enos Lake park and trails. This privately operated facility may also be used to accommodate Lakes District regional park administration and limited programs for regional park staging as well as some tourist accommodation and other compatible accessory uses.

Permitted Principal Uses

- a) assembly use
- b) recreational facility

Accessory Uses

- a) convenience store
- b) inn
- c) office
- d) personal care
- e) personal service use
- f) restaurant
- g) retail store
- h) school
- i) theatre
- j) tourist accommodation
- k) tourist information booth
- l) tourist store

Maximum Density

Density 12 units per hectare (uph) for tourist accommodation

Minimum Parcel Size

9,000 m²

Maximum Size of Buildings and Structures

Height	
Principal building	10.0 m
Accessory buildings & structures	6.0 m

3.4.144.11 LAKEHOUSE CENTRE continued

Parcel Coverage	40%
Impermeable Surface Area	50%

Minimum Setback Requirements

All lot lines	6.0m
---------------	------

Off-Street Parking Requirements

In addition to the requirements of Schedule '3B' Off-Street Parking & Loading Spaces, the following parking is required:

Bicycle parking	1 space 95 m ² floor area
-----------------	--------------------------------------

3.4.144.12 CIVIC INFRASTRUCTURE

CD44 – CI

Purpose

The Civic Infrastructure zoning area allows for community servicing infrastructure and utilities, specifically related the provision of potable water and sanitary sewer servicing and rainwater management.

Permitted Principal Uses

- a) utility use

Maximum Size of Buildings and Structures

Height	10.0m
Parcel coverage	25%

Minimum Setback Requirements

All lot lines	6.0m
---------------	------

Other Regulations

Notwithstanding Schedule '3F' Landscaping Regulations and Standards, Section 3.2.1, a minimum 3.0m wide landscape buffer shall be provided within the setback area of a parcel adjacent to a highway or residential use where buildings or structures are proposed for utility use.

Section 3.4.145

SCHOONER COVE COMPREHENSIVE DEVELOPMENT ZONE 45¹

CD45

3.4.145.1 APPLICABILITY OF THE BYLAW

The regulations of Regional District of Nanaimo Land Use and Subdivision Bylaw No. 500, 1987 shall apply to the lands zoned CD45. In addition to these regulations, and where there is a conflict with these regulations, the regulations of the CD45 Zone shall apply.

3.4.145.2 PURPOSE

The purpose of the CD45 Zone is to allow a mixed-use waterfront village with neighbourhood-oriented commercial shops and services, a marina, a range of multiple dwelling housing types, and a publicly accessible network of waterfront boardwalks, plazas, and pathways in accordance with Schedule 'C' – Schooner Cove Neighbourhood Plan in the Nanoose Bay Official Community Plan Bylaw No. 1400, 2005.

The lands encompassed within the CD45 Zone are divided into three sub-zoning areas including: Village Mixed Use (CD45 – MU), Marina (CD45 – MA), and Residential Multiple Dwelling (CD45 – RMD). Specific regulations apply to each zoning area, in addition to the Definitions and General Regulations as set out in the CD45 Zone.

The extent of each zoning area in the Lakes District Comprehensive Development Zone is shown on Schedule '3A' Zoning Maps of Regional District of Nanaimo Land Use and Subdivision Bylaw No. 500, 1987.

3.4.145.3 DEFINITIONS

assembly use means the use of land, buildings or structures to accommodate exhibits, special events or meetings and includes auditorium, church, museum, community hall, fraternal lodge, youth centre, theatre;

artisan workshop means production, service, repair or maintenance of an article, substance, material, fabric or compound, provided uses are not noxious or offensive to the immediate neighbourhood or the general public by reason of emitting odours, dust, gas, noise, effluent, or hazard; and having a gross floor area not exceeding 200 m² including retail sales accessory to the principal use;

boat launching facility means jib crane hoist, boat ramp or other means to launch and/or retrieve watercraft;

commercial parking means use of land, buildings and structures for the purpose of providing short-term commercial parking spaces;

commercial use means the occupancy or use of a building or land for the purpose of carrying out business, professional activities, artisan workshop, retail or personal service use;

community garden means a non-commercial facility for the cultivation of fruits, flowers, vegetables or ornamental plants;

geodetic elevation means the vertical elevation or height of a given point on land or above the surface of the water measured from the geodetic datum as determined by a BC Land Surveyor;

¹ Bylaw No. 500.385, adopted July 22, 2014

SCHOONER COVE COMPREHENSIVE DEVELOPMENT ZONE 45¹ continued

grocery store means a sales outlet contained under one roof, having a gross floor area not exceeding 750 m², and providing for the retail sale and display of food and related goods;

height means that part of a building or structure measured above the geodetic datum as determined by a BC Land Surveyor to the outermost exterior walls or supports as indicated on a plan showing any complete vertical section of that part of a building or structure where permitted in the applicable zone;

impermeable surface area means the sum total horizontal area as measured from the outermost perimeter of all buildings or part thereof together with any ground covering that does not naturally exist on the site and cannot be readily penetrated by water, such as roads, paved parking areas, driveways, patios, games courts and the like, on the parcel expressed as a percentage of the total parcel area;

liquor store means a retail store licensed under the Liquor Control and Licensing Act, and amendments thereto, for the sale of beer, wine and other alcoholic beverages;

live/work unit means the use of a building or portion thereof for an economic activity including artisan workshop, personal service use or office in combination with a dwelling unit;

marina means moorage, boat launching facilities, and outdoor recreation use, including the rental and maintenance of boats and seaplanes, and which may be equipped with administration facilities, washrooms, showers and refuse disposal facilities;

mobile food cart means a mobile cart from which food and/or drink is dispensed, and where the entire stock of goods offered for sale is carried and contained in the cart and which may change locations from time to time, and which is not located in a permanent building or structure, and is removed from public access when not in use;

multiple dwelling unit development means the establishment of three or more dwelling units within a building on a parcel;

neighbourhood pub means an establishment with a liquor primary licence issued pursuant to the Liquor Control and Licensing Act and amendments thereto;

resort condominium development means a hotel and includes hotel units subdivided pursuant to the Strata Property Act and amendments thereto, with continuous occupancy not exceeding ninety (90) calendar days and does not include residential use;

restaurant means an eating establishment providing for the sale of prepared foods and beverages to be consumed on or off the premises, and may include café, delicatessen, and take-out restaurant but specifically excludes neighbourhood pub, drive-in and drive-thru establishment;

retail store means a sales outlet contained under one roof, having a gross floor area not exceeding 250 m², and providing for the retail sale and display of goods, but specifically excludes industrial uses and gasoline service station;

seniors' congregate housing means a residential or institutional facility which provides for seniors' congregate housing units with common living facilities, one or more meals per day and housekeeping services, contains a common dining area with a capacity sufficient to accommodate

¹ Bylaw No. 500.385, adopted July 22, 2014

SCHOONER COVE COMPREHENSIVE DEVELOPMENT ZONE 45¹ continued

all residents of the facility, and may contain accessory personal service use and accessory convenience store use;

seniors' congregate housing unit means a sleeping unit or a dwelling unit containing one or more sleeping units within a seniors' congregate housing facility;

sleeping unit means a bedroom or other area which is used or intended to be used for sleeping, or sleeping and living purposes, and which does not contain provisions for cooking;

storey means that portion of a building situated between the top of any floor and the top of the floor next above it, and if there is no floor above it, that portion between the top of the floor and the ceiling above it;

temporary building means a building which is not supported on permanent foundations and which may or may not be connected to community water or sewer;

tourist accommodation means the rental of a lodging unit in a hotel, motel, and cabin for the temporary accommodation of the traveling public with continuous occupancy not exceeding ninety (90) calendar days and specifically excludes a manufactured home and residential use; and,

unit density means a measurement of development intensity on a parcel, represented by the total number of dwelling units on a parcel divided by the parcel area in hectares (units per hectare) but excludes dedicated road and dedicated park.

¹ Bylaw No. 500.385, adopted July 22, 2014

3.4.145.4 GENERAL REGULATIONS

1) Total Number of Dwelling Units

The total number of dwelling units within the lands zoned CD45 shall not exceed 360 dwelling units.

2) Uses Permitted in all Zones

The following uses are permitted in all zoning areas of the CD45 Zone:

- a) *Community garden*

3) Rainwater Harvesting

Where a Building Permit is not required for rainwater harvesting structures, equipment and apparatus, including rain barrels and cisterns, they are excluded from the building setback requirements.

4) Seniors' Congregate Housing

Seniors' congregate housing, where permitted in the zone, is subject to the following regulations:

- a) For the purposes of calculating unit density, each *sleeping unit*, and each *sleeping unit* within a dwelling unit within a seniors' congregate housing facility is equal to 0.2 units;
- b) The gross floor area of a *seniors' congregate housing unit* shall not be less than 26 m² and not more than 50 m²; and
- c) Accessory personal service and convenience store uses, where provided, shall be contained within the seniors' congregate housing facility and shall be accessible only from an internal hallway or corridor. The combined total floor area of all accessory personal service and convenience store uses shall not exceed 150 m² per seniors' congregate housing facility.

5) Temporary Buildings, Structures and Uses for Seasonal Vending

Temporary buildings, structures, or mobile food carts for the purpose of seasonal vending on properties are permitted within any commercially zoned properties provided that potable water and washroom facilities are available on-site if food is served.

6) Resort Condominium and Tourist Accommodation

Temporary stays within *resort condominium development* or *tourist accommodation* is limited to a maximum consecutive or non-consecutive stay of ninety (90) calendar days per visitor in any twelve (12) month period within any resort condominium or tourist accommodation unit on a parcel. The relocation of a visitor to another unit within the parcel does not constitute the start of a new stay.

7) Building Height

The following regulations apply to building height within all zoning areas of the CD45 Zone:

- a) Structures such as antennae, chimney stacks, steeples, elevator housings, roof stairway entrances, ventilating equipment or enclosures for such equipment, skylights, flagpoles and the like are exempt from the height requirement.
- b) Structures for sustainable building technologies, such as solar panels and rain barrels, cisterns and the like are permitted to exceed the height requirement provided that:
 - i) No such structure covers more than 20% of the parcel area; or
 - ii) If located on a building, no such structure covers more than 10% of the roof area; and,
 - iii) No such structure shall exceed twice the maximum building height permitted by the zone.
- c) Notwithstanding 7 b) above, wind turbines in Area 'A' shall not exceed the maximum permitted building height in as shown on Schedule 1 of the CD45 Zone.

3.4.145.5

VILLAGE MIXED USE

CD45 – MU

Purpose

The intent of the Schooner Cove Village Mixed Use zoning area is to establish a vibrant commercial and civic core with a pedestrian-oriented village on the waterfront and ground-oriented commercial uses such as restaurants, shops and services with residential uses above.

Permitted Principal Uses

- a) artisan workshop
- b) assembly use
- c) grocery store
- d) office
- e) liquor store
- f) live/work
- g) multiple dwelling unit development use
- h) neighbourhood pub
- i) outdoor recreation
- j) personal service use
- k) recreation facility
- l) resort condominium development use
- m) restaurant
- n) retail store
- o) seniors' congregate care
- p) tourist accommodation

Accessory Uses

- a) commercial parking
- b) marina sales
- c) tourist information booth

Maximum Density

Maximum 50 dwelling units permitted in the CD45 – MU Zone.

3.4.145.5 VILLAGE MIXED USE continued

Minimum Parcel Size

Commercial / mixed use	900 m ²
Multiple dwelling unit development	2,000 m ²

Maximum Size of Buildings and Structures

The maximum permitted building height shall be as shown on **Schedule 1 Maximum Building Height Plan** in the CD45 Zone and as summarized below:

Height

Principal buildings

Area B	18.0 m geodetic elevation or 3 storeys, whichever is less
Area C	22.0 m geodetic elevation or 3 storeys, whichever is less
Area D	26.1 m geodetic elevation or 5 storeys, whichever is less
Area E	31.0 m geodetic elevation or 5 storeys, whichever is less

Accessory buildings

Area D	One accessory building is permitted to a height of 2 storeys, provided that a storey does not exceed 5.0 m.
--------	---

Maximum Floor Area	Total combined floor area for non-residential uses shall not exceed 2,325 m ² .
--------------------	--

Parcel Coverage	70%
	80% where the required parking spaces are located directly beneath the principal building.

Impermeable Surface Area	80%
	85% where the required parking spaces are located directly beneath the principal building.

Minimum Setback Requirements

- | | |
|--|-------|
| a) Lot lines fronting a highway | 4.5 m |
| b) Lot lines that are common with Lot B, District Lot 78, Nanoose District Strata Plan 745 | 4.5 m |
| c) All other lot lines | 0.0 m |

3.4.145.5 VILLAGE MIXED USE continued

- d) Notwithstanding Section 3.3.9 b) Setbacks - Sea for Electoral Area 'E', a 0.0 m setback for buildings is permitted for up to a maximum of 35 percent of the length of the parcel boundary that is common to the sea.
- e) Notwithstanding Section 3.3.9 b) Setbacks - Sea for Electoral Area 'E', a 0.0 m setback is permitted for structures.

Off-Street Parking Requirements

Seniors' congregate housing	1 space per 2 employees and 1 per 5 beds
Commercial use, restaurant use, neighbourhood pub use	74 spaces in total, plus 1 space per 3 seats where a restaurant or neighbourhood pub exceeds 100 seats.

For other uses permitted in this zone, parking shall be provided as set out under Schedule '3B' Off-Street Parking & Loading Spaces.

In addition to the requirements of Schedule '3B' Off-Street Parking & Loading Spaces, the following bicycle parking is required:

Use	Required Bicycle Parking Spaces
Commercial use, restaurant use, neighbourhood pub use	1 space per 475 m ² commercial floor area adjacent to primary building entrances.
Multiple dwelling unit development use	1 secure interior space per 2 dwelling units, and 4 spaces adjacent to the primary building entrance.
Seniors' congregate housing	1 secure interior space per 10 employees.

Other Regulations

- a) Non-residential uses shall comprise at least 20% of the total building floor area within a parcel.
- b) A maximum of one grocery store is permitted within the Village Mixed Use Zone.
- c) Notwithstanding Schedule '3F' Landscaping Regulations and Standards, Section 2.1.1 a landscape buffer is not required for a designated highway adjacent to a commercial use and multiple dwelling unit development.

3.4.145.6

MARINA

CD45 – MA

Purpose

The intent of the Marina zoning area is to allow the operation of a marina business including a moorage, marina office, marine fuel supply station, and other ancillary marina services and facilities.

Permitted Principal Uses

- a) boat launching facility
- b) marina use

Accessory Uses

- a) convenience store
- b) marina fuel supply station
- c) marina sales

Maximum Size of Buildings and Structures

The maximum permitted building height shall be as shown on **Schedule 1 Maximum Building Height Plan** in the CD45 Zone and as summarized below:

Height	
Area A	7.0 m geodetic elevation or 1 storey, whichever is less, notwithstanding floating buildings and structures shall be measured from the surface of the water.
Parcel Coverage	5% provided that no individual building covers more than 1% of a parcel.

Minimum Setback Requirements

Notwithstanding Section 3.3.9 b) Setbacks - Sea for Electoral Area 'E', a 0.0 m setback is permitted for buildings and structures.

Off-Street Parking Requirements

Marina use	1 parking space per 4 marina slips
Boat launching facility	20 boat trailer parking spaces

For other uses permitted in this zone, parking shall be provided as set out under Schedule '3B' Off-Street Parking & Loading Spaces.

A minimum of 25% of the parking required for marina use in the CD45 – MA Zone shall be provided within the lands zoned CD45 – MU and a maximum of 75% of the marina parking

3.4.145.6 MARINA continued

may be provided within the lands zoned CD45 – RMD, provided that none of the required off-street parking is located within a highway.

The off-street parking required for a *boat launching facility* shall be provided within the lands zoned CD45 – RMD.

In addition to the requirements of Schedule ‘3B’ Off-Street Parking & Loading Spaces, the following bicycle parking is required:

Use	Required Bicycle Parking Spaces
Marina use	8 spaces

3.4.145.7

RESIDENTIAL MULTIPLE DWELLING

CD45 – RMD

Purpose

The Residential Multiple Dwelling zoning area allows for the development of multiple dwelling housing types including ground-oriented and low-rise condominium buildings. These smaller unit types are intended to provide opportunities for downsizing and ageing-in-place in close proximity to publically-accessible open space and village commercial uses.

Permitted Principal Uses

- a) commercial parking
- b) multiple dwelling unit development use
- c) seniors' congregate housing

Maximum Density

Maximum 310 dwelling units permitted in the CD45 – RMD Zone

Minimum Parcel Size

Multiple dwelling unit development	2,000 m ²
------------------------------------	----------------------

Maximum Size of Buildings and Structures

The maximum permitted building height shall be as shown on **Schedule 1 Maximum Building Height Plan** in the CD45 Zone and as summarized below:

Height

Principal buildings

- | | |
|--------|---|
| Area D | 26.1 m geodetic elevation or 5 storeys, whichever is less |
| Area F | 37.0 m geodetic elevation or 5 storeys, whichever is less |
| Area G | 42.0 m geodetic elevation or 5 storeys, whichever is less |

Accessory buildings

- | | |
|--------|--|
| Area D | One accessory building is permitted to a height of 2 storeys, and all other accessory buildings shall not exceed 1 storey, provided that a storey does not exceed 5.0 m. |
| Area F | One accessory building is permitted to a height of 2 storeys, and all other accessory buildings shall not exceed 1 storey, provided that a storey does not exceed 5.0 m. |
| Area G | One accessory building is permitted to a height of 2 storeys, and all other accessory buildings shall not exceed 1 storey, provided that a storey does not exceed 5.0 m. |

3.4.145.7 RESIDENTIAL MULTIPLE DWELLING continued

Parcel Coverage	60%
	70% where the required parking spaces are located directly beneath the principal building.
Impermeable Surface Area	80%
	85% where the required parking spaces are located directly beneath the principal building.

Minimum Setback Requirements

All lot lines	5.0 m
---------------	-------

Off-Street Parking Requirements

Seniors' congregate housing	1 space per 2 employees and 1 per 5 beds
-----------------------------	--

For other uses permitted in this zone, parking shall be provided as set out under Schedule '3B' Off-Street Parking & Loading Spaces.

In addition to the requirements of Schedule '3B' Off-Street Parking & Loading Spaces, the following bicycle parking is required:

Use	Required Bicycle Parking Spaces
Multiple dwelling unit development use	1 secure interior space per 2 dwelling units, and 4 spaces adjacent to the primary building entrance.

Seniors' congregate housing 1 secure interior space per 10 employees.

Other Regulations

Notwithstanding Schedule '3F' Landscaping Regulations and Standards, Section 3.2.1, a minimum 3.0m wide landscape buffer shall be provided within the setback area of a parcel adjacent to a highway for a multiple dwelling unit development.

Schooner Cove Comprehensive Development Zone CD45 Schedule 1 Maximum Building Height Plan

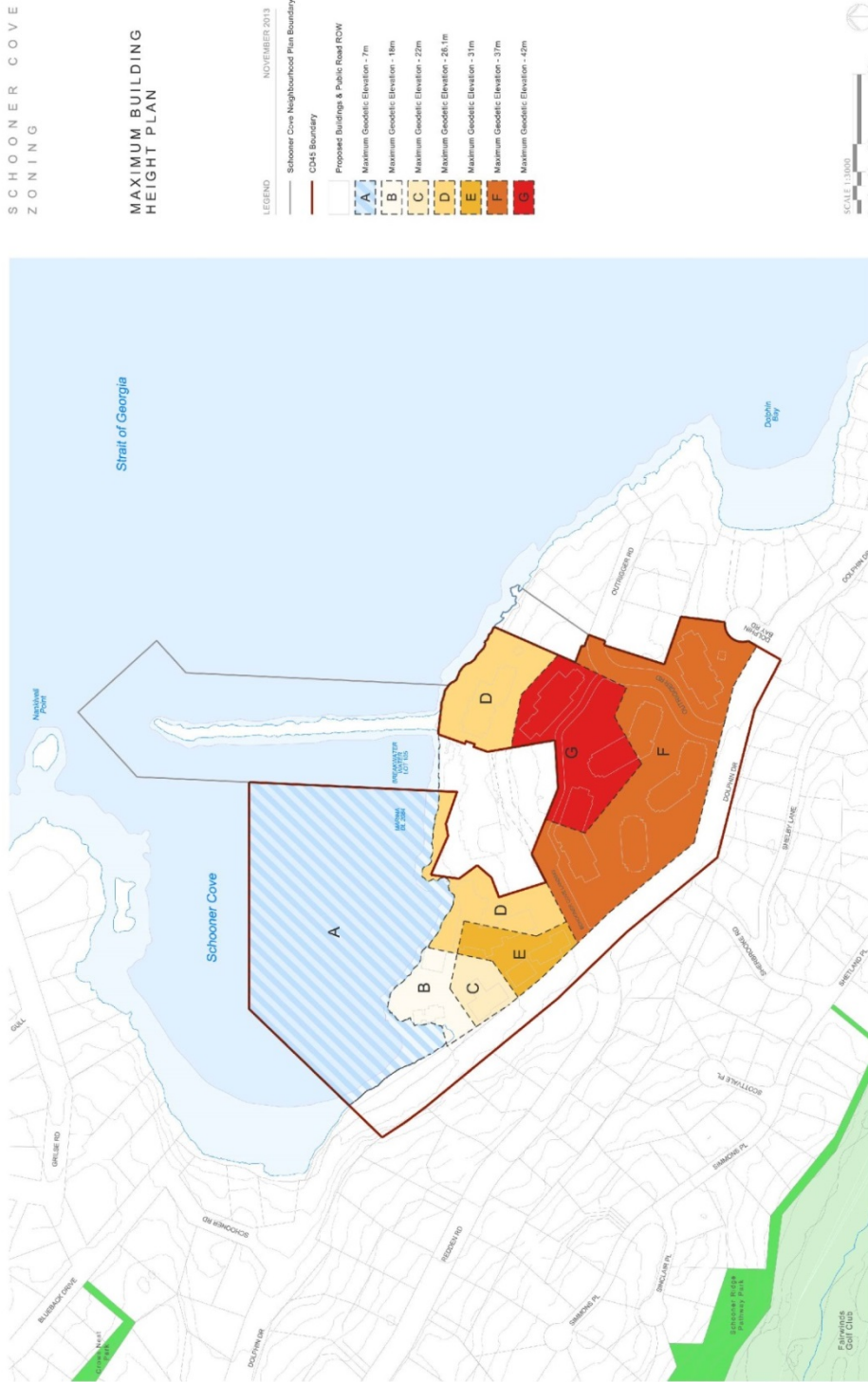

Section 3.4.149

FIELDING ROAD LIGHT INDUSTRIAL COMPREHENSIVE DEVELOPMENT ZONE 49¹

CD49

3.4.149.1 Permitted Principal Uses

- a) Heavy Equipment Display
- b) Light Industry
- c) Manufacturing
- d) Residential Use

3.4.149.2 Permitted Accessory Uses

- a) Marshalling Yard
-

3.4.149.3 Maximum Number and Size of Buildings and Structures

Dwelling units/parcel	1
Height	9.0 m
Parcel coverage	40%

3.4.149.4 Minimum Setback Requirements

Front lot line	4.5 m
Other Lot Lines	5.0 m

except where:

- a) the adjoining parcel is zoned industrial or commercial then the setback from the common interior side lot line may be reduced to zero.
-

3.4.149.5 Other Regulations

For the purpose of this zone:

- a) Manufacturing means the assembling, producing, inspecting, finishing, altering, servicing, and repairing of any goods, substance, article, or materials, and must be contained within a building and may include accessory office use and accessory retail sales of the product(s) produced, up to a maximum of 10% of the floor area of a building.
- b) For the purposes of this zone, notwithstanding Schedule '3B', Off-Street Parking & Loading Spaces, the minimum number of required parking spaces is 1 per 115 m² of floor area plus 1 loading space per building.

¹ Bylaw No. 500.392, adopted February 24, 2015

Comprehensive Development Zone CD49
Schedule 1

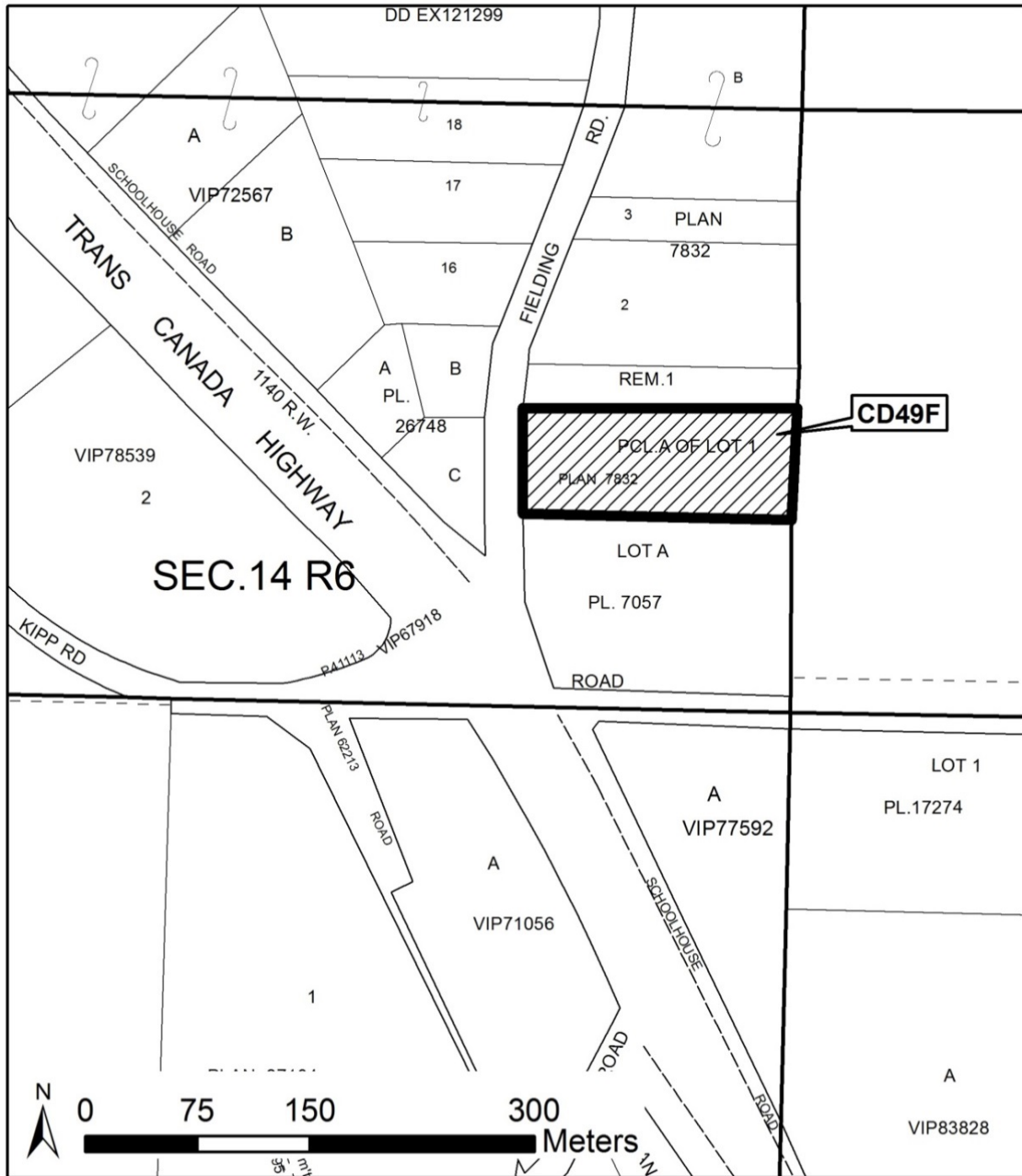

Section 3.4.150

BECK ROAD COMPREHENSIVE DEVELOPMENT ZONE 50¹

CD50

3.4.150.1 Permitted Uses

Permitted Uses

- a) Neighbourhood Pub
 - b) Residential Use
 - c) Restaurant
 - d) Tourist Information Booth
 - e) Tourist Store
-

3.4.150.2 Maximum Number and Size of Buildings and Structures

Dwelling units/parcel	1
Floor Area Ratio	0.40
Height	10.0 m
Parcel coverage	40%

3.4.150.3 Minimum Setback Requirements

For all buildings and structures unless otherwise set out in Part 3 Land Use Regulations:

Front lot line	8.0 m
Other lot lines	5.0 m

¹ Bylaw No. 500.397, adopted May 26, 2015

Comprehensive Development Zone CD50
Schedule 1

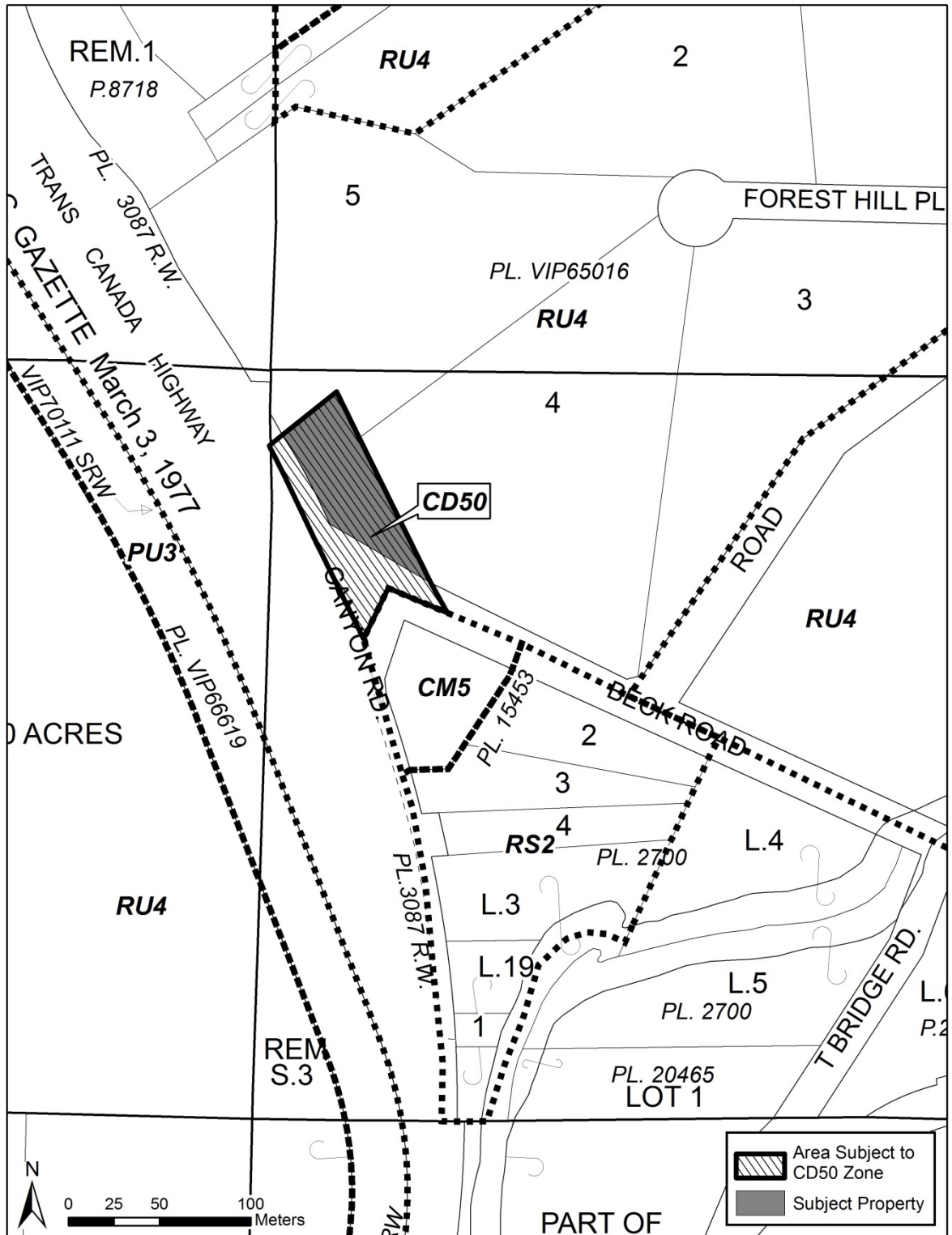

Section 3.4.151

COMPREHENSIVE DEVELOPMENT ZONE 51

CD51¹

3.4.151.1 Permitted Uses & Minimum Site Area

Permitted Uses	Required Site Area with:		
	Community Water & Sewer System	Community Water System	No Community Services
a) Multiple Dwelling Unit Development:			
- per dwelling unit	500 m ²	1600 m ²	1.0 ha
b) Home Based Business	N/A	N/A	N/A

3.4.151.2 Maximum Number and Size of Buildings and Structures

Height	9.0 m
Parcel coverage	35%

3.4.151.3 Minimum Setback Requirements

Lots lines fronting the Island Highway	10.0 m
Front and Exterior side lot line	6.0 m
Interior side and rear lot line	3.0 m
Phased Strata lot line	0.0 m

Except:

- a) one dwelling unit is permitted to be 2.0 metres from an exterior side lot line or front lot line.
- b) where any part of a parcel is adjacent to or contains a watercourse then the regulations in Section 3.3.8 shall apply.

3.4.151.4 Other Regulations

For the purpose of this zone no further subdivision is permitted, including a bare land strata pursuant to the Bare Land Strata regulation, except a building strata pursuant to the *Strata Property Act*.

¹ Bylaw No. 500.404, adopted October 16, 2018

Section 3.4.152

LIGHTHOUSE VILLA COMPREHENSIVE DEVELOPMENT ZONE 52

CD52¹

3.4.152.1 Permitted Uses & Minimum Site Area

Permitted Principal Uses

- a) Seniors Housing
- b) Residential use

Permitted Accessory Uses

- a) Accessory Buildings and Structures

Permitted Accessory Uses to Seniors Housing

- 1. Medical Office
- 2. Personal Service Use
- 3. Public Assembly

3.4.152.2 Maximum Number and Size of Buildings and Structures

Seniors housing units	40
Dwelling units/parcel	2
Height	10.0 m
Parcel coverage	25%

3.4.152.3 Minimum Setback Requirements

For all buildings and structures unless otherwise set out in Part 3 Land Use Regulations:

Front lot line	8.0
Interior side lot line	5.0
Rear lot line	5.0
Exterior side lot line	5.0

Except where any part of a parcel is adjacent to or contains a watercourse then the regulations in Section 3.3.8 shall apply.

¹ Bylaw No. 500.418, adopted December 4, 2018

3.4.152.4 Off Street Parking Requirements

Seniors Housing	1 space per 2 employees and 1 space per 2 seniors housing units
Medical Office	1 space per 15 m ² of floor area

For all other uses permitted in this zone, parking shall be provided as set out under Schedule '3B' Off-Street Parking & Loading Spaces

3.4.152.4 Other Regulations

For the purpose of this zone:

- a) Accessory personal service and medical office uses, where provided, shall be contained within the seniors housing facility and shall be accessible from an internal hallway or corridor. The combined total floor area of all accessory personal service and medical office uses shall not exceed 150 m² per seniors housing facility.
- b) Personal service use shall be limited to barber shop or beauty salon.
- c) Public Assembly shall be limited to a church contained within the seniors housing facility and special events or meetings held within the common dining area or social room of the seniors housing facility.

3.4.152.5 Definitions

For the purpose of this zone:

- a) Seniors housing means a residential or institutional facility which provides for seniors housing units with common living facilities, and may provide support services such as one or more meals per day, a linen laundry service and may include a common dining area with a capacity sufficient to accommodate all residents of the facility.
- b) Seniors housing unit means a bedroom and associated living area within a seniors housing facility which is used or intended to be used for sleeping and living purposes and may or may not contain provisions for cooking.
- c) Medical Office means the office, clinic or laboratory of a licensed professional and may include a doctor, dentist, optometrist, physiotherapist, chiropractor and medical technician.

3.4.152.6 Condition of Use

- a) A Housing Agreement shall be required for Seniors Housing.
- b) Seniors Housing must be serviced by community water and community sewer.

REGIONAL DISTRICT OF NANAIMO

BYLAW NO. 500

SCHEDULE '3A'

ZONING MAPS

REGIONAL DISTRICT OF NANAIMO

BYLAW NO. 500

SCHEDULE '3B'

OFF-STREET PARKING & LOADING SPACES

1. GENERAL REQUIREMENTS

1.1 Location

All off-street parking and loading spaces shall be located:

- a) on the same parcel as the development, building or use they are intended to serve;
- b) subject to the setback requirements of the zone that applies to that parcel.

1.2 Disability Spaces

- 1) When any development, building or use requires or provides more than 20 off-street parking spaces, one parking space shall be provided for the use of persons with a physical disability, together with one additional disability space for each additional 50 off-street parking spaces required or provided.
- 2) Each disability space shall be:
 - a) a minimum of 4.0 m in width;
 - b) marked with the International Symbol of Accessibility for the Handicapped as specified in Table 3 of this Schedule; and
 - c) located within convenient access of the development, building or use that it is intended to serve, and with minimum changes in level.

1.3 Surface

When any development, building or use requires or provides more than 4 off-street parking spaces, all parking spaces and loading spaces shall be provided and maintained with a hard durable surface that does not produce dust.

1.4 Gradient

All parking and loading spaces shall have a maximum gradient and cross-slope of 6%.

2. OFF-STREET PARKING SPACES

2.1 Stall and Aisle Dimensions

All off-street parking spaces shall be in accordance with Table 2 of this Schedule.

2.2 Reduction in Stall Length for Small Cars

When any development, building or use provides more than 100 parking stalls, up to 20% of the total stalls may be reduced to 4.6 m in length provided those stalls are combined in groups of at least 20 stalls, and marked with the words "SMALL CAR ONLY" on the pavement or wall facing.

2.3 Access

Adequate provision shall be made for access by vehicles to all off-street parking spaces located in a parking area by means of unobstructed maneuvering aisles, the dimensions of which shall be in conformity with Table 2 of this Schedule.

2.4 Vertical Clearance

The minimum vertical clearance of parking stalls and aisles shall be 2.25 m.

2.5 Calculation

- 1) The minimum number of off-street parking spaces shall be provided in accordance with Table 1 of this Schedule.
- 2) If a use is not listed in Table 1, the number of spaces shall be calculated on the basis of a similar use that is listed.
- 3) If more than one use is located on a parcel or parking collectively serves more than one building or use, the total number of spaces shall be the sum of the various classes of uses calculated separately, and the parking or loading space required for one use shall not be included in calculations for any other use.
- 4) Where the calculation of a total required space results in a fractional number, the nearest whole number above that calculation shall be taken.
- 5) The required number of off-street parking spaces need not be provided where an addition or alteration to a building or a change in its use would result in an increase of less than 10% of the number of spaces required up to a maximum of 5 spaces; where an addition, alteration or change in use requires more than 5 spaces the number of spaces determined by Table 1 shall be provided.

3. LOADING SPACES

3.1 Dimensions

All off-street loading spaces shall be a minimum of 9.0 m in length and 3.0 m in width, and have a vertical clearance of 4.0 m.

3.2 Access

Adequate provision shall be made for access by vehicles to all off-street loading spaces by means of a 6.0 m maneuvering aisle and shall be located so that each separate use within a development has access to a space.

3.3 Demarcation

All off-street loading spaces shall be clearly marked with the words "LOADING SPACE ONLY" on the pavement or wall facing.

3.4 Calculation

For commercial, industrial or public use 1 off-street loading space shall be provided for every 2000 m² of floor area or portion thereof of all buildings located on a parcel, except where a use requires less than 4 parking spaces then no loading space shall be required.

REGIONAL DISTRICT OF NANAIMO

BYLAW NO. 500

SCHEDULE '3B'

TABLE 1

REQUIRED NUMBER OF OFF STREET PARKING SPACES

The minimum number of off-street parking spaces shall be provided in accordance with the following table:

Use	Required Parking Spaces
Residential	
Mobile Home Parks	(see Schedule '3D' of this Bylaw)
Multi-unit dwellings	1 per 4 units (visitor) plus
- bachelor	1 per dwelling unit
- 1 bedroom	1.25 per dwelling unit
- 2 bedrooms	1.50 per dwelling unit
- 3 or more bedrooms	2 per dwelling unit
Single dwelling unit and duplex	2 per dwelling unit
Home based business, excluding bed and breakfast	2 plus 1 per non-resident employee
Bed and breakfast	1 per bedroom used for bed and breakfast
Commercial	
Agri-tourism Accommodation Cabin ¹	one per cabin
Animal Care	1 per 20.0 m ² of floor area
Automotive Repair ²	1 per 70.0 m ² gross floor area plus 1 per service bay
Bowling Alley	3 per lane
Campground	(see Schedule '3C' of this Bylaw)
Fairground	1 per 2 employees plus 1 per 100 m ² of site area
Fast Food Outlet	1 per 10.0 m ² of floor area
Farm Retail Sales ³⁺	one per 5 m ² of floor area plus one per two Employees
Financial Institution	1 per 20.0 m ² of floor area
Funeral Parlour	1 per 4 seats in Chapel
Gasoline Service Station	4 per service bay plus 1 per 15.0 m ² of floor area
Gathering for Events	1 spot per 4 guests must be available on the farm, but must not be permanent nor interfere with the farm's agricultural productivity and must be setback 15.0 m from all lot lines. ⁴
Golf Course (9 holes)	75 spaces per 9 holes

¹ Bylaw 500.383, adopted June 25, 2013

² Bylaw 500.408, adopted August 22, 2017

³ Bylaw 500.383, adopted June 25, 2013

⁴ Bylaw No. 500.413, adopted May 22, 2018

Golf Driving Range	2 per tee
Health Club, Spa, Games Court, Gymnasium	1 per 10.0 m ² of fitness or gymnasium floor area
Heavy Equipment Display	1 per 70.0 m ² of floor area
Hotel or Resort Condominium	1 per unit, plus 1 per 3 seats in restaurant or licensed premises, plus 1 per 4 units (visitor)
Laundromat	1 per 3 washing machines
Laundry and Dry Cleaning Establishment	1 per 2 employees counted as a total of 2 shifts
Marina	1 per 2 mooring berths plus 1 per 2 employees
Neighbourhood Pub	1 per 3 seats
Nursery	1 per 15.0 m ² of sales building
Office	1 per 15.0 m ² of floor area
- medical	
- single tenant	1 per 32.0 m ² of floor area
- multi tenant	1 per 30.0 m ² of floor area
Personal Service	1 per 50.0 m ² of floor area
Produce Market or Stand	1 per 5.0 m ² of floor area plus 1 per 2 employees
Restaurant	1 per 10.0 m ² of floor area
Retail, Tourist or Convenience Store	1 per 15.0 m ² of floor area
Shopping Centre- to 5000 m ² g.l.a.	6.5 per 100 m ² g.l.a.
- to 15 000 m ² g.l.a.	5.5 per 100 m ² g.l.a.
- above 15 000 m ² g.l.a.	1.5 per 100 m ² g.l.a.
Ski Resort	0.5 per person hourly capacity of ski lift
Theatre, Drive-in	1 per 2 employees
Industrial	
Medium Industry	1 per 50.0 m ² of floor area
Taxi Stand	1 per taxi plus 1 per office employee
Transportation Terminal (excluding Taxi Stand)	1 per 10.0 m ² of waiting room
All other Industrial Uses	1 per 175.0 m ² of floor area used for storage 1 per 95.0 m ² of floor area used for display 1 per 15.0 m ² of floor area used for sales
Public and Institutional Uses	
Beach, Swimming	1 per 9.0 m ² developed beach above high water mark
Cabin	2 per cabin
Church	1 per 4 seats
Church Hall, Lodge Hall, Private Clubs, Community Hall	1 per 20.0 m ² of floor area
College	10 per classroom
Day Care Facility	2 per facility plus 1 per employee
Hospital	1 per 2 employees plus 1 per 5 beds
Personal Care	1 per 3 beds
Police Office, Fire Station, Prison	1 per 2 employees counted as a total of 2 shifts
Recreational or Cultural Facility	1 per 50.0 m ² of floor area or 1 per 3 spectator seats or 1 per 5.0 m ² of floor area used for dancing or assembly or 1 per 4 persons capacity, whichever is the greater

Swimming Pool	1 per 5.0 m ² of pool water surface
Public Utility	1 per employee
School - Elementary	2 per classroom
- Secondary	5 per classroom
Tourist Information Booth	4 per employee

REGIONAL DISTRICT OF NANAIMO

BYLAW NO. 500

SCHEDULE '3B'

TABLE 2

PARKING STALL AND AISLE DIMENSIONS

The minimum parking stall and aisle dimensions shall be in accordance with the following:

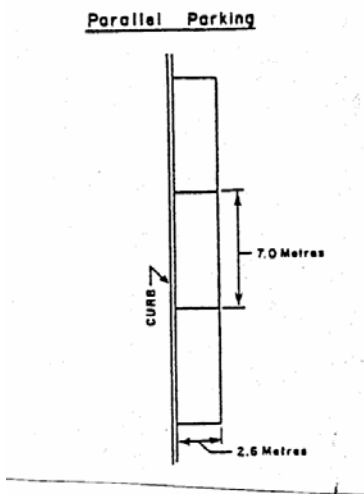
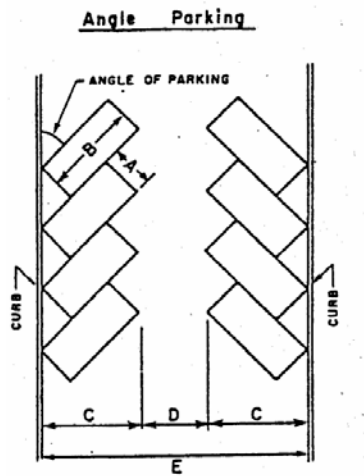

Angle	Stall Width (A)	Stall Length (B)	Stall Depth to Curb (C)	Aisle Width (D)	Module (E)
10 degrees	2.5 m	5.2 m	2.5 m	3.7 m	8.7 m
	2.6	5.2	2.6	3.7	8.9
	2.7	5.2	2.7	3.7	9.1
	2.8	5.2	2.8	3.7	9.3
	2.9	5.2	2.9	3.7	9.5
	3.0	5.2	3.0	3.7	9.7
20 degrees	2.5 m	5.2 m	4.3 m	3.4 m	12.1 m
	2.6	5.2	4.4	3.4	12.3
	2.7	5.2	4.5	3.4	12.4
	2.8	5.2	4.6	3.4	12.6
	2.9	5.2	4.7	3.4	12.8
	3.0	5.2	4.8	3.4	13.0
30 degrees	2.5 m	5.2 m	5.1 m	3.4 m	13.5 m
	2.6	5.2	5.2	3.4	13.7
	2.7	5.2	5.2	3.4	13.9
	2.8	5.2	5.3	3.4	14.0
	2.9	5.2	5.4	3.4	14.2
	3.0	5.2	5.5	3.4	14.4
40 degrees	2.5 m	5.2 m	5.6 m	3.9 m	15.2 m
	2.6	5.2	5.7	3.7	15.1
	2.7	5.2	5.8	3.7	15.3
	2.8	5.2	5.9	3.7	15.4
	2.9	5.2	5.9	3.7	15.6
	3.0	5.2	6.0	3.7	15.8
45 degrees	2.5 m	5.2 m	5.9 m	4.3 m	16.0 m
	2.6	5.2	5.9	4.1	16.0
	2.7	5.2	6.0	3.9	15.9
	2.8	5.2	6.1	3.9	16.1
	2.9	5.2	6.2	3.9	16.2
	3.0	5.2	6.2	3.9	16.3
50 degrees	2.5 m	5.2 m	6.1 m	4.3 m	16.4 m
	2.6	5.2	6.1	3.8	16.0
	2.7	5.2	6.2	3.7	16.1
	2.8	5.2	6.2	3.7	16.2
	2.9	5.2	6.3	3.7	16.3
	3.0	5.2	6.4	3.7	16.4
60 degrees	2.5 m	5.2 m	6.3 m	5.8 m	18.3 m
	2.6	5.2	6.3	5.6	18.2
	2.7	5.2	6.4	5.5	18.2
	2.8	5.2	6.4	5.5	18.3
	2.9	5.2	6.5	5.5	18.4
	3.0	5.2	6.5	5.5	18.5
70 degrees	2.5 m	5.2 m	6.3 m	5.8 m	18.3 m
	2.6	5.2	6.3	5.6	18.2

Aisle	Stall Width (A)	Stall Length (B)	Stall Depth to Curb (C)	Aisle Width (D)	Module (E)
	2.7	5.2	6.4	5.5	18.2
	2.8	5.2	6.4	5.5	18.3
	2.9	5.2	6.4	5.5	18.4
	3.0	5.2	6.5	5.5	18.5
80 degrees	2.5 m	5.2 m	6.1 m	7.6 m	19.9 m
	2.6	5.2	6.2	7.3	19.6
	2.7	5.2	6.2	7.3	19.7
	2.8	5.2	6.2	7.3	19.7
	2.9	5.2	6.2	7.3	19.7
	3.0	5.2	6.2	7.3	19.8
90 degrees	2.5 m	5.2 m	5.8 m	7.9 m	19.5 m
	2.6	5.2	5.8	7.6	19.2
	2.7	5.2	5.8	7.3	18.9
	2.8	5.2	5.8	7.3	18.9
	2.9	5.2	5.8	7.3	18.9
	3.0	5.2	5.8	7.3	18.9

REGIONAL DISTRICT OF NANAIMO

BYLAW NO. 500

SCHEDULE '3B'

TABLE 3

DISABILITY SPACE DESIGNATION

Minimum Size

- | | | |
|---------------------|---|------------------------------------|
| Wall facing or sign | - | 0.3 m in width and 0.3 m in height |
| Pavement marking | - | 1.0 m in width |



**International Symbol of Accessibility
for the Handicapped**

REGIONAL DISTRICT OF NANAIMO

BYLAW NO. 500

SCHEDULE '3C'

CAMPGROUND REGULATIONS AND STANDARDS

REGIONAL DISTRICT OF NANAIMO

BYLAW NO. 500

SCHEDULE '3C'

CAMPGROUND REGULATIONS AND STANDARDS

Campgrounds shall be established or extended in accordance with the following regulations and standards:

1. LAYOUT STANDARDS

1.1 *Camping Spaces*

- 1) Every camping space shall have a minimum area of not less than 110 m².
- 2) Every camping space shall have a maximum slope of 5%.
- 3) No camping space shall be located within:
 - a) 3.0 m of an internal access road; and
 - b) the setback areas in the applicable zones established pursuant to Part 3.4 of this Bylaw.
- 4) Each camping space shall have one conveniently located parking space adjacent to the internal access road and may be sited in the area allotted for the 3.0 m setback.
- 5) No recreation vehicle or tent shall be located elsewhere in a campground than on a camping space.
- 6) Only one recreational vehicle or tent shall be located on a camping space.

1.2 *Buffer Area*

- 1) Within a setback area established pursuant to Part 3.4 of this Bylaw the following shall not be located:
 - a) recreational or service area, except for waterfront recreation or amenity areas;
 - b) a camping space or the residence of the owner or manager;
 - c) any building or structure, except a fence, a wall or a campground identification sign not exceeding 1.5 m² in area;
 - d) a sewage disposal system, other than such parts of such a system as may be underground;
 - e) vehicle parking; or
 - f) internal access roads except those that directly traverse the setback area to connect the internal access road system of the campground to a highway.

1.3 *Internal Access Roads*

- 1) All internal access roads in the campground shall be of hard durable surface so as not to produce dust.
- 2) The minimum internal access road width requirement shall be 6.0 m.

- 3) Dead-end internal access roads and cul-de-sacs shall have a turning circle radius of 12.0 m.
- 4) The maximum grade of any internal access road shall be 10%.

1.4 Parking

Every campground shall provide for:

- a) one parking space for each employee; and
- b) three parking spaces for the owner's or manager's residence.

2. SERVICING

2.1 Sewage Disposal

Sewage disposal shall be by a community sewer system or a septic disposal system constructed to the standards of the relevant enactments.

2.2 Washroom Facilities

Washroom facilities shall be provided in every campground, and:

- a) shall be located in a separate building or buildings;
- b) shall be located a maximum of 150 m from any camping space and a minimum of 4.5 m from any camping space;
- c) the quantity of toilets, urinals, wash basins and showers shall be provided in accordance with the following table:

**TABLE 1
WASHROOM FACILITIES**

No. of Camping Spaces	Toilets		Urinals	Washbasins		Showers	
1-15	1	1	1	1	1	1	1
16-30	1	2	1	2	2	1	1
31-45	2	2	1	3	3	1	1
46-60	2	3	2	3	3	2	2
61-80	3	4	2	4	4	2	2
81-100	3	4	2	4	4	3	3
101-130	4	5	3	5	5	4	4
131-150	5	6	3	5	5	5	5

2.3 Sewage Disposal Station

One sewage disposal station for use by recreational vehicles shall:

- a) be established in every campground that contains more than 60 camping spaces; and
- b) be located in an area apart from any internal access road and to allow easy and convenient access by recreational vehicles for the purpose of disposing of the contents of such vehicle's sewage storage tanks; and

- c) be constructed in accordance with Table '2A' and '2B' of this Schedule.

2.4 Water System

- 1) All camping spaces shall be a maximum of 60.0 m from a standpipe, constructed in accordance with Table '3A' of this Schedule.
- 2) Every campground that contains more than 60 camping spaces shall be serviced by a community water system or a water supply system built to the standards of the Regional District of Nanaimo, as specified in Schedule '4D' of this Bylaw, and:
 - a) a minimum of 0.18 m³ per day of potable water per camping space shall be provided;
 - b) 20% of all camping spaces in the campground shall be equipped with a water hook-up for recreational vehicles.

2.5 Laundry Facilities

Laundry facilities shall be:

- a) provided in every campground that contains more than 60 camping spaces;
- b) provided in the ratio of 1 clothes washing machine and 1 clothes dryer for every 30 camping spaces or portion thereof;
- c) located in a separate room of a sanitary facility or building or in a separate building.

2.6 Garbage Disposal

- 1) For the disposal of garbage a minimum of one container shall be provided for every 2 camping spaces.
- 2) Each container shall be durable, insect-tight, water-tight and rodent-proof and shall be constructed in general compliance with standards set out in Tables '4A' or '4B' of this Schedule.

REGIONAL DISTRICT OF NANAIMO

BYLAW NO. 500

SCHEDULE '3C'

TABLE 2A

TRAILER SEWAGE DISPOSAL SYSTEM

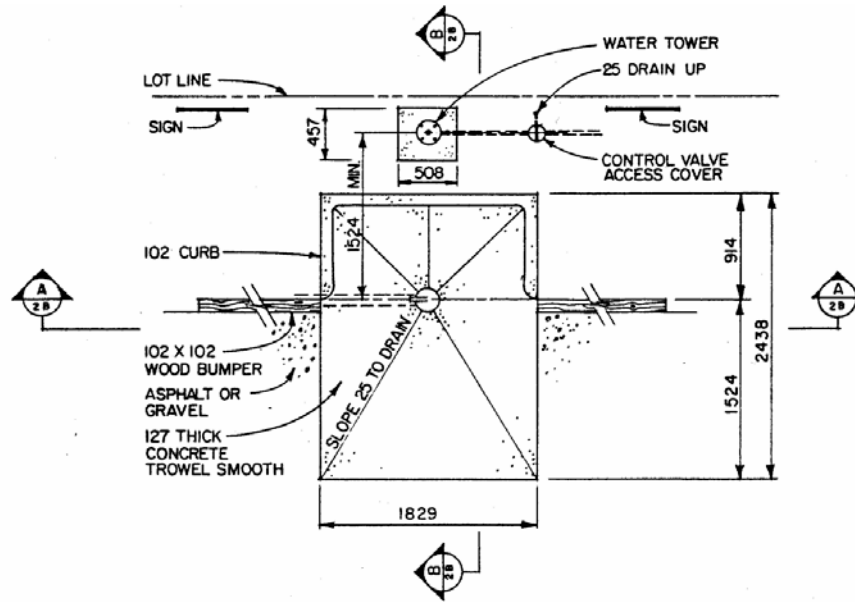

PLAN
(All Dimensions in Millimetres)

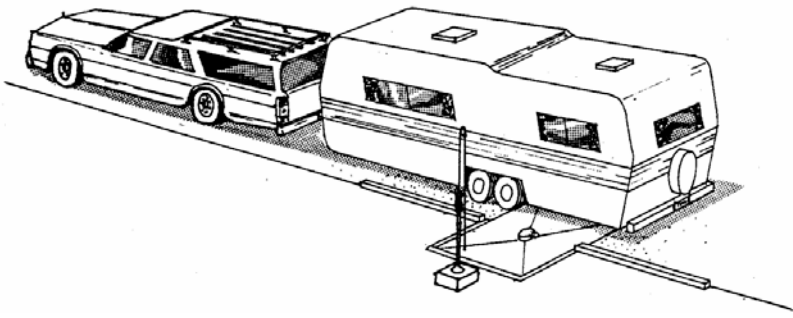

REGIONAL DISTRICT OF NANAIMO

BYLAW NO. 500

SCHEDULE '3C'

TABLE 2B

TRAILER SEWAGE DISPOSAL SYSTEM

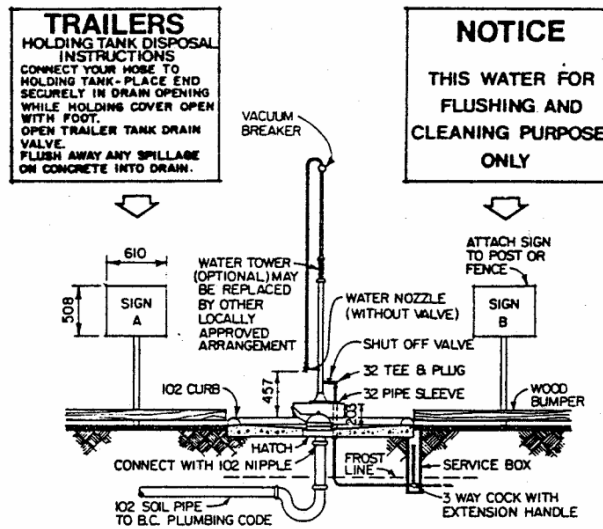

CROSS-SECTION A-A
(All Dimensions in Millimetres)

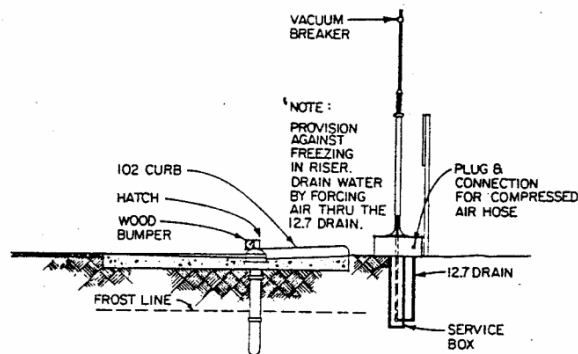

CROSS-SECTION B-B
(All Dimensions in Millimetres)

REGIONAL DISTRICT OF NANAIMO

BYLAW NO. 500

SCHEDULE '3C'

TABLE 3A

WATER STANDPIPE TAP

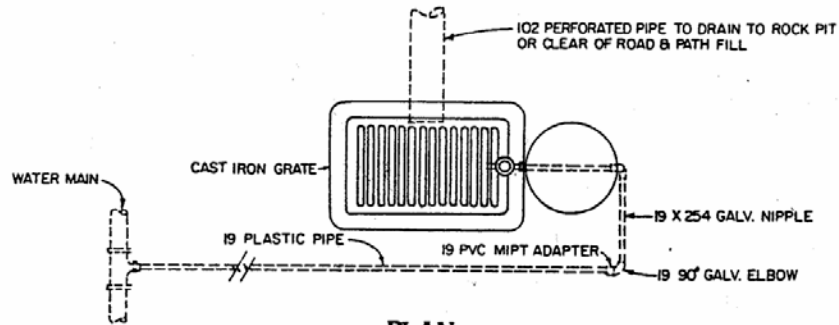

PLAN
(All Dimensions in Millimeters)

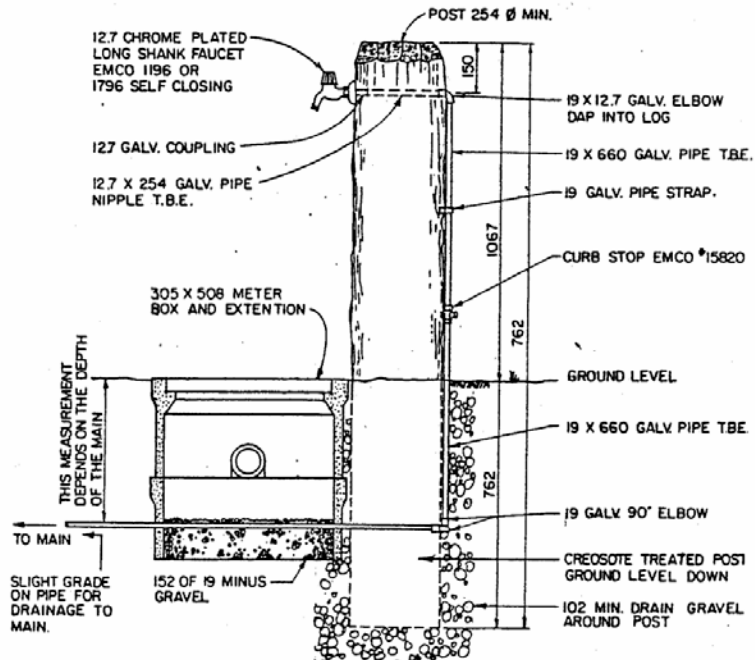

ELEVATION
(All Dimensions in Millimetres)

REGIONAL DISTRICT OF NANAIMO

BYLAW NO. 500

SCHEDULE '3C'

TABLE 4A

GARBAGE CAN HOLDER

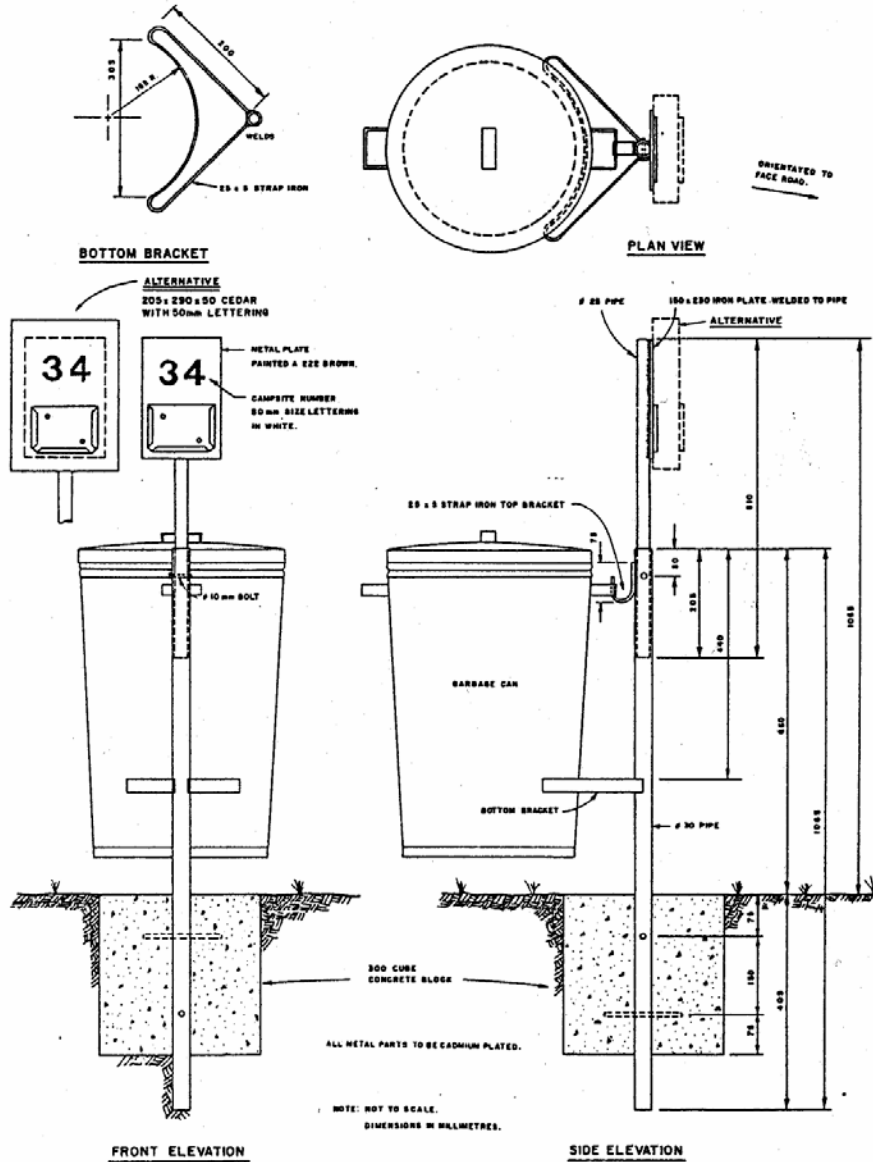

REGIONAL DISTRICT OF NANAIMO

BYLAW NO. 500

SCHEDULE '3C'

TABLE 4B

SUSPENDED GARBAGE CONTAINER

(170 l Oil Barrel)

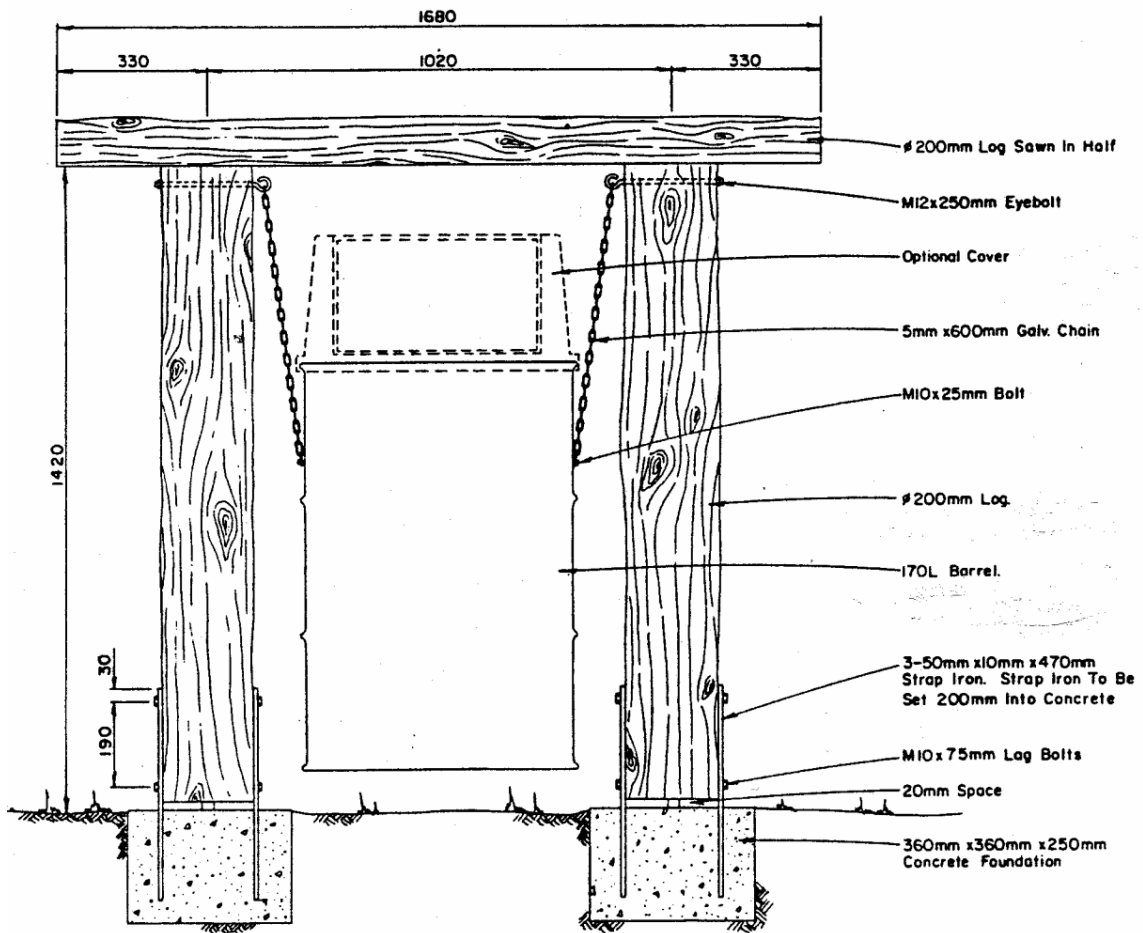

ELEVATION

REGIONAL DISTRICT OF NANAIMO

BYLAW NO. 500

SCHEDULE '3D'

**RESIDENTIAL MOBILE HOME PARK
REGULATIONS AND STANDARDS**

REGIONAL DISTRICT OF NANAIMO

BYLAW NO. 500

SCHEDULE '3D'

RESIDENTIAL MOBILE HOME PARK REGULATIONS AND STANDARDS

Mobile home parks shall be established or extended in accordance with the following regulations and standards:

1. GENERAL REQUIREMENTS

- 1) No person shall establish, construct, alter or subdivide a mobile home park until written approval of detailed plans or specifications is received and a Mobile Home Park Permit is issued by the Regional District.
- 2) Nothing contained in this Schedule shall relieve any person from obtaining the necessary building permits and approvals for buildings and structures constructed, located or relocated in a mobile home park.
- 3) A copy of the Mobile Home Park Permit, a copy of this Schedule, and Part 3.4.66 of this Bylaw shall be permanently posted in the mobile home park office for the reference of mobile home park occupiers.

2. MOBILE HOME PARK APPLICATION, FEE, APPROVAL AND PERMIT

2.1 Application

All applications for approval of plans and specifications shall be made in writing to the Regional District and shall include 2 full sets of working drawings to scale showing:

- a) the name and address of the applicant;
- b) the legal description of the land on which the proposed mobile home park is to be established, constructed, altered or extended;
- c) a north arrow and notations of scales used;
- d) the parcel dimensions;
- e) the location and dimensions of the setback area;
- f) the number, location, dimensions and designation of all mobile home spaces;
- g) the location, dimensions and grade of all internal access roads and their relationship to existing highways;
- h) the location and dimensions of all recreation or common areas;
- i) the location and dimensions of the owner's or manager's dwelling unit and all other accessory buildings;
- j) the location and details of the source of potable water supply, treatment plants, distribution lines and outlets;
- k) the location and details of all connections to the sewer, sewer lines, septic tank and subsurface disposal fields;
- l) the location and details of all on-site refuse disposal areas;
- m) a landscaping plan for the mobile home park;
- n) all watercourses or water frontage within or adjacent to the mobile home park;
- o) all steep banks or slopes within or adjacent to the land concerned; and
- p) any other information the Regional District may deem necessary.

2.2 Permit Application Fee

Each application for a Mobile Home Park Permit shall be accompanied by an application fee of \$25.00 for the first mobile home space and \$10.00 for each additional mobile home space shown on the mobile home park plan.

2.3 Approval of Application and Permit

- 1) No person shall establish, construct or alter a mobile home park without a Mobile Home Park Permit issued by the Regional District.
- 2) A Mobile Home Park Permit shall permit the establishment of a mobile home park on the land concerned only in compliance with the mobile home park plan as approved and for which a permit has been issued.
- 3) A Mobile Home Park Permit shall not be issued until the necessary permits and approvals have been granted by the other authorities also having jurisdiction.
- 4) Subsequent to examination of an application the Regional District shall notify the applicant in writing within 60 days that either a Mobile Home park Permit is issued or that it is refused and the reasons therefore.
- 5) In the event that after the issuance of a Mobile Home Park Permit, the construction authorized thereunder is not commenced within 180 days from the date of issuance, then such permit shall be void, and the work shall not be commenced until a new permit has been issued and the fee paid.

3. STANDARDS

3.1 Mobile Home Spaces

- 1) Every mobile home space shall:
 - a) have a minimum area of 370 m²;
 - b) have a maximum of 6% longitudinal and 15% cross or crown gradient;
 - c) have 1 conveniently located parking space in the mobile home space area, and such parking space shall have a minimum width of 3.0 m and a minimum length of 6.0 m;
 - d) be properly drained;
 - e) be clearly numbered; and
 - f) have a clearly discernible mobile home pad.
- 2) No mobile home shall be located elsewhere in a mobile home park than on a mobile home space, and not more than 1 mobile home shall be located on a mobile home space.

3.2 Mobile Home Standards

- 1) Every mobile home located on a mobile home space shall be supported by a double blocking system of blocking in which blocks of alternate courses are placed at 90 degrees.
- 2) In a mobile home:
 - a) the installation of all woodstoves and chimneys;
 - b) the installation and maintenance of all oil burners and oil-burning equipment and appliances using inflammable liquids as fuel;
 - c) the storage and disposal of inflammable liquids and oils;
 - d) the installation, maintenance, carriage and use of compressed gas systems;
 - e) the plumbing and electrical installation; and
 - f) the connections to services; shall be in accordance with the regulations of the authority having jurisdiction.

- 3) Skirtings shall be installed within 60 days of installation of a mobile home on a mobile home pad.

3.3 Accessory Building and Structures

- 1) One storage shed or utility building may be constructed on each mobile home space provided that the building has:
 - a) a maximum height of 2.5 m;
 - b) a maximum floor area of 9.0 m².
- 2) Common accessory buildings and structures shall be limited to buildings and structures generally intended for the common use of mobile home park occupiers and includes facilities for storage, laundry, service and recreation.

3.4 Owner's or Manager's Dwelling Unit

The space allotted for the owner's or manager's dwelling unit shall be developed in the same manner as a mobile home space where applicable, except where the residence is not a mobile home, then the minimum space allotted shall be 500 m².

3.5 Siting

No part of any mobile home or any addition shall be located within:

- a) 6.0 m of another mobile home or addition thereto;
- b) 2.0 m of an internal access road or common parking area;
- c) 1.5 m of rear and side mobile home space lines;
- d) 6.5 m of any common accessory building.

3.6 Access

- 1) No mobile home park shall be established or extended unless the highway access to the mobile home park is approved by the authority having jurisdiction.
- 2) A second access from a highway separated by at least 60.0 m from the first access shall be provided for each mobile home park containing 50 or more mobile home spaces.
- 3) Access to all parts of a mobile home park shall be by way of the internal access roads and no part of a mobile home park shall have direct access from a highway.

3.7 Layout

The minimum frontage of each mobile home space on the internal access road shall be 12.0 m, except in the case of a mobile home space abutting a cul-de-sac the minimum frontage shall be 6.0 m.

3.8 Internal Access Roads

- 1) All internal access roads within a mobile home park shall be:
 - a) of a hard durable surface so as not to produce dust;
 - b) well drained;
 - c) maintained;
 - d) adapted to the topography.
- 2) The maximum grade of all internal access roads shall be 7%.
- 3) The minimum internal access road width requirements shall be as follows:
 - a) access roads from a mobile home park to a highway shall have a minimum surfaced width of 6.5 m and a right of way width of 15.0 m, and no parking shall be allowed on such internal access roads.

- b) all other internal access roads:
 - i) with parking on both sides shall have a minimum surfaced width of 11.0 m and a right of way of 14.0 m;
 - ii) with parking on one side shall have a minimum surfaced width of 8.5 m and a right of way of 12.0 m;
 - iii) with no parking shall have a minimum surfaced width of 5.0 m and a right of way of 12.0 m.
- 4) Cul-de-sacs shall not exceed 100 m in length.
- 5) Dead-end internal access roads and cul-de-sacs shall have a turning circle right of way at the dead end with a radius of at least 12.0 m.

3.9 Parking

For every 2 mobile home spaces, 1 additional parking space shall be provided, and shall:

- a) be located in the internal access road or in grouped parking areas of no larger than 20 parking spaces;
- b) have a minimum width of 3.0 m and a minimum length of 6.0 m;
- c) be provided and maintained with a hard durable surface that does not produce dust;
- d) be property drained.

3.10 Buffer Area

- 1) To provide a buffer area, no mobile home space shall be located within the setback areas provided in Part 3.4 of this Bylaw.
- 2) Within a setback required pursuant to Part 3.4 of this Bylaw the following shall not be located:
 - a) recreational or service areas, except for waterfront recreation or amenity areas;
 - b) mobile home spaces or the owner's or manager's residence;
 - c) any building or structure, except a fence, a wall or mobile home park identification sign not exceeding 1.5 m² in area;
 - d) a sewage disposal system;
 - e) vehicle parking;
 - f) internal access roads, except those that directly connect the road system of the mobile home park to a highway.

3.11 Recreation Area

- 1) Not less than 5% of the gross site area of the mobile home park shall be devoted to tenant's recreational uses, and shall be provided in a convenient and accessible location; and for the purpose of calculating recreational space requirements, any indoor recreational space provided shall be counted as double its actual floor area.
- 2) The recreation areas shall not include setback areas, parking areas, common accessory buildings, internal access roads and mobile home spaces.
- 3) In mobile home parks where more than 1000 m² of recreation space is required, 2 or more recreation areas may be provided.
- 4) Recreation areas in the mobile home park, except indoor recreation facilities, shall be of grass or asphaltic surface and shall be property landscaped.

3.12 Refuse Disposal

- 1) No person residing in a mobile home park shall dispose of refuse or any sort of waste except in accordance with the arrangements made by the owner or manager of the mobile home park, and approved by the authority having jurisdiction.

- 2) The owner or manager of a mobile home park may establish 1 or more containers within the park for the collection of refuse. Such containers shall be durable, insect-tight, water-tight and rodent-proof.

3.13 Water System

- 1) Pursuant to Part 3.4 of this Bylaw, in the event that the number of mobile homes per mobile home park does not require the provision of a community water system, then every mobile home park shall have a water supply system built to the standards of the Regional District of Nanaimo, as specified in Schedule '4C' of this Bylaw.
- 2) The water supply system shall furnish a constant supply of potable water that is under a minimum working pressure of 200 kPa and not over a maximum working pressure of 350 kPa at all outlets.
- 3) The water supply system shall distribute water to each:
 - a) accessory building, if required;
 - b) mobile home space by a distribution branch line with a minimum diameter of 18 mm;
 - c) hydrant;
 - d) hose bib.

3.14 Sewage Disposal

Pursuant to Part 3.4 of this Bylaw, in the event that the number of mobile homes per mobile home park does not require the provision of a community sewer system, then every mobile home park shall be served by a septic disposal system constructed to the standards of the authority having jurisdiction.

3.15 Fire Hydrants

Fire hydrants meeting the requirements of the Regional District as specified in Schedule '4C' of this Bylaw shall be installed and connected to the internal water supply of a mobile home park so that no mobile home space is beyond 120 m from a fire hydrant, as measured along the internal access road.

3.16 Streetlighting

Streetlighting shall be installed and maintained to adequately illuminate the traveled portion of the internal access roads at the following locations:

- a) the intersection of internal access roads and a highway;
- b) all internal intersections;
- c) the turning circle of cul-de-sacs;
- d) any point at which an internal access road changes direction 30 degrees or more.

REGIONAL DISTRICT OF NANAIMO

BYLAW NO. 500

SCHEDULE '3E'

SETBACKS FROM WATERCOURSES

REGIONAL DISTRICT OF NANAIMO

BYLAW NO. 500

SCHEDULE '3E'

TABLE 1

SETBACKS FROM WATERCOURSES

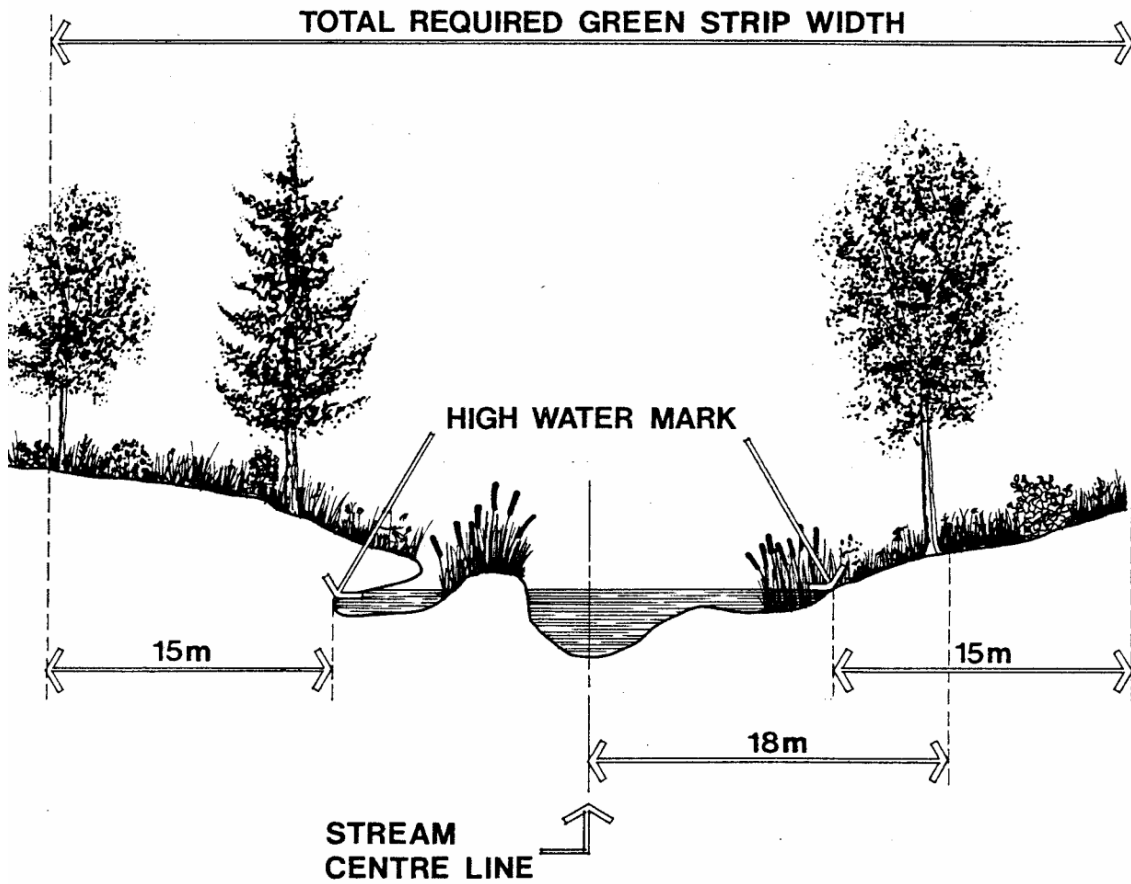

REGIONAL DISTRICT OF NANAIMO

BYLAW NO. 500

SCHEDULE '3E'

TABLE 2

SETBACKS FROM WATERCOURSES

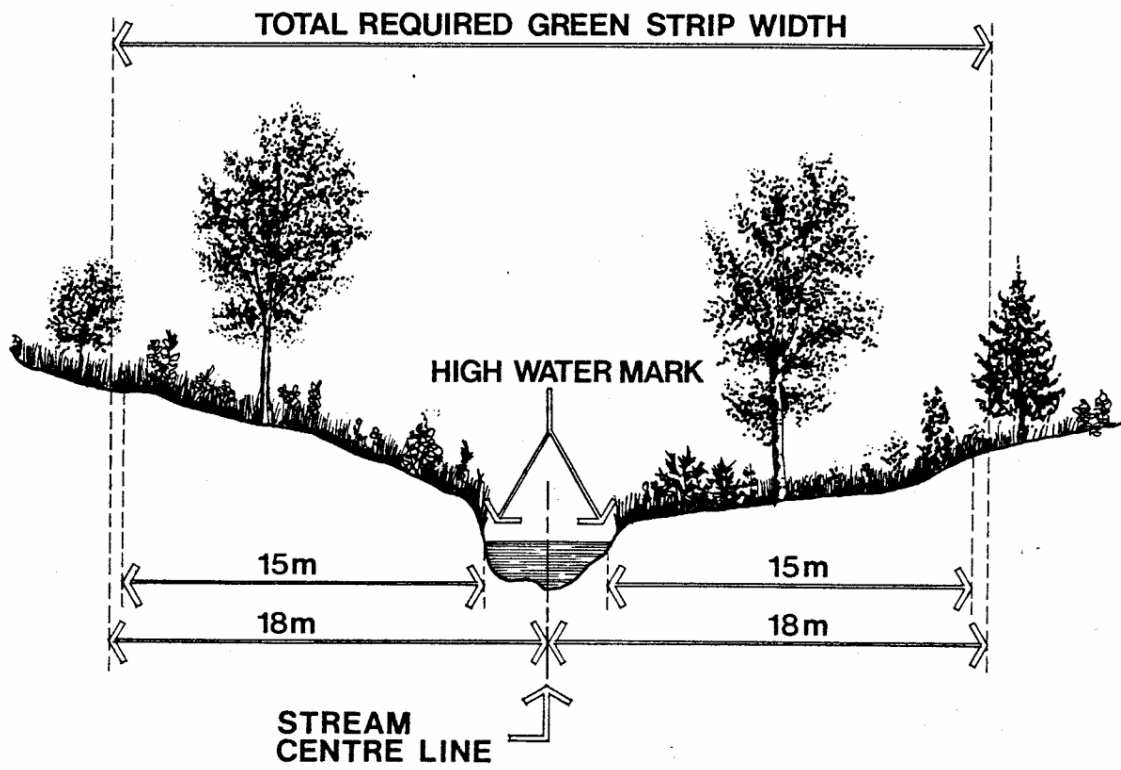

REGIONAL DISTRICT OF NANAIMO

BYLAW NO. 500

SCHEDULE '3E'

TABLE 3

SETBACKS FROM WATERCOURSES

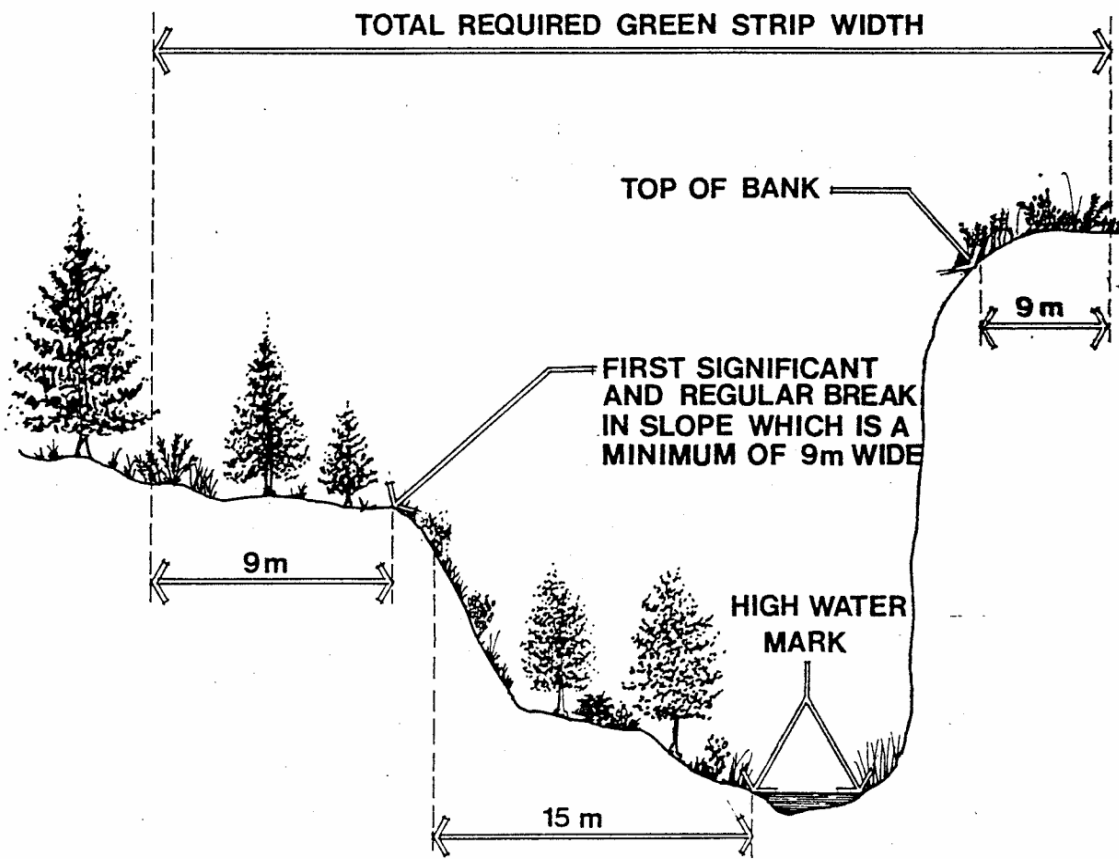

REGIONAL DISTRICT OF NANAIMO

BYLAW NO. 500

SCHEDULE '3F'

LANDSCAPING REGULATIONS AND STANDARDS

REGIONAL DISTRICT OF NANAIMO
BYLAW NO. 500
SCHEDULE '3F'
LANDSCAPING REGULATIONS AND STANDARDS
TABLE OF CONTENTS

PART 1 - INTERPRETATION.....	3F-3
1.1 Definitions	3F-3
PART 2 - GENERAL.....	3F-4
2.1 Requirement.....	3F-4
2.2 Procedure	3F-5
2.3 Drawings and Specifications.....	3F-5
2.4 Variations from Standards.....	3F-5
2.5 Applicability ⁵	3F-5
PART 3 - DESIGN.....	3F-5
3.1 Design Standards - Landscape Screen	3F-6
3.2 Design Standards - Landscape Buffer	3F-6
3.3 Selection of Introduced Vegetation	3F-6
3.4 Planted Berms	3F-6
PART 4 - CONSTRUCTION.....	3F-7
4.1 Timing	3F-7
4.2 General	3F-7
PART 5 - SECURITY DEPOSIT.....	3F-7
5.1 Requirement.....	3F-7
5.2 Type and Value of Security Deposit.....	3F-7
5.3 Release of Security Deposit.....	3F-8

⁵ Bylaw No. 500.360, adopted January 25, 2011

REGIONAL DISTRICT OF NANAIMO

BYLAW NO. 500

SCHEDULE '3F'

LANDSCAPING REGULATIONS AND STANDARDS

PART 1 - INTERPRETATION

1.1 Definitions

In this Schedule unless the context otherwise requires:

designated highway means a road listed in Appendix 1 of this Schedule;

fence means a barrier under 2.0 m in height assembled of wooden planks or panels, rock, concrete or brick or any combination thereof;

introduced vegetation means vegetation planted on a parcel to provide a landscape buffer and includes ground covers, vines, shrubs and trees, but specifically excludes weed species;

landscape buffer means an area of preserved natural vegetation, introduced vegetation or a planted berm or any combination thereof;

landscape plan means drawings and specifications, as required by this Schedule, showing proposed landscape buffer or landscape screen;

landscape screen means an area of trees, fences, evergreen vegetation or planted berm or any combination thereof, intended to block or mask from view certain uses as specified in this Schedule;

landscaping means the design, construction and maintenance of a landscape buffer, landscape screen, fencing, land contouring or drainage works;

natural vegetation means vegetation existing on site prior to clearing or cutting and includes vegetation native to Southwestern British Columbia, but specifically excludes weed species;

planted berm means a mound of earth the surface of which is covered by introduced vegetation.

site improvements means the design, construction or maintenance of physical alterations or improvements to land intended to address the safety and functionality of development, including, but not limited to, parking, access or removal of existing structures or buildings.

PART 2 - GENERAL

2.1 Requirement

- 1) A landscape buffer shall be provided within the setback area of a parcel adjacent to a designated highway to provide vegetative landscape separation between industrial, commercial and multiple dwelling unit development uses of the parcel from a designated highway.
- 2) A landscape screen shall be provided within the setback area of a parcel adjacent to a designated highway to mask outdoor storage and outdoor industrial activity of a parcel where storage or industrial activity is taking place in conjunction with an industrial, commercial or multiple dwelling unit use of the parcel.
- 3) Where an owner proposes to use a parcel of land in circumstances or in a manner that requires a landscape buffer or landscape screen pursuant to Section 2.1.1 or Section 2.1.2 of this bylaw, the owner shall submit a landscape plan to the Regional District at the time of:
 - a) application for a building permit;
 - b) actual commencement of the use;
 - c) application for a development permit;
 - d) with respect to those parts of the Regional District not subject to the provisions of "Regional District of Nanaimo Building Regulations and Fees Bylaw No. 800, 1989" at the time of an application to rezone the property.
- 4) All landscaping shall be permanently maintained in good condition with the same quality and quantity of landscaping as was initially approved and without alteration of the approved design; the owner shall make provision for permanent irrigation works necessary to water the landscaping.
- 5) The design of landscaping shall be such that the growth of roots, trunks and branches of natural or introduced vegetation or the location of planted berms shall not conflict with utilities, structures, necessary access or a required sight triangle.

2.2 Procedure

In satisfying the requirements of this Schedule, the applicant shall complete three steps as follows:

1) Landscape Plan

Drawings and specifications of the proposed landscaping, which shall include a schedule of construction and date of completion, shall be submitted in duplicate to the Regional District for approval before any landscape works or building construction are started.

2) Landscape Works

The applicant shall complete the proposed work in accordance with the plans and specifications approved by the Regional District.

The Regional District will inspect the landscaping from time to time for conformity to these standards. There will be no charge for such inspections. The applicant shall be responsible for construction layouts, detailed field supervision of the work and as-constructed drawings.

3) Completion and Acceptance

Once the work is completed two sets of as-constructed drawings shall be submitted to the Regional District.

Completion of the landscaping in accordance with the approved landscape plan is required prior to final building inspection for works under a building permit where a landscape plan was required.

2.3 Drawings and Specifications

Drawings and specifications required for the review of proposed landscaping shall:

- a) be in duplicate, accurately dimensioned and at a suitable scale;
- b) show the location and dimensions of the parcel on which the landscaping is to occur;
- c) show the location and extent of proposed and existing buildings, structures, services, utilities and circulation, including paved and concrete surfaces;
- d) show the existing and proposed grades at a contour interval of 0.200 m and such grades shall be relevant to existing roadways and/or structures;
- e) show the location, size and species of all natural vegetation clearly indicating vegetation that shall remain and vegetation that shall be removed;
- f) show the location, size, quantity and species of all introduced vegetation;
- g) show the location, extent and materials of any proposed fencing;
- h) include sectional details including cross sections of the landscaping taken at sufficient locations to adequately illustrate the effect of landscaping, planting details, finishes and the location at which sectional details are taken is to be noted on a plan;
- i) include such other information as is necessary to illustrate all essential features and methods of planting and construction;
- j) include an outline of the proposed maintenance schedule.

2.4 Variations from Standards

Where the applicant wishes to vary from these standards, the applicant may submit a development variance permit application or development permit application.

2.5 Applicability⁶

Notwithstanding any other regulation in this Bylaw, the landscaping regulations and standards prescribed herein shall not apply to Electoral Area 'G' of the Regional District of Nanaimo

PART 3 - DESIGN

3.1 Design Standards - Landscape Screen

The following requirements shall be met in providing a landscape screen where required by this Bylaw:

- 1) A landscape screen shall provide at least seventy-five percent screening from grade level to a height of 2.0 m and at least twenty-five percent screening from the height of 2.0 m above grade to 5.0 m above grade, as illustrated in Table 1 of this Schedule.
- 2) The landscape screen shall include planting or retaining one evergreen tree for every 4 m of parcel frontage on a designated highway; such trees shall have a minimum height of 2.0 m and may be grouped or clustered.

⁶ Bylaw No. 500.360, adopted January 25, 2011

3.2 **Design Standards - Landscape Buffer**

The following requirements shall be met in providing a landscape buffer where required by this Bylaw:

- 1) A landscape buffer shall be a minimum of 5.0 m in width.
- 2) A minimum of 25% of the vegetation shall be evergreen shrubs with a minimum height of 0.5 m, and introduced shrubs shall be a minimum No. 5 pot (5 gallon) nursery standard at the time of planting.
- 3) The landscaping buffer shall include a minimum of one tree for every 10 m of parcel frontage, and such trees shall have a minimum height of 2.0 m and may be grouped or clustered.
- 4) A permanent curb of a minimum 15 cm in height shall be provided to protect landscaping from potential vehicular damage.
- 5) The use of a fence is to be accessory to the use of introduced vegetation, existing vegetation, a planted berm or any combination thereof in satisfying the requirements of a landscape buffer or landscape screen. Advertising display shall not be permitted on fences.

Fences shall be structurally sound and shall be designed and built to withstand wind and snow loads.

3.3 **Selection of Introduced Vegetation**

- 1) In the selection of introduced vegetation, species shall be selected which satisfy the requirements of screening and are adapted to the site specific conditions of the soil, climate and topography on which such vegetation is to be planted.
- 2) Individual plants to be used in landscaping shall have normal, well developed branches and vigorous fibrous root systems; such plants shall be healthy, vigorous and free from defects, decay, disfiguring roots, sunscald, injuries, abrasions of the bark, plant diseases, insect pests' eggs, borers and all forms of infestation or objectionable disfigurements.

3.4 **Planted Berms**

The sides of slopes of planted berms within proposed landscaped areas are to be within the following ranges:

Type of Planting	Minimum Slope	Maximum Slope
planted areas with greater than 70% ground cover	1:50	1:2
lawn and grass	1:50	1:3
planted areas with less than 70% ground cover	1:50	1:4

PART 4 - CONSTRUCTION

4.1 Timing

The coordination and scheduling of all work on the site shall be such that no damage occurs to introduced vegetation before or after installation or to natural vegetation to be retained or to existing soil conditions as determined by local weather conditions and the requirements of living plant material.

4.2 General

Imported topsoil shall be free from subsoil, roots, toxic materials, stones over 30 mm in diameter and foreign objects. Topsoil shall be free from crabgrass, couchgrass, equisetum or noxious weeds or seeds or parts thereof.

The working area shall be maintained in an orderly manner and shall not be encumbered with equipment, materials, or debris.

Clean up shall be a continuing process from the start of the work to final acceptance of the project. Property on which work is in progress shall at all times be kept free from accumulations of waste materials or rubbish. Accumulations of waste materials which might constitute a fire hazard shall not be permitted. Spillage from hauling vehicles on traveled public or private roads shall be promptly cleaned up. On completion of construction, all temporary structures, rubbish and waste materials resulting from the operations, shall be removed.

PART 5 - SECURITY DEPOSIT

5.1 Requirement

A security deposit shall be submitted to the Regional District for development permits which include landscaping and/or site improvement provisions.

The security deposit shall be submitted with the application prior to proceeding to the Electoral Area Planning Committee. A detailed planting plan as specified in Section 2.2 shall also be submitted at this time.

5.2 Type and Value of Security Deposit

The security deposit shall be in the form of either a standby irrevocable letter of credit, cash, or a certified cheque, or other acceptable equivalent, and shall be submitted in a form satisfactory to the Regional District.

The value of the security deposit shall be equal to the estimated total cost (i.e., materials and installation) of all of the required landscaping and/or site improvements. The total cost of these works shall be estimated as follows:

- a) \$50.00 per square metre of landscaping as indicated on submitted plans; and
- b) The cost of site improvements shall be determined by an itemized cost estimate of materials and installation. The cost estimate is to be completed by a professional landscape architect, a nursery person or landscape contractor or an equivalent agreed upon by the Regional District, and is to be submitted at the time of application. The developer assumes sole responsibility for undertaking and financing the cost estimate.

5.3 Release of Security Deposit

The security shall be released following the completion of all approved landscaping and/or site improvement works as specified in the development permit to the satisfaction of the Regional

District. A one-year written guarantee from a landscape contractor is also required, otherwise 25% of the landscaping cost will be retained to ensure proper maintenance for one year period.

In the event that the landscaping and/or site improvements are at variance with approved works and/or not completed to an acceptable standard and/or not completed within a specified time period, the Regional District may use the security deposit for the purpose of entering upon the subject property and completing the approved works and/or for pursuing any necessary legal or court judgment as required.

In the event that additional time is required to complete the landscaping and/or site improvements due to unforeseen circumstances, a written request shall be made to the Planning Department indicating the reason for an extension and the expected date of completion.

When a security deposit is in the form of a standby irrevocable letter of credit, it shall include provisions for its extension and/or renewal in the event that works cannot be completed before its expiry date. A minimum of 45 days notice of the need for an extension is required. Alternatively, and upon approval by the Regional District, a new standby irrevocable letter of credit with a revised expiry date shall be provided to the Regional District in these situations.

REGIONAL DISTRICT OF NANAIMO

BYLAW NO. 500

SCHEDULE '3F'

TABLE 1

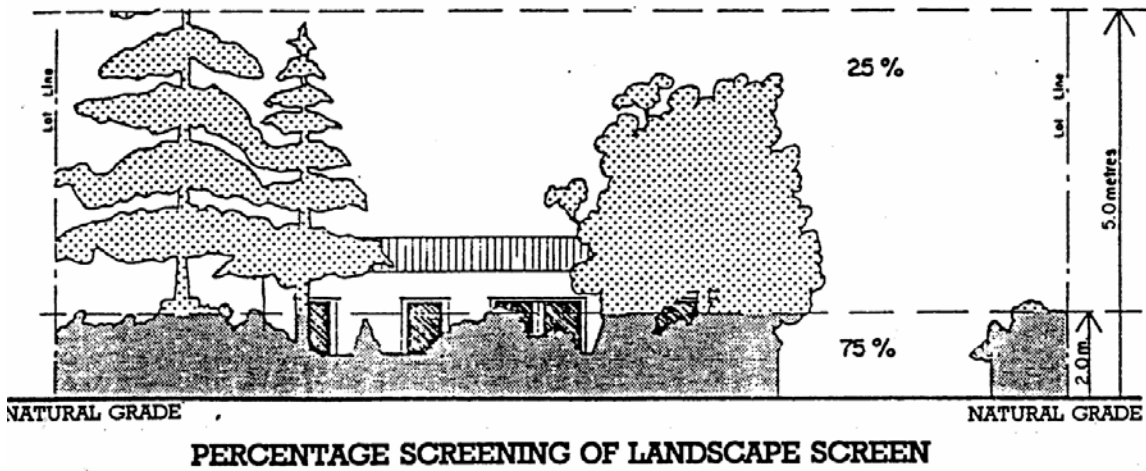
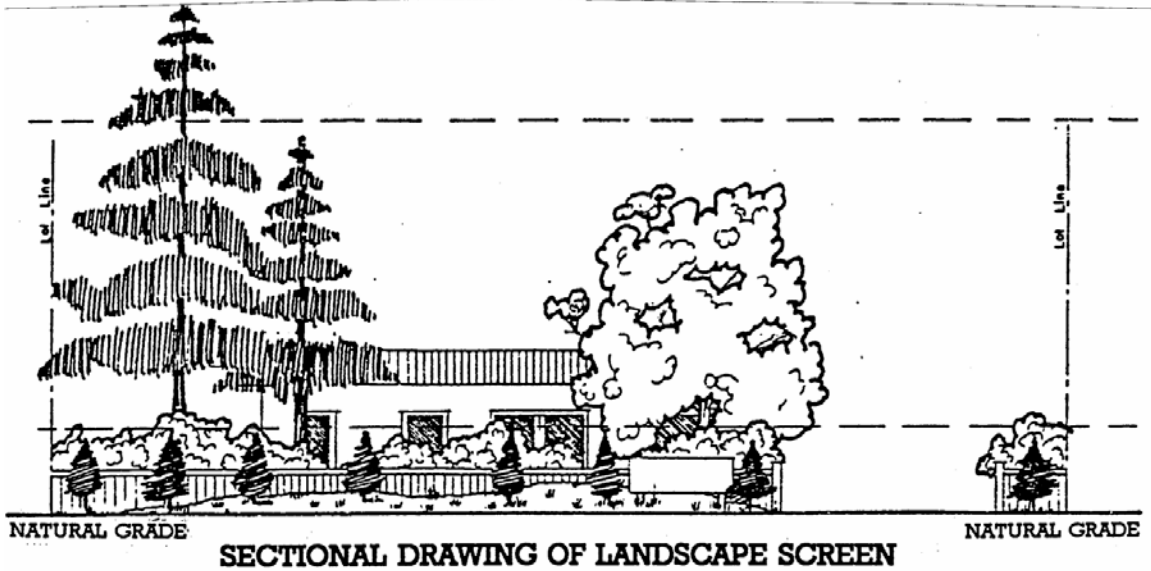

LANDSCAPING REGULATIONS

SCHEDULE '3F'

APPENDIX 1

ALPHABETICAL LIST OF DESIGNATED HIGHWAYS

Bennett Road, French Creek
Cedar Road, Cedar
Church Road, French Creek
Dolphin Drive, Nanoose
Eaglecrest Drive, French Creek
Fairwinds Drive, Nanoose
Industrial Road, Lantzville
Island Highway and service roads
Lantzville Road, Lantzville
Lee Road, French Creek
Lowrys Road, French Creek
Morningstar Drive, French Creek
MacMillan Road, Cedar
Northwest Bay Road, Nanoose and Parksville East
Parksville By Pass, Parksville East
Powder Point Road, Nanoose
School House Road, South Wellington
Trans Canada Highway, Cedar, Cranberry, Bright Area and
service roads
Wembley Road, French Creek
Yambury Road, French Creek

REGIONAL DISTRICT OF NANAIMO

BYLAW NO. 500

SCHEDULE '4A'¹

SUBDIVISION DISTRICT MAPS

¹ Bylaw No. 500.66, adopted December 12, 1989 (map replacement)

REGIONAL DISTRICT OF NANAIMO

BYLAW NO. 500

SCHEDULE '4B'

SUBDIVISION DISTRICTS

REGIONAL DISTRICT OF NANAIMO

BYLAW NO. 500

SCHEDULE '4B' SUBDIVISION DISTRICTS - MINIMUM PARCEL SIZES

- 1) The minimum size of any lot created by subdivision shall be determined by the standard of services provided and shall meet the applicable minimal parcel size set out below: ¹

Minimum Parcel Sizes				
Subdivision District	Community Water & Sewer System	Community Water System - No Community Sewer	Community Sewer System - No Community Water	All Other Subdivisions
A	20.0 ha	20.0 ha	20.0 ha	20.0 ha
B	8.0 ha	8.0 ha	8.0 ha	8.0 ha
C	5.0 ha	5.0 ha	5.0 ha	5.0 ha
CC ²	4.0 ha	4.0 ha	4.0 ha	4.0 ha
D	2.0 ha	2.0 ha	2.0 ha	2.0 ha
E	1.6 ha	1.6 ha	1.6 ha	1.6 ha
F	1.0 ha	1.0 ha	1.0 ha	1.0 ha
G	8000 m ²	1.0 ha	1.0 ha	1.0 ha
H	5000 m ²	1.0 ha	1.0 ha	1.0 ha
J ³	4000 m ²	6000 m ²	1.0 ha	1.0 ha
K	4000 m ²	4000 m ²	4000 m ²	4000 m ²
L	2000 m ²	2000 m ²	4000 m ²	4000 m ²
M	2000 m ²	2000 m ²	1.0 ha	1.0 ha
N ⁴⁵	1600 m ²	1600 m ²	1.0 ha	1.0 ha
P	1000 m ²	1600 m ²	1.0 ha	1.0 ha
Q (EA G only)	700 m ²	⁶ 1.0 ha	1.0 ha	1.0 ha
Q (other EAs)	700 m ²	2000 m ²	1.0 ha	1.0 ha
R	500 m ²	⁷ 1.0 ha	1.0 ha	1.0 ha
S ⁸	400 m ²	2000 m ²	1.0 ha	1.0 ha
T ⁹	600 m ²	No further subdivision		
V ¹⁰	50.0 ha	50.0 ha	50.0 ha	50.0 ha
Z	No further subdivision			
CD9 ¹¹	400 lots with approved pump and haul service connection			

¹ Bylaw No. 500.238, adopted February 10, 1998

² Bylaw No. 500.347, adopted September 22, 2009

³ Bylaw No. 500.27, adopted August 9, 1988

⁴ Bylaw No. 500.66, adopted December 12, 1989

⁵ Bylaw No. 500.324, adopted February 28, 2006

⁶ Bylaw No. 500.264, adopted October 10, 2000

⁷ Bylaw No. 500.264, adopted October 10, 2000

⁸ Bylaw No. 500.27, adopted August 9, 1988

⁹ Bylaw No. 500.394, adopted August 25, 2015

¹⁰ Bylaw No. 500.253, adopted January 11, 2000

¹¹ Bylaw No. 500.275, adopted October 9, 2001

REGIONAL DISTRICT OF NANAIMO

BYLAW NO. 500

SCHEDULE '4C'

COMMUNITY WATER SYSTEM STANDARDS

REGIONAL DISTRICT OF NANAIMO

BYLAW NO. 500

SCHEDULE '4C'

STANDARDS FOR PUBLIC WATER SYSTEMS

TABLE OF CONTENTS

1.	GENERAL.....	5
1.1	Requirement.....	5
1.2	Design	5
1.3	Application	5
1.4	Drawings and Specifications	6
1.5	Variations From Standards	7
1.6	Permits.....	7
1.7	New Service Areas.....	7
1.8	Existing Service Areas.....	7
1.9	Inspection	7
2.	DESIGN.....	7
2.1	Water Demand	7
2.2	Water Pressure.....	8
2.3	Design Population	8
2.4	Hydraulic Network	8
2.5	Water Quality	8
2.6	Supply Sources	9
2.7	Storage.....	10
2.8	Water Distribution Piping	11
2.9	Service Connections	12
2.10	Fire Hydrants	12
2.11	Valves.....	13
2.12	Fittings	14
2.13	Trenching and Backfill	14
2.14	Pressure Reducing Stations.....	14
2.15	Booster Pump Stations.....	15

3.	CONSTRUCTION.....	16
3.1	General	17
3.2	Existing Structures and Utility Works.....	18
3.3	Clearing.....	19
3.4	Trench Alignment and Depth.....	19
3.5	Pipe Installation	20
3.6	Trench Backfill	20
3.7	Repairs	20
4.	TESTING AND DISINFECTION.....	20
4.1	Written Reports.....	20
4.2	Leakage Tests	20
4.3	Flushing.....	21
4.4	Chlorination.....	21
4.5	Inspection	21

1. GENERAL

1.1 Requirement

Water supply and distribution systems shall be designed, installed, extended, tested and maintained in accordance with the following regulations and standards.

1.2 Design

The engineering design of the water system shall be carried out by, and the construction of drawings and specifications shall be sealed by, a registered Professional Engineer, and shall conform to these Standards.

1.3 Application

All applications shall be made in three steps as follows:

1) Feasibility Review

All proposed construction of water supply and distribution facilities shall be submitted to the Regional District for a feasibility review prior to commencement of any detailed design or construction. Such requests shall include a plan of the proposed construction and the area it will serve.

The Regional District will review the proposal, and reply with a written report indicating the District's decision regarding acceptance or rejection.

2) Detailed Design

The detailed design and specifications shall be submitted in duplicate to the Regional District for approval prior to construction.

The detailed plans will be returned either approved or with a request for re-submission. Re-submission will be carried out until the Regional District approves the detailed plans and specifications.

The District shall submit the detailed plans and specifications to the Provincial Ministry of Environment, approval from which is also a prerequisite to the start of construction.

3) Completion and Acceptance¹³

Once the work is completed, a statement signed by a registered Professional Engineer shall be submitted to the Regional District along with two sets of as-constructed drawings certifying that the project has been constructed under his supervision, and that it is completed in accordance with the as-constructed plans and specifications. One set of these as-constructed drawings shall be on 3 mil mylar material. This statement shall include a report on the leakage testing and chlorination of the system.

The Regional District shall then make a final inspection, and when it is satisfied the work is acceptable the applicant shall:

- a) guarantee the workmanship and the performance of the work for a period of one year by way of cash or an irrevocable letter of credit in the amount

¹³ Bylaw No. 500.13, adopted October 13, 1987

- of 5% of the cost of construction as certified by a professional engineer;
and
- b) convey the works to the Regional District.

Upon compliance with the above items, the Regional District shall issue a written statement that the new works can be connected to the District's existing system. Such connection shall be undertaken by the applicant under the direct supervision of the District or by the District at a cost to the applicant.

1.4 Drawings and Specifications

All drawings shall be ISO A1 size, 594 mm in depth and 841 mm in width. The following information shall be supplied:

- 1) **Location Plan** - showing the location of the proposed work. This may appear on the same sheet as the Key Plan.
- 2) **Key Plan** - showing a plan of the proposed work at a suitable scale such that the whole works are shown on one drawing, usually 1:5000, 1:2000 or 1:1000. The Key Plan shall show a general outline of the works, area covered and sheet numbers of the plan/profile drawings, and a legend showing existing and proposed works.
- 3) **Plans/Profiles** - showing detailed design of the proposed works. Profiles of mains 200 mm in size and under are not required unless otherwise specified by the Regional District.

Plans shall be drawn at a scale of 1:500 showing the location of the pipe centreline, pipe size and type and off-set from property line, hydrants, valves, fittings and all related appurtenances in relation to road, easement and adjacent property and lot lines. Existing or proposed underground utilities are to be indicated on the plan in addition to the extent of work required in making connection to existing water main. Location of service connections are to be shown. Connections not conforming to the standard offset require a distance from an iron pin or lot line. In general, water services shall be installed two in a trench at property corners, 1200 mm from the lot line, and alternate with hydro and telephone poles.

Profiles shall be drawn at a horizontal scale of 1:500 and a vertical scale of 1:50 if more suited to specific conditions. The profile shall show the line of the existing and finished road grade on centreline, the invert of the pipe, location of fittings and hydrants, and location of sanitary and storm utilities. Where the pipe is not to be laid at a constant depth below the finished grade, the invert elevation shall be shown at pipe deflections and vertical bends.

Drawings detailing plans and elevations shall be prepared for wells and wellheads, supply intake works, pump stations, major valve chambers, and storage reservoirs. Suitable standard scales shall be chosen, being either 1:50, 1:20, 1:10, or 1:5.

- 4) **Specifications** - shall be prepared to further define materials of construction and shall specify methods of construction and workmanship.
- 5) **As-Constructed Drawings** - shall be prepared by correcting drawings on completion of construction in order to reflect "as-built" conditions for permanent records. The location of all individual lot water service connections shall be clearly shown.

1.5 Variations From Standards

Where the applicant wishes to vary from these standards he shall submit a written request with adequate supporting data to the Regional District for review. The Regional District shall make the final decision as to the standard requirements which shall apply.

1.6 Permits

The applicant shall be responsible for obtaining all necessary approvals and permits required prior to construction of the water system other than the Environmental Engineering Division of the Ministry of Environment.

1.7 New Service Areas

Where a water system is to be constructed by an applicant within an area previously unserved by a community water system, the design and construction for the system shall comply with the requirements of these Standards.

1.8 Existing Service Areas

Where a water system is to be constructed by an applicant within the existing or extended boundaries of an area already being served by a community water system, the design and construction of the system shall comply with the requirements of these Standards, with the exception of Sections 2.5 and 2.6 which do not apply.

1.9 Inspection

The Director of Public Works of the Regional District or his appointed deputies shall be allowed access and provided adequate facilities for access to any part of the works at all times for the purpose of inspection.

Any connections to or interruption of any existing system will be under the direct supervision of the Regional District. Adequate notice to the Regional District of any such interruption to service shall be required in order that attendance by Regional District personnel can be arranged.

2. DESIGN

2.1 Water Demand

Water sources and primary supply mains shall be designed to supply the maximum day's demand, while distribution mains and booster pump stations must be sized to handle the peak hourly or fire flows. The volume of water in storage acts as a cushion between these differing flows.

The water distribution system shall be designed according to the following minimum demands:

1) Residential

Average daily per capita	0.48 m ³
Maximum daily per capita	1.18 m ³
Maximum peak per capita	1.93 m ³

2) Commercial and Industrial

Water demands for developments involving commercial or industrial zoned lands shall be in accordance with good engineering practice as determined by the Regional District.

3) Fire

Required fire flows shall be in accordance with the "Water Supply for Public Fire Protection - A Guide to Recommended Practice" as published by Public Fire Protection Survey Services.

2.2 Water Pressure

Minimum design distribution pressure in all areas at peak demand shall be 275 kPa. With the combination of maximum daily demand and the specified fire flow, the minimum residual water pressure at the fire hydrant shall be 138 kPa. Where these minimum design pressures cannot be maintained due to an increase in elevation or distance from the point of connection, a booster pump station and emergency storage shall be provided as part of the distribution system.

The maximum allowable distribution line pressure is 900 kPa except where individual connections are permitted directly from trunk mains and where special precautions are taken. Otherwise, where distribution pressures will exceed 900 kPa due to a drop in elevation, a pressure reducing station shall be installed as part of the distribution system. Where distribution pressures exceed 550 kPa, occupants in the area shall be required to install individual pressure reducing valves. This valve shall be of an approved design and manufacture.

2.3 Design Population

Design populations used in calculating water demand shall be computed in accordance with the population predictions as determined by the Regional District or with the persons/hectare:

Multiple dwelling unit development	125 persons/hectare
Dwelling unit	30 persons/hectare

2.4 Hydraulic Network

Depending on the complexity and extent of the proposed distribution system, the Regional District may require a hydraulic network analysis diagram showing maximum design flows and pressures. If this information is required, it shall be stated at the time of the feasibility review and shall be submitted by the applicant with the detailed design application. The hydraulic network shall be designed to distribute the maximum design flows at the pressures specified in this Standard.

2.5 Water Quality

- 1) Water supplied to domestic consumers shall be of a quality meeting the standards set by the Environment Engineering Division of the Ministry of Environment.
- 2) All surface water supplies shall be chlorinated.
- 3) Groundwater sources may require chlorination, at the discretion of the Ministry of Environment.

2.6 Supply Sources

1) Groundwater Source

Where groundwater is to be the source of supply, a copy of the well driller's log shall be submitted, together with a copy of a well completion report certified by a professional engineer or a groundwater geologist. Wells shall be cased, with a stainless steel slotted screen selected following sieve analysis of aquifer material, and shall have a grouted surface casing. The completion report shall record results of well pump tests, and contain conclusions as to the capability of the source to meet the design demand with a 30% percent safety factor under conditions of zero surface recharge for 100 days. The well pump test shall consist of a minimum of 24 hours continuous pumping, but in no case less time than it takes to produce a stable water level in the well for an adequate period. The Regional District may call for a quantitative and qualitative report by a groundwater geologist where unusual conditions or results occur.

Wellhead piping shall consist of an air release valve, check valve, turbine flow meter, pressure gauge, and gate valve to throttle flows to recommend output. A hose bib shall be provided to permit periodic Ministry of Environment sampling. The wellhead building or enclosure shall be designed such that future access to the well is available for pump removal or well redevelopment. A means of monitoring static and pumping levels in the well shall be provided. Flow recording may be required for some installations.

Wellhead buildings or enclosures shall be designed to provide adequate heating and insulation, lighting and ventilation.

2) Well Pump Controls

Each pump shall have a combination motor starter with a motor circuit protector, a "hand-off-auto" selector switch, a green "pump run" pilot light, a red "pump failed" pilot light and an elapsed time meter.

Motor starters for submersible well pumps shall be equipped with quick-trip overload relays. Low level draw-down protection shall be provided utilizing electrodes suspended in the well. Restart of the pump shall be automatic when the water level in the well has recovered sufficiently, however, a red alarm light on the control panel shall require manual reset.

If the system consists of more than one pump, supplied from the same service, the control circuits shall be subdivided into branch circuits in such a manner as not to shut down the entire system if one pump circuit develops a fault. Also, time delays shall be provided to permit staggered re-start of the pumps after a power failure.

The pump control panel shall have protection against single-phasing and a red pilot light which will stay on until manually reset after a power failure.

If the system consists of more than one pump, an automatic alternator or manual lead pump selector switch shall be provided.

A single-pole, double-throw (SPDT) contact shall be provided for remote alarm purposes, which will be activated in the event of pump failure, motor overload, power failure of low well level. An external alarm light may also be required for some installations.

Signal cables for pump control shall be directly buried, either alongside connecting pipelines or in a separate trench, wherever feasible. Cable warning tape shall be installed in the trench over signal cables.

3) Surface Water Source

Where surface water is to be the source of supply a certification by a professional engineer shall be provided as to the adequacy of the source to meet the design demand with adequate safety factors, under conditions of normal low rainfall, and under conditions of zero rainfall for 100 days.

The applicant shall be responsible for obtaining any necessary water licenses in the amount of the design demand, and for meeting all the requirements of the Water Rights Branch, Ministry of the Environment, British Columbia.

Surface water inlet works are to be located to provide optimum water quality, and shall be suitably screened. Access is to be provided to the inlet point for maintenance purposes. Inlet piping shall include a flow meter, pressure gauge, gate valve and a hose bib located to permit periodic sampling. Chlorination shall be provided at a suitable location. Flow recording may be required for some installations.

2.7 Storage

1) Sizing

Reservoirs shall be sized to provide the greater of either

- a) storage volume to provide water to meet 66 percent of an average day's demand; or
- b) storage volume to provide water to meet the fire flow requirements plus 20 percent of a maximum day's demand.

2) Design

The materials and designs used for finished water storage structures shall provide stability and durability as well as protect the quality of the stored water. Steel structures shall follow the current AWWA Standards concerning steel tanks, standpipes, reservoirs, and elevated tanks wherever they are applicable. Other materials of construction shall be acceptable when designed in accordance with the Building Regulations of British Columbia and amendments thereto.

The foundation may be designed either with the bottom at ground level, bearing on a slab or ring beam or on legs with the bottom in an elevated position.

Foundation design shall be in accordance with Building Regulations of British Columbia and amendments thereto. A foundation or soils investigations report shall be submitted.

In addition to the seismic requirements of the Building Regulations of British Columbia due account shall be taken of the effects of both convective and impulsive forces generated by ground motion. Sufficient clearance shall also be provided between high water level and roof soffit to allow for wave generation.

The reservoir structure shall be designed to safely withstand all construction and operating loads.

Reservoirs shall be totally enclosed with adequate ventilation, screened and weather protected. Vents shall project above the highest anticipated depth of snow on the roof.

Wood and concrete reservoirs shall be provided with a roof access hatch served by internal and external ladders.

Steel reservoirs shall be provided with a roof access hatch served by an external ladder and low level access manhole.

Access ladders, safety cages, and platforms shall comply with the requirements of the Worker's Compensation Board. Fencing of the reservoir site may be requested by the Regional District.

An altitude gauge shall be provided at an elevation of 1.2 m above the reservoir foundation.

Inlet piping is to discharge into the reservoir above TWL elevation. A bell mouth outlet set 150 mm to 300 mm above the reservoir floor, a valved drain set at floor level, and an overflow pipe shall be provided.

Alarms requiring manual reset shall be provided to indicate reservoir high or low level. In a water system consisting of well or booster pumps, these alarms shall be transmitted along buried signal cables to a central location. Controls may utilize probes or transmitters. Where the reservoir is supplied via pumped water, pump start-stop controls will be required. The Regional District may require individual start-stop levels for each pump, or staggered pump start-stop on a time basis.

The Regional District may require the installation of flow meters, flow recording and level recording equipment on a reservoir.

2.8 Water Distribution Piping

1) Materials

Unless otherwise permitted, the following pipe materials shall be used for water distribution:

Material	Specifications
Asbestos Cement	AWWA C400
Steel Pipe	AWWA C200
Ductile Iron Pipe	AWWA C151
PVC Pipe	AWWA C900 - Class 150, DR 18 maximum

Steel pipe shall be coated and lined in accordance with AWWA C203. Ductile iron pipe shall be cement mortar lined in accordance with AWWA C104. Joints shall be rubber gasket in accordance with AWWA C111. Where corrosive soil conditions exist the Regional District may require special protection for the pipe. All pipe shall be designed for the maximum pressures and earth loading to which the pipe will be exposed, but in no case shall the design working pressure or class be less than 1030 kPa.

2) General Layout

Numerous trunk lines and secondary feeders shall be installed throughout the system. These mains must be large enough to deliver consumption and fire flow demands for the district served, and shall be spaced not more than 900 m apart and looped.

Minor distributors and pipes of the gridiron system shall be a minimum of 150 mm in diameter in residential districts with 150 mm diameter cross mains at intervals not exceeding 180 m. Where no longer lengths of pipe are necessary 200 mm diameter or larger intersecting main shall be used unless initial pressures are unusually high. 200 mm diameter pipe shall be used where dead ends or poor gridironing are likely to exist for a considerable period, or where the layout of the streets and the topography are not adapted to the above arrangement. Lines furnishing domestic supply only, and not serving hydrants, may be 100 mm diameter. Where a water main ends in a dead end, or a valve is normally closed, a fire hydrant or blow off shall be provided for flushing purposes. The blow pipe and valve shall be less than 65 mm. No blow off shall be connected to a sewer. Fire hose connection and cap shall be required at the end of the blow off.

In the high value districts, the minimum size shall be 200 mm diameter. Pipe of 300 mm diameter is to be used on major highways as identified in the Official Community Plans of the Regional District and for long lines not cross-connected.

2.9 Service Connections

Unless otherwise permitted, only the following materials may be used for service connections:

Material	Specifications
Soft Copper, Type K	ASTM B88
Plastic	ASTM D2666

In the larger sizes, the materials specified in Section 2.8 for water distribution may also be used.

Table 1 shows the general arrangement for water service connections. The minimum size of service connection is 20 mm diameter. Corporation stops shall be Mueller A-225 or approved equal. Curb stops shall be Mueller A-618 or approved equal, flared on the street side and female iron pipe on the property side. Drain holes in curb stops shall not be permitted. Curb boxes shall be Brooks 37 Series or approved equal with cover set at ground level. Curb stops shall be set on main side of the meter box to facilitate meter installation when required. Saddle clamps shall be used as specified by the manufacturer.

Water service connection locations shall be co-ordinated with B.C. Hydro and Power Authority and the B.C. Telephone Company to avoid any conflict with poles at the property lines of parcels.

2.10 Fire Hydrants

Hydrants shall be in accordance with AWWA C502, compression type. The minimum hydrant size shall be 150 mm diameter. The minimum depth of bury shall be 1.0 m. There shall be a minimum of two 65 mm house outlets and one pumper outlet 117.5 mm P4.23, outside diameter male outlet complete with caps per hydrant. One of the outlets shall have an independent shut-off. Opening for both the main hydrant valve and independent shut-off shall be to the left (counter-clockwise). Outlet threads shall conform to the British Columbia Fire Hose Thread Specification. Main valve spindle and outlet nuts shall be standard pentagon shape. Main valve spindle: pentagon in 45 mm circle. Independent spindle: square 16 mm x 16 mm. Drain outlets are to be provided.

Table 2 of this Schedule shows the general arrangement for the installation of hydrants. Connections shall not be less than 150 mm diameter. A gate valve will be provided on all connections between the hydrant and the main. Installations shall be in general accordance with AWWA M17.

Hydrant distribution shall be in general conformance with the aforementioned Standard of Municipal Fire Protection, but in all cases spacing shall be such that the maximum distance from a hydrant to the centre of any property measured along the centreline of the street is 75 m. Hydrants will be set in 6 m from the corner at any intersection to facilitate future widening or other street works.

2.11 Valves

Unless otherwise permitted, only the following valves shall be installed in the distribution system:

1) Gate Valves

Gate valves shall be in accordance with AWWA C500 and the following supplementary data:

- a) Gate valves shall have an iron body, brass mounted.
- b) Valves shall be the same size as the pipe in which they are installed, up to and including 300 mm diameter. In mains over 300 mm diameter, valves may be butterfly type.
- c) Valve ends shall be provided to fit the pipe.
- d) The position of the valve in line shall be vertical.
- e) Stem seals shall be O-ring.
- f) Valves shall open to the left (counter-clockwise).
- g) Gears will be required on valves 400 mm and larger. Gear cases shall be totally enclosed.
- h) Bypasses will be provided on valves 500 mm in diameter and larger.
- i) Valves shall have a 50 mm operating nut.

2) Rubber Seated Butterfly Valves

Rubber seated butterfly valves shall be in accordance with AWWA C504 and the following specifications:

- a) Valves shall be the same size as the pipe in which they are installed. Valves shall be of wafer style or short body flanged.
- b) Valve ends shall suit the pipe.
- c) Maximum nonshock shut off pressure shall be suitable for 1030 kPa, bubble tight.
- d) Valves shall be designed for the extreme maximum flows for both opening and closing.
- e) Shaft seals shall be O-ring type.
- f) Valve disks shall be ductile iron.
- g) Valve operators shall be suitable for buried installation and equipped with a standard operating unit.
- h) Valves shall open to the left (counter-clockwise).
- i) Operators are to be located on the side of the valve with the operating spindle in the vertical position.

In general, valves shall be located at intersections and shall be so positioned that no more than 150 m for high value district and 250 m for other areas are isolated in the case of line repairs. In larger trunk and feeder mains where no interconnections are made, the spacing of valves should not exceed 500 m.

Thrust blocking or other restraints shall be provided on all valves.

Where valves are located in the roadway, valve boxes shall be Nelson Type of cast iron and telescoping so the surface loads are not transmitted to the valve body of pipeline. A minimum of 300 mm of adjustment shall be available on all valve boxes. Cast iron hoods shall be provided on all gate valves 250 mm diameter or larger. In areas where there is no traffic, valve boxes may be as approved by the Regional District.

Valve markers shall be installed to indicate the location of all valves. These markers shall be constructed of 50 mm metal pipe painted sky blue and set in a concrete base. They shall extend 1 m above the ground surface. The markers shall be located 2 m from the property line opposite the valve and the distance to the valve is to be marked in black figures on a flattened upper portion of the marker.

2.12 Fittings

Fittings shall be designed for a minimum of 1030 kPa working pressure and shall be in accordance with AWWA C110. Ends shall be flanged or belled to suit pipe ends. Flanges shall conform in dimension and drilling to ASA B16.1, Class 125. Flange gaskets shall be of natural rubber and shall be 3mm thick with a layer of cotton on both sides. Thrust blocks shall be provided as shown in Figure 3. For sizes larger than 300 mm diameter, or where pressures exceed 1030 kPa, or where allowable soil bearing pressure is less than 100 kPa, separate thrust calculations shall be carried out for each fitting and separate details shown.

2.13 Trenching and Backfill

The standard trench section is shown in Table 4 of this Schedule. The nominal depth of cover shall be 1.2 m but in no case shall it be less than 1.0 m unless otherwise permitted by the Regional District. Water mains shall be located not less than 3 m from all sewer lines, unless otherwise permitted by the Regional District.

2.14 Pressure Reducing Stations

General requirements for pressure reducing stations shall be as follows:

- 1) A valved bypass shall be provided.
- 2) A surge relief valve shall be provided to release pressure in the event of a failure of the pressure reducing valve(s). The surge relief valve may be incorporated into the pressure reducing station or may be located at some other suitable location within the distribution system.
- 3) Pressure reducing valves shall be sized to provide adequate pressure control through all ranges of design flows. If necessary, two or more pressure reducing valves of varying sizes will be provided in the one station.
- 4) Each pressure reducing and surge relief valve will be provided with isolating valves and be installed so that individual components may be easily removed for repair or replacement.
- 5) The whole of the pressure reducing stations shall be enclosed in a reinforced concrete vault with a standard manhole cover and other opening large enough to remove the largest single piece of equipment in the station. Floor drains sloped at 2 percent shall be provided to keep the station dry at all times and shall not be

directly connected to any sewer. Drains to the surface are permissible if there is no risk of flooding. Otherwise, underground absorption pits or sump pumps will be required depending on site condition. A permanent access ladder will be installed.

- 6) Pressure gauges complete with snubbers shall be installed to register both upstream and downstream pressure.
- 7) Adequate strainers shall be supplied on the water used for controlling and regulating valves.

2.15 Booster Pump Stations

General requirements for booster pump stations shall be as follows:

- 1) A valved bypass shall be provided.
- 2) There shall be sufficient capacity so that, with the most important pump out of service, the station will be capable of supplying the maximum design flow.
- 3) It may be requested that provision be made to provide the maximum design flow during a power failure. Normally this will be accomplished by means of an elevated storage tank. Where this is not possible, emergency standby internal combustion engines shall be installed either for direct drive or electric generation.
- 4) Where design flows are such that starting and stopping surges will cause water hammer in the inlet or discharge lines, pump control valves or other pressure control devices shall be provided. Relief valves will also be required to protect against surges caused by power failure.
- 5) Pumps shall be controlled by automatic devices satisfactory to the Regional District. Flow and pressure measurement shall be provided where required. Flow recording may be required for some installations. Signal cable for pump control shall be directly buried, either alongside connecting pipelines or in a separate trench, wherever feasible. Cable warning tape shall be installed in the trench over signal cables.
- 6) Pumps shall normally be housed in above ground buildings, designed to provide adequate insulation, heating, lighting and ventilation.
- 7) Each pump shall have a combination motor starter with a motor circuit protector, a "hand-off-auto" selector switch, a green "pump run" pilot light, a red "pump failed" pilot light and an elapsed time meter.

If the system consists of more than one pump, supplied from the same service, the control circuits shall be subdivided into branch circuits in such a manner as not to shut down the entire system if one pump circuit develops a fault. Time delays shall be provided to permit staggered re-start of the pumps after a power failure.

The pump control panel shall have protection against single-phasing and a red pilot light which will stay on until manually reset after a power failure.

If the system consists of more than one pump, an automatic alternator or a manual lead pump selector switch shall be provided. Time delays or other means suitable to prevent hunting on momentary pressure surges shall be provided.

The pumps shall be shut down and stay locked in the event of motor high temperature or motor overload. The pumps shall also shut down on low suction pressure, however, re-start shall be automatic when the section pressure recovers, except that a red pilot light shall stay on until manually reset.

A single-pole, double-throw (SPDT) contact shall be provided for remote alarm purposes, which will be activated in the event of pump failure, motor high temperature, motor overload, low suction pressure, power failure or standby engine failure (if applicable). An external alarm light may also be required for some installations.

3. CONSTRUCTION

3.1 General

1) Access Roads

Temporary roads shall be constructed as required for access to the working areas. Adequate drainage facilities in the form of ditches, culverts, or other conduits shall be installed as found necessary to maintain these roads. In the construction of access roads, existing drainage facilities, natural or otherwise, shall not be disturbed to the detriment of properties outside the working area and such facilities shall, unless otherwise provided elsewhere in the specifications, be restored to their original condition on completion of the work.

2) Sanitary Facilities

Clean, sanitary latrine accommodations shall be provided and shall be located and maintained in accordance with the regulations of the Ministry of Health.

3) Special Tools, Operating Manuals, Shop Drawings

With each piece of mechanical and electrical equipment or machinery having wearing parts and requiring periodical repair and adjustment, all special tools, wrenches, and accessories required for removing worn part, making adjustments, and carrying out maintenance shall be supplied. All gauges, indicators, and lubricating devices necessary for the proper operation of the equipment shall be furnished.

With each piece of equipment, 4 sets of operating manuals and as-constructed shop drawings, shall be supplied. The manuals shall provide the manufacturer's recommended maintenance schedules with the grades of lubricants required, and instructions as to how the equipment may be taken apart for periodical inspection and replacement.

4) Blasting

Blasting will be permitted only after securing the approval of the applicable authorities. Blasting will not be carried out without first verifying that insurance covers any loss of life or damage that may result from this work. The Regional District, in granting approval for blasting, does not in any way assume responsibility for injury, loss of life, or damage that result therefrom, and such approval shall not be construed as approval of the methods employed in blasting, the sole responsibility therefore being that of the applicant.

5) Site Maintenance and Clean Up

The working area shall be maintained in an orderly manner and shall not be encumbered with equipment, materials, or debris.

Clean up shall be a continuing process from the start of the work to final acceptance of the project. Property on which work is in progress shall at all times be kept free from accumulations of waste materials or rubbish. Accumulations of waste materials, which might constitute a fire hazard, shall not be permitted. Spillage from hauling vehicles on traveled public or private roads shall be promptly cleaned up. On completion of construction, all temporary structures, rubbish, and waste materials resulting from the operations, shall be removed.

3.2 Existing Structures and Utility Works

1) Scope

Existing structures shall be interpreted as being all existing pipes, ducts, ditches, or other works forming a part of sewerage, drainage, water, telephone, electrical, gas, or other utility system, as well as sidewalks, curbs, poles, fences, buildings, and other man-made things that may be encountered during construction.

2) Material Supply

Unless specified otherwise, materials supplied for replacement of existing structures shall be at least equal to those being replaced.

3) Location of Structures

Drawings or descriptions, verbal or otherwise, of existing structures or their location that are supplied by the Regional District are intended only as an aid to locating these structures. Measurements and location of the existing underground structures shown on the drawings are not guaranteed to be accurate, and must be verified prior to proceeding with construction.

4) Protection of Structures

Unless authorization from the Regional District is received for their removal, underground and surface structures encountered during construction shall be protected from damage. In the event of damage resulting from the construction operation, structures shall be repaired or replaced to a condition, which is at least the equivalent of that which existed prior to construction.

5) Emergency Situations

In emergency situations resulting from the construction operation, where life or property are endangered, the applicant shall immediately take whatever action is possible to eliminate the danger, and shall also notify the Regional District of the situation.

6) Access Maintained

Existing hydrants, valve or control pit covers, valve boxes, curb stop boxes, fire or police call boxes, and all other utility controls, warning systems, and appurtenances thereof shall not be constructed or made inaccessible at any time by the construction work. Bridges, walks, or other temporary facilities shall be provided as may be necessary to ensure that these controls or warning systems are free for use in their normal manner at all times during construction.

7) Curtailment of Utility Service

Where existing utilities such as water, sewer, electricity, telephone, and gas are serving the public, work shall be planned and executed such that there is no curtailment of service provided by these utilities without prior receipt of approval of the authorities responsible for provision and maintenance of these utilities. The applicant shall obtain the above approvals from the recognized authorities controlling these utilities. If approval for such disruption of utility service is not granted, it may be possible to establish temporary facilities to provide continuous utility service during the course of construction. Such temporary facilities shall only be implemented after receiving the approval of the utility authority.

If approval is received to temporarily shut off an existing utility, individual users of the utility shall be notified at least one hour prior to the time of shut-off.

If there is going to be a shut-off, the Fire Department shall be notified at least one hour prior to shut-off time.

8) Support of Structures

Existing structures shall be protected against damage from settlement by means of timber support or compaction of backfill as required. Where necessary, timber support shall remain in place following backfill of excavations.

Backfill which is placed under or adjacent to the existing structures, which have been undermined during excavation shall be compacted in a manner which will prevent damage of the structure from settlement. Such backfill shall be of approved granular material suitable for compaction.

On existing piping, this material shall extend horizontally a minimum distance of 600 mm on both sides of the pipe at a level 300 mm above the pipe, and shall slope down from this point at 1-1/2 horizontal to 1 vertical to meet the bottom of the excavation.

Drainage Facilities

Existing culverts, enclosed drains, flumes and ditches, and other drainage structures affected by the work but left in place shall be kept clear of excavated material at all times during construction. When it is necessary to temporarily remove an existing drainage structure, suitable temporary ditches or other approved means of handling the drainage shall be provided during construction.

3.3 Clearing

Prior to clearing, the exact limits of the areas on which clearing may take place and whether or not there are restrictions placed on clearing which would result in leaving certain trees, structures, or other existing items in place shall be ascertained.

Prior to trenching, the right-of-way shall be cleared of all standing or fallen brush, timber, stumps, or other debris, which may obstruct the construction operation, damage the completed installation, or detract from the appearance of the site on completion of construction. This material shall be burned or otherwise disposed of to the satisfaction of the Regional District.

The restrictions of all authorities established to control burning in the area shall be complied with. If burning cannot be done on the clearing site, the material shall be hauled to an approved location for burning or disposal. Burning permits, as required, shall be obtained by the applicant.

3.4 Trench Alignment and Depth

Following clearing and prior to excavation of the trench, the location at which the pipe shall be installed shall be established by setting stakes at 20.0 m intervals along a line offset from the centre of the proposed pipeline.

Where pipe is to be installed to a predetermined grade, a cut sheet will be provided showing the depth of the pipe invert relative to the grade stake elevation at the respective locations along the pipeline.

The trench shall be excavated so that pipe can be laid to the established alignment and depth, with allowance made for specified trench wall clearances and bedding as shown in Table 4 or otherwise required.

All trenching and excavations shall be carried out in the manner recommended by the Workers' Compensation Board of British Columbia, or as may be necessary to protect life, property, and structures adjacent to the work and the work itself.

3.5 Pipe Installation

In general, and without limiting the clauses set out in this Standard, pipe shall be installed in accordance with the following specifications:

Ductile Iron Main	AWWA C600
Asbestos Cement Main	AWWA C603
Steel Mains	AWWA C603
PVC Mains	AWWA C900

3.6 Trench Backfill

Trench backfill shall be carried out as shown in Table 4.

3.7 Repairs

Any system approved and built to these standards which requires maintenance work, shall be repaired with materials and construction methods conforming to the specifications contained herein.

4. TESTING AND DISINFECTION

4.1 Written Reports

The applicant shall submit reports to the Regional District certified by a professional engineer of the tests and chlorination requirements specified herein.

4.2 Leakage Tests

Following final trench backfilling, leakage tests shall be performed on all installed piping.

Leakage tests shall be carried out between valved sections of the installation such that every valve in the system is tested for leakage in the shut-off position.

Leakage tests shall be performed in the following manner. The section to be tested shall be filled with water and all air expelled from the piping. It is recommended that the test section be filled with water for at least 24 hours prior to testing. By pumping water into the test section, the pressure within the piping shall be increased to 0.7 MPa, or 1-1/2 times the system operating pressure at the point of test, whichever is the greater. This pressure shall be maintained constantly in the pipe throughout the duration of the test by the addition of make-up water. The duration of the test section to maintain the specified pressure over the period of test shall be considered to be the leakage.

Piping will not be accepted until the leakage is less than the maximum allowable leakage determined from the following formula:

$$L = ND \times \text{the square root of } P$$

in which

- L = the allowable leakage in litres per hour,
- N = the number of joints in the test section,
- D = the nominal diameter of the pipe in millimetre, and
- P = the average test pressure during the leakage test in megapascals.

Should any test disclose leakage greater than that specified above, the defect shall be located and repaired, and the section shall be retested to ensure that the leakage is within the allowable limits.

4.3 Flushing

The pipe shall be cleaned of dirt and other foreign materials. The pipe shall be flushed at water velocities of 1.0 m/s, or as high a velocity as can be obtained from the available water sources. Flushing water shall be discharged to watercourses or ditches that have sufficient capacity to carry the flow.

4.4 Chlorination

On completion of the flushing operation, main pipes and services shall be chlorinated. Chlorination procedures shall conform to AWWA C601.

On completion of chlorination, the entire piping system shall be thoroughly flushed, filled with water, and left in a condition ready for use.

Water reservoirs and storage tanks shall be disinfected in accordance with AWWA D102.

Chlorinated water shall be disposed of in such a way as to not cause harm or damage to vegetation or aquatic life in bodies of water or water courses.

4.5 Inspection

The Regional District shall be given 48 hours notice of all tests and chlorination.

REGIONAL DISTRICT OF NANAIMO

BYLAW NO. 500

SCHEDULE '4C'

TABLE 1

WATER SERVICE CONNECTIONS DETAILS

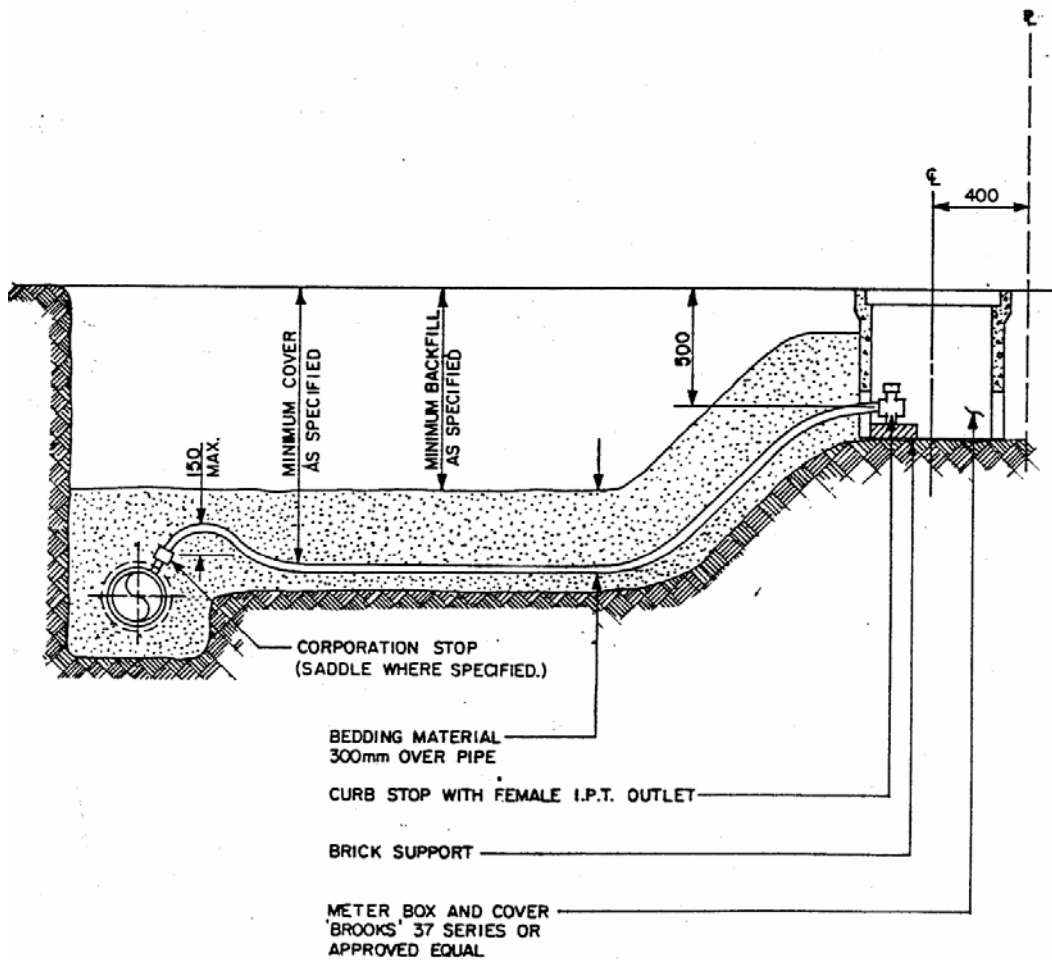

NOTE: ALL DIMENSIONS ARE IN MILLIMETRES

REGIONAL DISTRICT OF NANAIMO

BYLAW NO. 500

SCHEDULE '4C'

TABLE 2

HYDRANT CONNECTION DETAILS

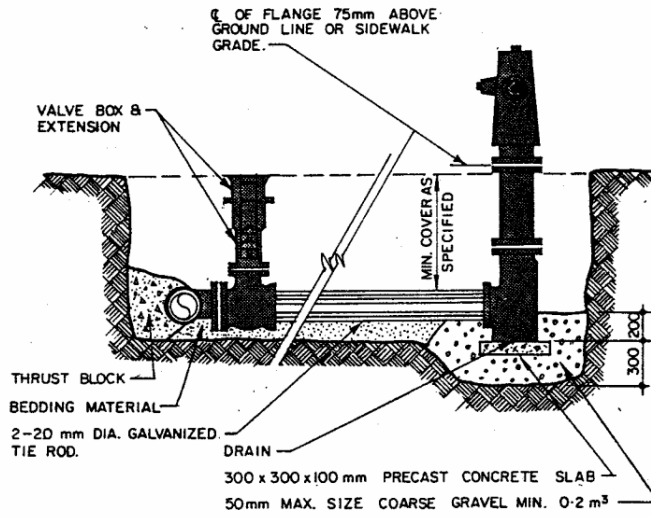

HYDRANT CONNECTION WITH TIE RODS

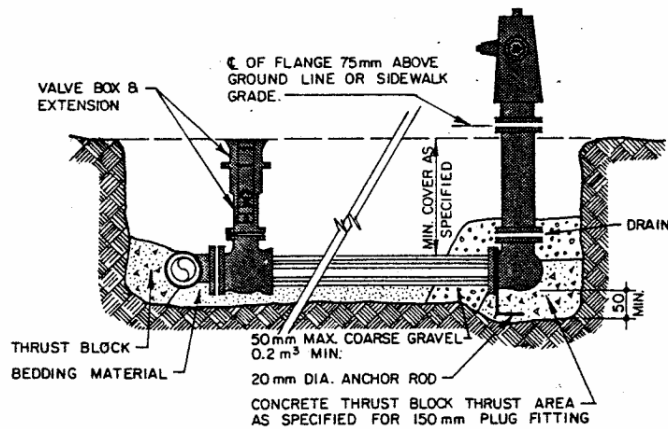

HYDRANT CONNECTION WITH THRUST BLOCK

- NOTES :
1. HOSE AND PUMPER NOZZLE MUST FACE CURB.
 2. WHEN MAIN IS BETWEEN HYDRANT AND PROPERTY LINE, HYDRANT MUST BE A SPECIAL ORDER.
 3. ALL DIMENSIONS ARE GIVEN IN MILLIMETRES UNLESS OTHERWISE INDICATED.

REGIONAL DISTRICT OF NANAIMO

BYLAW NO. 500

SCHEDULE '4C'

TABLE 3

THRUST BLOCK DETAILS

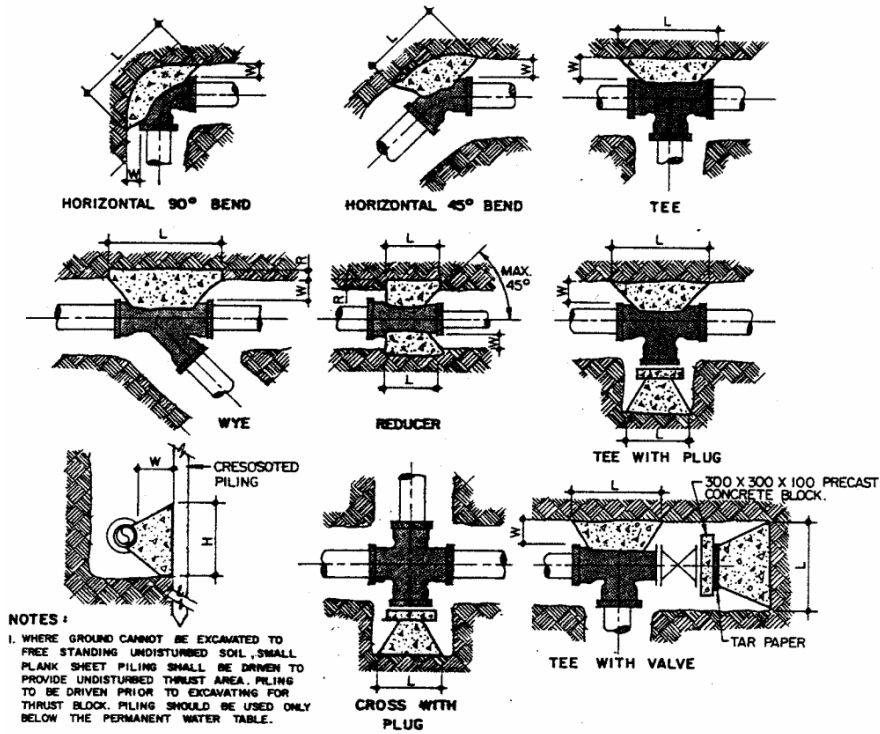

NOTES:
 1. WHERE GROUND CANNOT BE EXCAVATED TO FREE STANDING UNDISTURBED SOIL, SMALL PLANK SHEET PILING SHALL BE DRIVEN TO PROVIDE UNDISTURBED THRUST AREA. PILING TO BE DRIVEN PRIOR TO EXCAVATING FOR THRUST BLOCK. PILING SHOULD BE USED ONLY BELOW THE PERMANENT WATER TABLE.
 2. ALL DIMENSIONS ARE GIVEN IN MILLIMETRES UNLESS OTHERWISE INDICATED.

MINIMUM THRUST AREAS FOR FITTINGS AT 1030 kPa PRESSURE AND FOR SOILS WITH MIN. BEARING OF 96 kPa (NOT TO BE USED FOR SOFT CLAY, MUCK, PEAT ETC.)															
TYPE OF FITTING	FITTING SIZE	OUTSIDE OF FITTING TO BEARING FACE		RECESS IN TRENCH WALL		LENGTH	HEIGHT	TYPE OF FITTING	FITTING SIZE	OUTSIDE OF FITTING TO BEARING FACE		RECESS IN TRENCH WALL		LENGTH	HEIGHT
		D	W	R	L					H	D	W	R		
90° BEND	150	100		920	460			CROSS	150	300		610	460		
	200	350		1070	610				200	350		760	610		
	250	380		1450	760				250	380		990	760		
	300	400		1650	820				300	400		1220	920		
45° BEND	150	300		460	460			45° WYE	150	100	300	460	460		
	200	350		610	610				200	350	400	610	610		
	250	380		760	760				250	380	500	760	760		
	300	400		920	920				300	400	600	920	920		
22 1/2° BEND	150	300		460	230			REDUCER	150	300	150	460	460		
	200	350		610	300				200	350	200	610	610		
	250	380		840	460				250	380	250	760	760		
	300	400		920	460				300	400	300	920	920		
TEE	150	300		610	460			CAPS AND PLUGS (IF NOT BOLTED)	150	300		460	460		
	200	350		760	610				200	350		610	610		
	250	380		990	760				250	380		760	760		
	300	400		1220	920				300	400		920	920		

REGIONAL DISTRICT OF NANAIMO

BYLAW NO. 500

SCHEDULE '4C'

TABLE 4

TRENCH DETAILS

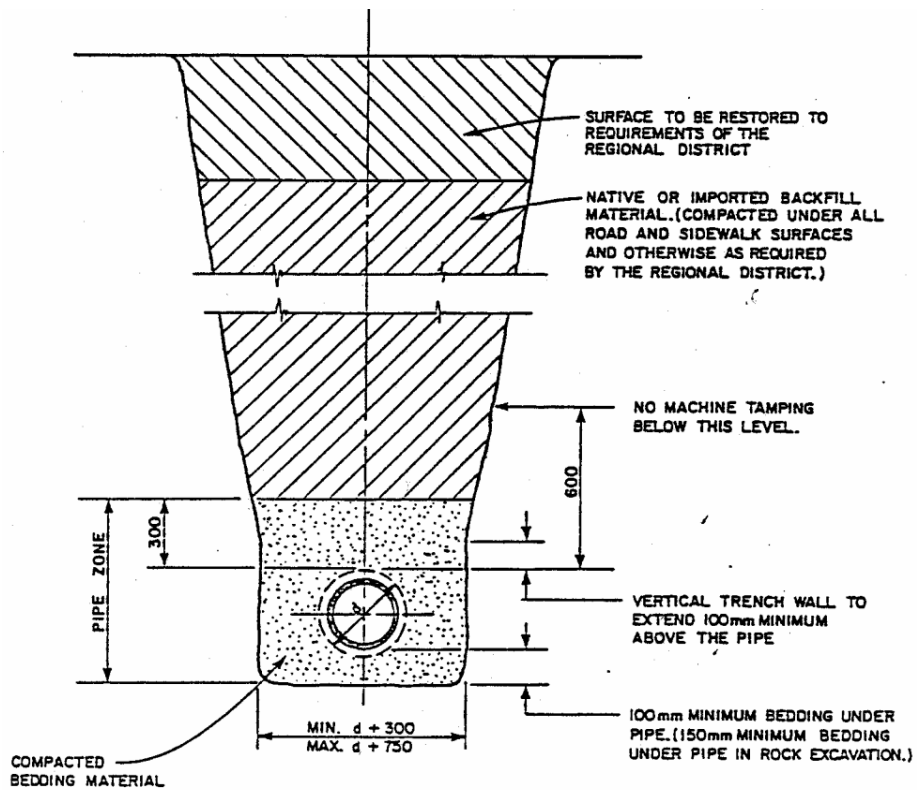

NOTES:

1. d = THE OUTSIDE DIAMETER OF THE PIPE AT ITS LARGEST SECTION.
2. ALL DIMENSIONS ARE IN MILLIMETRES

REGIONAL DISTRICT OF NANAIMO

BYLAW NO. 500

SCHEDULE '4C1'¹⁴

2013 LAKES DISTRICT AND SCHOONER COVE

COMMUNITY WATER SYSTEM STANDARDS

¹⁴ Bylaw No. 500.388, adopted July 22, 2014

REGIONAL DISTRICT OF NANAIMO
BYLAW NO. 500
SCHEDULE 4C1
LAKES DISTRICT AND SCHOONER COVE
COMMUNITY WATER SYSTEM STANDARDS
TABLE OF CONTENTS

1.	GENERAL	4
1.1	Requirement	5
1.2	Design.....	5
1.3	Definitions	5
1.4	Application	5
1.5	Drawings and Specifications	6
1.6	Variations from Standards	7
1.7	Permits	7
1.8	New Service Areas.....	7
1.9	Existing Service Areas.....	7
1.10	Inspection.....	8
2.	DESIGN.....	8
2.1	Water Demand.....	8
2.2	Water Pressure	9
2.3	Design Population	9
2.4	Hydraulic Network	10
2.5	Water Quality.....	10
2.6	Supply Sources	10
2.7	Storage	14
2.8	Water Distribution Piping	15
2.9	Service Connections	16
2.10	Fire Hydrants.....	18
2.11	Valves	18
2.12	Fittings.....	19
2.13	Trenching and Backfill	19
2.14	Pressure Reducing Stations.....	21
2.15	Booster Pump Stations.....	21
2.16	Water Meter Chambers	23
3.	CONSTRUCTION	23
3.1	General.....	23
3.2	Existing Structures and Utility Works.....	24
3.3	Clearing	26

3.4	Trench Alignment and Depth.....	26
3.5	Pipe Installation	27
3.6	Trench Backfill.....	27
3.7	Repairs.....	27
4.	TESTING AND DISINFECTION.....	27
4.1	Written Reports	27
4.2	Leakage Tests	27
4.3	Flushing	28
4.4	Chlorination.....	28
4.5	Inspection.....	28
5.	TRANSFERRING THE WATER SYSTEM TO THE RDN.....	29
5.1	Final Inspection by RDN	29
5.2	Preparation/Execution of Transfer Agreement by Developer.....	29
5.3	Preparation/Execution of Maintenance Agreement	29
5.4	Preparation/Execution of Latecomer Agreement.....	29
5.5	Letter of Acceptance of the Works by RDN	29

APPENDICES

Appendix 1	Standard Drawings
Appendix 2	Letter of Assurance
Appendix 3	Certificate of Design
Appendix 4	Certification of Installed Works
Appendix 5	Outline for Wellhead Protection Report
Appendix 6	Standby Irrevocable Letter of Credit

1. GENERAL

1.1 Requirement

The water standards for design and construction of the water system within the Lakes District and the Schooner Cove Community Water Standards Area are to be governed by Regional District of Nanaimo Land Use and Subdivision Bylaw No. 500, 1987, and particular by this Schedule 4C1.

It is the intention of the RDN to enter into a phased development agreement under section 905.1 of the *Local Government Act* with the property owner of the lands within the Lakes District Comprehensive Development Zone CD44 and the Schooner Cove Comprehensive Development CD45 that will specify changes to specified subdivision servicing bylaw provisions that would not apply to the development contemplated under that agreement, unless agreed to in writing by the developer.

The RDN will require a Subdivision Service Agreement to be completed for any new water system or existing system extension, unless otherwise agreed to in writing by the RDN.

Water supply and distribution systems shall be designed, installed, extended, tested and maintained in accordance with the following standards and specifications.

1.2 Design

The engineering design of the water system shall be carried out by, and the preparation of drawings and specifications shall be sealed by a Professional Civil Engineer registered in the Province of British Columbia (the Design Professional), and shall conform to these Standards.

1.3 Definitions

Engineer means the Manager of Engineering Services for the Regional District of Nanaimo, or the person designated by the General Manager of Regional and Community Utilities.

Engineer of Record means a Professional Engineer registered with the Association of Professional Engineers and Geoscientists of BC who is responsible for the construction drawings and documents. The Engineer of Record will be the engineer that signs and seals the record drawings and Certification of Installed Works.

Facilities means water lines, water treatment plants, pumping stations and other works necessary thereto, and for carrying potable water and includes any and all works, structures, lands, conveniences, incidental to and necessary for a water system.

Member Municipality or Member means a municipality or improvement district within the Regional District of Nanaimo.

Regional District means in the document the Regional District shall refer to the Regional District of Nanaimo.

1.4 Application

All applications shall be made in two steps as follows:

1. Feasibility Review

All proposed construction of water supply and distribution facilities shall be submitted to the Regional District for a feasibility review prior to commencement of any detailed design or construction. Such requests shall include a plan of the proposed construction and the area it will

serve. The applicable feasibility review fee, in accordance with RDN Bylaw No. 1259.03 or most recent amendment, and the Letter of Assurance shall also be submitted at this time.

The Regional District will review the proposal, and reply in writing indicating approval or listing the necessary amendments required.

To be addressed but not limited to, are the following items:

- a) source of water
- b) initial plan of the works showing equipment/pipe sizes, materials etc.
- c) number of properties and population served
- d) alignments/offsets of pipes etc.
- e) any flow and/or pressure concerns

2. Detailed Design

The detailed design and specifications shall be submitted in duplicate to the Regional District for Design Stage Approval (DSA) prior to construction and is valid for up to 180 days from the date of issue. Attached to the submission shall be a Certificate of Design. The applicable engineering review fee, in accordance with RDN Bylaw No. 1259.03 or most recent amendment, shall also be submitted at this time, along with the Design Professional's certified cost estimate for the works upon which the fee amount is based.

The detailed plans will be returned either approved or with a request for re-submission. Re-submission will be carried out until the Regional District approves the detailed plans and specifications, and issues Design Stage Approval (DSA).

The Design Professional shall submit the RDN approved plans to the Provincial Ministry of Transportation & Infrastructure and Vancouver Island Health Authority for any approval permits that may be required. Receipt and submission of these permits to the RDN shall also be a prerequisite to the start of construction. Approval permits from other applicable agencies as required shall also be obtained.

1.5 Drawings and Specifications

All design drawings shall be ISO A1 size, 594 mm in depth and 841 mm in width. The following information shall be supplied:

- 1. Location Plan** - showing the location of the proposed work. This may appear on the same sheet as the Key Plan.
- 2. Key Plan** - showing a plan of the proposed work at a suitable scale such that the whole works are shown on one drawing, usually 1:5000, 1:2000 or 1:1000. The Key Plan shall show a general outline of the works, area covered and sheet numbers of the plan/profile drawings, and a legend showing existing and proposed works.
- 3. Plans/Profiles** - showing detailed design of the proposed works. Profiles of mains 200 mm in size and under are not required unless otherwise specified by the Regional District.

Plans shall be drawn at a scale of 1:500 (1:250 is also acceptable), showing the location of the pipe centreline, pipe size and type and off-set from property line, hydrants, valves, fittings and all related appurtenances in relation to road, easement and adjacent property and lot lines. Existing or proposed underground utilities are to be indicated on the plan in addition to the extent of work required in making connection to existing

water main. Location of service connections are to be shown. Connections not conforming to the standard offset require a distance from an iron pin or lot line. In general, water services shall be installed two in a trench at property corners, 1200 mm from the lot line, and alternate with hydro and telephone poles.

Profiles shall be drawn at a horizontal scale of 1:500 and a vertical scale of 1:50 if more suited to specific conditions. The profile shall show the line of the existing and finished road grade on centreline, the invert of the pipe, location of fittings and hydrants, and location of sanitary and storm utilities. Where the pipe is not to be laid at a constant depth below the finished grade, the invert elevation shall be shown at pipe deflections and vertical bends.

Drawings detailing plans and elevations shall be prepared for wells and wellheads, supply intake works, pump stations, major valve chambers, and storage reservoirs. Suitable standard scales shall be chosen, being either 1:50, 1:20, 1:10, or 1:5.

4. **Specifications** - shall be prepared to further define materials of construction and shall specify methods of construction and workmanship.
5. **Record Drawings** - shall be prepared by correcting drawings on completion of construction in order to reflect "as-built" conditions for permanent records. The location of all individual lot water service connections shall be clearly shown. The drawings shall be signed and sealed by the Professional Civil Engineer, and shall be accompanied by a Certification of Installed Works. Final record drawings shall consist of:
 - a) 2 full-size paper sets;
 - b) one full size 3 mil Mylar set;
 - c) 2 – 11" X 17" paper sets or 2 A3 half-size paper sets, as agreed by the RDN; and
 - d) digital copies, one as AutoCAD or Civil 3D file as applicable to the current software, and one as TIFF files.

1.6 Variations from Standards

Where the applicant wishes to vary from these standards he shall submit a written request with adequate supporting data to the Regional District for review.

The Regional District shall make the final decision in writing as to the standard requirements which shall apply.

1.7 Permits

The applicant shall be responsible for obtaining all necessary approvals and permits required prior to commencing construction of the water system.

1.8 New Service Areas

Where a water system is to be constructed by an applicant within an area previously unserved by a community water system, the design and construction for the system shall comply with the requirements of these Standards, unless otherwise agreed to in writing by the Regional District.

1.9 Existing Service Areas

Where a water system is to be constructed by an applicant within the existing or extended boundaries of an area already being served by a community water system, the design and construction of the system shall comply with the requirements of these Standards, with the

understanding that Sections 2.5 and 2.6 may not apply and will be determined by the RDN according to the project and available existing source capacity and water quality.

1.10 Inspection

The Manager of Engineering Services of the Regional District or his appointed deputies shall be allowed access and provided adequate facilities for access to any part of the works at all times for the purpose of inspection.

Any connections to or interruption of any existing system will be under the direct supervision of the Regional District. Adequate notice to the Regional District of any such interruption to service shall be provided in order that attendance by Regional District personnel can be arranged.

The design engineer appointed by the Developer/Owner shall be employed during construction of the works to confirm the project is/has been constructed according to the design drawings and specifications. At the end of the project the engineer shall provide a Certification of Installed Works indicating the works were constructed according to the plans and specifications and meet all applicable codes / regulations / bylaws.

2. DESIGN

2.1 Water Demand

Water sources and primary supply mains shall be designed to supply the maximum day's demand, while distribution mains and booster pump stations must be sized to handle the peak hourly or fire flows. The volume of water in storage acts as a cushion between these differing flows.

The water distribution system shall be designed according to the following minimum demands:

1. Residential

Replacement Section 2.1.1 Water Demand - Residential

Housing Unit	Max Litres per Day per Person	Max Imperial Gallons per Day per Person	Persons Per Household	IGPM per Housing Unit
		(A)	(B)	(A/24/60XB)
Single-Family/detached house	1,168	250	2.2	0.38
Townhouse (attached, semi-detached) unit	914	200	1.9	0.26
Apartment / condominium unit	424	90	1.4	0.09
Secondary suite (carriage house)	424	90	1.1	0.07
Seniors Living unit	424	90	1.1	0.07

2. Commercial and Industrial

Water demands for developments involving commercial or industrial zoned lands shall be in accordance with good engineering practice as determined by the Design Professional and approved in writing by the Regional District.

Replacement Section 2.1.2 Water Demand - Commercial

Non-residential uses			
Commercial – Retail	480	105	Per 1000 sf leasable
Commercial – Office	640	140	Per 1000 sf leasable
Commercial – Restaurant	3500	770	Per 1000 sf leasable
Commercial – Pub	3500	770	Per 1000 sf leasable
Fitness Centre	490	105	Per 1000 sf leasable

3. Fire

Required fire flows shall be in accordance with the "Water Supply for Public Fire Protection - A Guide to Recommended Practice" as published by Public Fire Protection Survey Services, but in no case shall be less than 4.55 m³/min (1000 igpm) for 90 minutes unless approved in writing by the Regional District.

2.2 Water Pressure

Minimum design distribution pressure in all areas at peak demand shall be 276 kPa (40 psi) at the property line. The design engineer shall indicate any building sites where the pressure at the main floor of the building is expected to be less than 207 kPa (30 psi). The developer is expected to file covenants of low pressure on properties where the pressure at the main floor of the building is expected to be less than 207 kPa. With the combination of maximum daily demand and the specified fire flow, the minimum residual water pressure at the fire hydrant shall be 138 kPa (20 psi), and at the highest point in the system shall not fall below 69 kPa (10 psi). Where these minimum design pressures cannot be maintained due to an increase in elevation or distance from the point of connection, a booster pump station and emergency storage shall be provided as part of the distribution system.

The maximum allowable distribution line pressure is 900 kPa (130.5 psi) except where individual connections are permitted directly from trunk mains and where special precautions are taken. Otherwise, where distribution pressures will exceed 900 kPa due to a drop in elevation, a pressure reducing station shall be installed as part of the distribution system. Where distribution pressures exceed 550 kPa (80 psi), occupants in the area shall be required to install individual pressure reducing valves. This valve shall be of an approved design and manufacture.

2.3 Design Population

Design populations used in calculating water demand for residential properties shall be computed in accordance with the population predictions based on the total number of residential units and persons per unit (ppu) as determined by the Regional District from census data or with the persons/hectare (in 2011 an average single family detached home has 2.2 ppu*) :

Multiple dwelling unit development	125 persons/hectare
Dwelling unit	30 persons/hectare (12.5 homes/hectare)

Exceptions to these design population densities may be varied by the Regional District of Nanaimo with Board Approval.

2.4 Hydraulic Network

Depending on the complexity and extent of the proposed distribution system, the Regional District may require a hydraulic network analysis showing maximum design flows and minimum design pressures. If this information is required, it will be stated by the RDN in writing at the time of the **Feasibility Review** and shall be submitted by the applicant with the detailed design application. The hydraulic network shall be designed to provide the maximum design flows at or above the minimum required pressures specified in this Standard.

2.5 Water Quality

1. Water supplied to domestic consumers shall be of a quality meeting the guidelines for microbiological, chemical, and physical parameters listed in the “latest edition” of the Guidelines for Canadian Drinking Water Quality prepared by the Federal-Provincial-Territorial Subcommittee on Drinking Water. All new water source quality shall have parameters equal to or less than the aesthetic objectives (AO) listed in these guidelines. If necessary, treatment of the source water to reduce iron and manganese below AO shall be provided. Exceptions to these parameters may be approved in writing by the Regional District of Nanaimo with Board Approval.
2. All surface water supplies shall be suitably treated and disinfected as per provincial requirements/regulations. Disinfection will normally be solely by chlorination using proportional solution feed, but other approved methods will be considered, including ultraviolet (UV) units, provided residual chlorination is included.
3. Groundwater sources may require chlorination, either at the discretion of the Vancouver Island Health Authority (VIHA), or by the RDN to suit operational requirements such as integrating a new source into an existing chlorinated system. Space shall, as a minimum, be provided for all chlorine storage and associated equipment.

2.6 Supply Sources

1. Groundwater Source

Where groundwater is to be the source of supply, a copy of the well driller's log shall be submitted, together with a copy of a well completion report by a Design Professional or a professional geoscientist registered in the Province of British Columbia (The Design Professional). All new wells shall be constructed in accordance with the Groundwater Protection Regulations, November 1, 2005, or their most recent amendment or replacement legislation.

Wells shall be cased with a minimum 200 mm (8 inch) diameter steel casing having a minimum stickup of 300 mm (12 inches) above the proposed final ground surface. The well shall be completed with stainless steel screen(s) selected following sieve analysis of aquifer material, and shall have a surface casing of a minimum 250 mm (10 inch) diameter surrounding the 200 mm well casing (unless otherwise approved in writing by the RDN). The length of the surface casing shall be designed by The Design Professional and shall not be less than 3 meters (10 feet). A surface seal of at least 4.5 meters (15 feet) shall be installed as per the standard contained in the BC Ground Water Protection Regulation. The ground surface around the well head shall be graded to slope away from the well head at 2% grade or greater.

Any wells which encounter bedrock and source water from within rock, shall have well casing driven into the rock to establish a seal and have a surface annular seal placed to the depth at which bedrock is encountered or to a minimum depth of 4.5 meters (15

feet), whichever is less. All wells completed in bedrock must be equipped with PVC liner with threaded joints to allow for removal of the PVC for periodic well maintenance.

Modifications to well casing to allow for shallow subsurface connection, i.e., pitless adapter units, will require that the surface annular seal be re-established. All new wells shall be equipped with a 25 mm (1 inch) diameter PVC monitoring tube for the installation of a standard water level measuring device without danger of being stuck in the well.

The new well shall have a Well Identification Plate as issued by the BC Ministry of Environment attached to the well casing exposed at surface and clearly visible. Copies of all information for the well including the drillers log, pumping test data, analysis and written reports shall be submitted to the BC Ministry of Environment, VIHA and RDN.

The well completion report shall record results of well pumping tests which shall only occur during the late summer or early fall (August, September, October as this time is generally the lowest ground water levels of the year), and contain conclusions as to the capability of the source with the standard MOE 30%percent drawdown safety factor under conditions of zero surface recharge for 120 days (this figure may be reduced 100 days if authorized in writing by the RDN). All interference effects from adjacent constructed wells, on the assumption that they are all fully operational on a continuous basis over the same 120 day period, shall be allowed for in addition to the 30% drawdown safety factor.

No safety factor is required to be added to the interference drawdown allowance although a 15% reduction will be applied as per RDN Board resolution (December 2009) regarding well capacity redundancy and this will be reviewed by the RDN. The Design Professional shall recommend a rated pumping capacity for the well and all wells which will be reviewed by the RDN. The hydrogeologist may require specific pump rates for proper testing.

The Design Professional shall also assess if and what interference effects the new well will have on any adjacent operating RDN system wells. He shall provide an assessment of the effect in total litres per second of capacity reduction which those operating wells are anticipated to have over the 120 day zero surface recharge condition with the new well operating. The new well pump will be required to be sized to the full long term design capacity, but the allowable new supply applicable to support new development will be lowered by any such capacity reduction which it may have on operating RDN wells.

The well pumping test shall be run for 48 hours continuous pumping (72 hours in bedrock wells) at a pumping rate at or above the projected long-term pumping capacity of the well or until the water level stabilizes, whichever is the longest time. Adjacent constructed wells shall be monitored during the test pumping period, to allow The Design Professional to assess interference effects. Well recovery measurements shall also be carried out immediately on completion of the test pumping period and shall continue until the well has recovered to at least 95% of its initial level (the RDN may reduce this recovery to 80% but this must be authorized in writing by the RDN). A minimum long-term well design capacity rating of 3.8 l/s (50 igpm) is required for any individual well. The minimum standards for pumping test and well capacity can only be altered in writing by the RDN, where under special circumstances wells meeting all quality guidelines and a capacity rating between 2.3 l/s and 3.8 l/s may be considered by the RDN for acceptance. Well testing procedures shall be in accordance with information provided by the BC Government. In no case shall the pumping test be of

less time than it takes to produce a relatively stable water level in the well for an adequate period of time, as approved by The Design Professional.

The well completion report shall include a water balance for the aquifer, which accounts for seasonal recharge and withdrawals by users both directly up-gradient and down-gradient of the existing and proposed subdivision lots. All assumptions incorporated into the water balance calculations shall be stated in the report. The well completion report shall also include an assessment of any risk of flooding around the well and indicate what measures have been taken or will be taken to protect the well or wellhead from entry of flood debris or flood waters or physical damage due to flood debris, ice or erosion. Flood proofing shall be in accordance with the Drinking Water Protection regulation, Section 14 and the Ground Water Protection Regulation, Section 11.

The Regional District may require a more extensive quantitative and qualitative report by the Design Professional where unusual conditions or results occur. Further, the RDN may require the information provided by The Design Professional to be reviewed/scrutinized by a third party Design Professional appointed/retained by the RDN and paid for by the developer/well provider.

All new sources of water shall be approved by the Vancouver Island Health Authority (VIHA) and a “source approval” must be issued by VIHA prior to the source being connected to the Regional District of Nanaimo’s public water system. VIHA must also approve the well for service in writing. The connection of new properties requiring a new approved source of water shall not be permitted/approved by the RDN until the source is approved by VIHA. A wellhead protection (WHPR) report suitable to the RDN and in the format shown as “Minimum Requirements” shall also be submitted along with the information provided for source approval. Any requirements imposed by VIHA in the source approval shall be completed by the Developer, unless agreed to otherwise in writing by the RDN.

The RDN shall have legal control over a sanitary control area extending from the well head to a radius of 30 to 60 metres based on a wellhead protection report and to the satisfaction of both VIHA and RDN. RDN shall own the property as fee simple around the well head. The sanitary setback areas preferred form of legal control is fee simple ownership, particularly for the first 30 metres, however, if and to the extent that such is not feasible, this may also take the form of a sanitary control easement satisfactory to both VIHA and the RDN.

New sources shall also include provision of a suitable monitoring well that shall be designed and placed near the production well as recommended and designed by the Design Professional. The monitoring well shall be suitably completed and secured at the surface with a Model Solonist Gold (or other model if approved in writing by the RDN) electronic data logger placed at a suitable depth in the monitoring well.

2. Surface Water Source

The proposed use of surface water as a potable water supply source shall be approved by the Board before being considered. Any surface water source shall meet all provincial government regulations and guidelines for siting, for licensing and for treatment etc.

3. Source Pump Stations and Controls

Due to the individual requirements for source pump stations, a standard detail drawing is not provided in these Community Water System Standards. Prior to completing the preliminary design, the design engineer shall request samples of typical recent acceptable source pump stations, and confirm conceptual design requirements. This will be further reviewed, and requirements confirmed by the RDN at the feasibility design review stage.

Wellhead piping shall consist (as a minimum) of a wye strainer, turbine flow meter, air release valves, check valve, gate valve to throttle flows to recommended output with pressure gauges upstream and downstream and mating flanges with adapter coupling to allow installation of an orifice plate to fine-tune pump output, and a 50 mm (2 inch) diameter valved outlet with 62 mm (2.5 inch) diameter fire hose adapter for flushing purposes. A hose bib shall be provided to permit periodic water sampling. The wellhead building or enclosure shall be designed such that future access to the well is available for pump removal or well redevelopment. This shall normally be achieved by installing a pitless adapter on top of the well, protected from vandalism by installation in a non-confined space concrete chamber with spring-assisted aluminum cover and locking lid. A Model Solonist Gold (or other model if approved in writing by the RDN) electronic data logger shall be installed in the well, with data recording equipment and software. Access to install a well-line into the well for periodic manual monitoring of static and pumping levels in the well shall also be provided. Flow recording instrumentation is required. Surface source piping shall be similar in general concept to wellhead piping, modified as agreed with the RDN and to suit the special site circumstances.

The source pump station building shall be designed to provide adequate heating and insulation, lighting and ventilation. The size of the building shall be discussed and determined at the time of the feasibility review. The building shall be of concrete and block work construction, with two isolated rooms, each having separate access doors. One room shall house mechanical piping and electrical controls, and the second room chlorine injection equipment and liquid chemical storage with built-in spill containment. In special circumstances only, the RDN may approve the use of enclosures in lieu of a building, due to site space or access agreement limitations.

Each pump shall have a variable frequency drive combination motor starter with a motor circuit protector, a "hand-off-auto" selector switch, a green "pump run" pilot light, a red "pump failed" pilot light and an elapsed time meter.

Motor starters for submersible well pumps shall be equipped with quick-trip overload relays. Low level draw-down protection shall be provided utilizing electrodes suspended in the well. Restart of the pump shall be automatic when the water level in the well has recovered sufficiently; however, a red alarm light on the control panel shall require manual reset.

If the system consists of more than one pump, supplied from the same service, the control circuits shall be subdivided into branch circuits in such a manner as not to shut down the entire system if one pump circuit develops a fault. Also, time delays shall be provided to permit staggered re-start of the pumps after a power failure.

The pump control panel shall have protection against single-phasing and a red pilot light which will stay on until manually reset after a power failure.

If the system consists of more than one pump, an automatic alternator or manual lead pump selector switch shall be provided.

A single-pole, double-throw (SPDT) contact shall be provided for remote alarm purposes, which will be activated in the event of pump failure, motor overload, and power failure of low well level. Connection of alarm signal outputs to the RDN answering service or alarm centre shall be provided. An external alarm light may also be required for some installations.

Signal cables for pump control shall be directly buried, either alongside connecting pipelines or in a separate trench, wherever feasible. Cable warning tape shall be installed in the trench over signal cables.

For well sources on new systems where very little water-use occurs during the initial operation period until sufficient new users are connected, the RDN may require installation of an approved automatic flushing device, to help in maintaining water quality.

Supervisory control and data acquisition (SCADA) shall be provided from all data outputs to a central location within the new system, normally at the source pump station. The RDN will be responsible for connection of local data to a centralized system, and for any offsite programming requirements which may be required to integrate the new system into the overall water systems SCADA system.

The RDN may require emergency power back-up on all new water sources. This will be determined at time of feasibility review by analyzing system vulnerability.

2.7 Storage

1. Sizing

a) Reservoirs shall be sized to provide usable water storage volume to meet the fire flow requirements (Section 2.2.1.3) plus 20 percent of a maximum day's demand for the tributary area, and shall be of at least 365 cu. m (80,000 imperial gallons) capacity. The RDN may agree in writing to reduce the reservoir minimum size requirement.

2. Design

The materials and designs used for finished water storage structures shall provide stability and durability as well as protect the quality of the stored water. Unless one or more reservoirs in the same or higher pressure zone within the system are already operational, the reservoir is to be constructed with two independent cells. This is to allow maintenance of one cell to occur, while the second cell remains in service. During the feasibility review, the reservoir design, security features, dimensions, layout and material of construction shall be discussed and agreed with the RDN. Where practical, concrete reservoirs are preferred (although other materials of construction will be considered for acceptance) provided they are designed in accordance with the Building Regulations of British Columbia and amendments thereto. When topography and pressure zone conditions allow, an in-ground reservoir with a minimum 500 mm gravel and soil covering is preferred, for improved seasonal water quality. Steel structures shall also follow the current AWWA Standards concerning steel tanks, standpipes, reservoirs, and elevated tanks wherever they are applicable.

The foundation may be designed either with the bottom at ground level, bearing on a slab or ring beam or on legs with the bottom in an elevated position.

Foundation design shall be in accordance with Building Regulations of British Columbia and amendments thereto. A foundation or soils investigations report shall be submitted, prepared by a Geotechnical Engineer registered in the Province of British Columbia.

In addition to the seismic requirements of the Building Regulations of British Columbia due account shall be taken of the effects of both convective and impulsive forces generated by ground motion. Sufficient clearance shall also be provided between high water level and roof soffit to allow for wave generation.

The reservoir structure shall be designed to safely withstand all construction and operating loads.

Reservoirs shall be totally enclosed with adequate ventilation, screened and weather protected. Vents shall project above the highest anticipated depth of snow on the roof.

Concrete reservoirs shall be provided with a roof access hatch served by internal and external ladders. Steel reservoirs shall be provided with a roof access hatch served by internal and external ladders and low level access manhole. Roof access hatches shall be of aluminum with spring-assisted opening, and shall be lockable. A roof mounted plate shall be installed alongside the roof access hatch, to suit mounting of the RDN mobile safety winch mechanism, used during internal access operations.

Access ladders, safety cages, and platforms shall comply with the requirements of the Worker's Compensation Board. Chain link and barbed wire fencing of the reservoir site will be required by the RDN, unless otherwise approved in writing by the RDN for specific site location and security conditions.

An altitude gauge shall be provided at an elevation of 1.2 m above the reservoir foundation.

Inlet piping is to discharge into the reservoir above TWL elevation. An approved outlet set 100 mm above the reservoir floor, a valved drain set at floor level, and an overflow pipe with bell-mouth entry set at 200 mm above normal reservoir top water level with 300 mm clearance from underside of roof shall be provided.

Alarms requiring manual reset shall be provided to indicate reservoir high or low level. In a water system consisting of well or booster pumps, these alarms shall be transmitted along buried signal cables to a central location. Controls may utilize probes or transmitters. Where the reservoir is supplied via pumped water, pump start-stop controls will be required. The RDN may require individual start-stop levels for each pump, or staggered pump start-stop on a timer basis.

The Regional District will require the installation of flow meters with flow data transmission and recording from the reservoir outlet. Level monitoring and recording from a level transducer at the reservoir base, or in a chamber immediately on the outlet pipe, shall also be provided.

2.8 Water Distribution Piping

1. Materials

Unless otherwise permitted, the following pipe materials shall be used for water distribution:

Material	Specifications
Steel Pipe	AWWA C200
Ductile Iron Pipe	AWWA C151
PVC Pipe	AWWA C900 - Class 150, DR 18 maximum

All pipe shall be delivered to site with end caps for shipping and storage. Steel pipe shall be coated and lined in accordance with AWWA C203. Ductile iron pipe shall be cement mortar lined in accordance with AWWA C104. Joints shall be rubber gasket in accordance with AWWA C111. Where corrosive soil conditions exist and metal pipe materials are proposed for use, a soil corrosion survey shall be undertaken by an approved professional. The Regional District may require special protection for the pipe. All pipes shall be designed for the maximum pressures and earth loading to which the pipe will be exposed, but in no case shall the design working plus safety factor pressure or class be less than that providing an AWWA standard rating of 1030 kPa (150 psi). Lesser pressure class pipe may only be used when specifically approved otherwise by the RDN for large installations, where no possibility of pressure surges or pressure zone changes occurring, in which cases Class 100 or better rating pipe would be considered.

2. General Layout

Numerous trunk lines and secondary feeders shall be installed throughout the system. These mains must be large enough to deliver consumption and fire flow demands for the district served, and shall be spaced not more than 900 m apart and looped.

Minor distributors and pipes of the gridiron system shall be a minimum of 150 mm in diameter in residential districts with 150 mm diameter cross mains at intervals not exceeding 180 m. Where no longer lengths of pipe are necessary, 200 mm diameter or larger intersecting main shall be used unless initial pressures are unusually high. 200 mm diameter pipe shall be used where dead ends or poor gridironing are likely to exist for a considerable period, or where the layout of the streets and the topography are not adapted to the above arrangement. Lines furnishing domestic supply only, and not serving hydrants, may be 100 mm diameter. Mains in cul-de-sacs shall be looped wherever feasible by connecting through specifically created rights-of-way or parkland, or by twinning pipe installation and looping pipe ends, for improved water quality. Where a water main ends in a dead end, or a valve is normally closed, a fire hydrant or below ground flushout shall be provided for flushing purposes. Temporary above ground flushouts may only be used on those mains intended to be extended in the near future.

In the high value districts, the minimum size shall be 200 mm diameter. Pipe of minimum 250 mm or 300 mm diameter is to be used on major and network highways and roads as identified in the Official Community Plans of the Regional District and for long lines not cross-connected.

2.9 Service Connections

Unless otherwise permitted, only the following materials may be used for service connections:

Material	Specifications
Polyethylene, PE 3406 - N	Potable Series 160 B.137.1
Plastic	ASTM D2666
Soft Copper, Type K	ASTM B88

In general, polyethylene shall be used for new services, except in special approved circumstances, and copper for replacement of existing old service piping by trenchless “pipe splitting” methods.

The minimum size of service connection is 19 mm diameter. Where the length of service between the main and anticipated building frontage exceeds 30 m, the service connection shall be minimum 25 mm diameter. Corporation and curb stops shall be of the same diameter as the service piping. In the larger sizes of service connection piping, the materials specified in Section 2.8 for water distribution may also be used.

Drawing W-7 of this Schedule shows the general arrangement for water service connections. The minimum size of service connection is 20 mm diameter.

Water service connection locations shall be co-ordinated with B.C. Hydro, TELUS (Telephone Company), and Shaw Cablesystems to avoid any conflict with poles (or proposed underground facilities and service conduits for underground utility installations) at the property lines of parcels. Similarly, conflict with Terasen (gas) services shall also be reviewed and avoided.

1. Corporation Stops

Corporation stops shall be in accordance the following supplementary data:

- a) Full port ball valve.
- b) Minimum 150 psi rating.
- c) AWWA x compression.
- d) Compression nut machined to bottom out on valve body shoulder.
- e) Saddle clamps shall be used as specified by the manufacturer.

2. Curb Stops

Curb stops shall be in accordance with the following supplementary data:

- a) Full port ball valve.
- b) Minimum 150 psi rating.
- c) Compression x meter swivel nut.
- d) Compression nut machined to bottom out on valve body shoulder.
- e) Integral locking.
- f) Drain holes not permitted.
- g) Set on main side of meter box to facilitate meter installation when required.
- h) Curb stops shall initially be set in a 100 mm diameter PVC riser pipe, with the meter box to be installed by the RDN on final connection when the building is under construction, unless agreed otherwise. Concrete meter boxes with full support lip

and steel lid drilled for touch-read meter pad shall be provided to the RDN for this purpose.

2.10 Fire Hydrants

Hydrants shall be in accordance with AWWA C502, compression type, factory-painted yellow. The minimum hydrant size shall be 150 mm diameter. The minimum depth of bury shall be 1.2 m. There shall be a minimum of two 65 mm house outlets and one pumper outlet 117.5 mm P4.23, outside diameter male outlet complete with caps per hydrant. One of the outlets shall have an independent shut-off. Opening for both the main hydrant valve and independent shut-off shall be to the left (counter-clockwise). Outlet threads shall conform to the British Columbia Fire Hose Thread Specification. Main valve spindle and outlet nuts shall be standard pentagon shape. Main valve spindle: pentagon in 45 mm circle. Independent spindle: square 16 mm x 16 mm. Drain outlets are to be provided.

Drawings W-12 and W-13 of this Schedule show the general arrangement for the installation of hydrants. Connections shall not be less than 150 mm diameter. A gate valve will be provided on all connections between the hydrant and the main. Installations shall be in general accordance with AWWA M17. The hydrant shall be installed vertical, with the pumper nozzle perpendicular to the priority access road centreline. Mechanical joint thrust restrainers shall be used on all leads up to 6 m length. For longer hydrant leads, approved joint restrainers shall be used at each pipe joint, or alternatively a thrust block shall be installed behind the hydrant 'boot' in accordance with Drawing W-9.

Hydrant distribution shall be in general conformance with the aforementioned Standard of Municipal Fire Protection, but in all cases spacing shall be such that the maximum distance from a hydrant to the centre of any property measured along the centreline of the street and at right-angles to the property is 75 m. Hydrants will be set in 6 m from the corner at any intersection to facilitate future widening or other street works.

2.11 Valves

Unless otherwise permitted, only the following valves shall be installed in the distribution system:

1. Gate Valves

Gate valves shall be in accordance with Drawing W-8, AWWA C500 and the following supplementary data:

- a) Gate valves shall have an iron body, brass mounted.
- b) Valves shall be the same size as the pipe in which they are installed, up to and including 300 mm diameter. In mains over 300 mm diameter, valves may be butterfly type.
- c) Valve ends shall be provided to fit the pipe.
- d) The position of the in line valve shall be vertical.
- e) Stem seals shall be O-ring.
- f) Valves shall open to the left (counter-clockwise).
- g) Gears will be required on valves 400 mm and larger. Gear cases shall be totally enclosed.
- h) Bypasses will be provided on valves 500 mm in diameter and larger.
- i) Valves shall have a 50 mm square operating nut.

2. Rubber Seated Butterfly Valves

Rubber seated butterfly valves shall be in accordance with AWWA C504 and the following specifications:

- a) Valves shall be the same size as the pipe in which they are installed. Valves shall be of wafer style or short body flanged.
- b) Valve ends shall suit the pipe.
- c) Maximum nonshock shutoff pressure shall be suitable for 1030 kPa, bubble tight.
- d) Valves shall be designed for the extreme maximum flows for both opening and closing.
- e) Shaft seals shall be O-ring type.
- f) Valve disks shall be ductile iron.
- g) Valve operators shall be suitable for buried installation and equipped with a standard operating unit.
- h) Valves shall open to the left (counter-clockwise).
- i) Operators are to be located on the side of the valve with the operating spindle in the vertical position.

In general, valves shall be located at intersections and shall be so positioned that no more than 150 m for high value district and 250 m for other areas are isolated in the case of line repairs. In larger trunk and feeder mains where no interconnections are made, the spacing of valves should not exceed 500 m.

Approved joint restraint fittings shall be provided on all valves.

Where valves are located in the roadway, valve boxes shall be Nelson Type of cast iron and telescoping so the surface loads are not transmitted to the valve body of pipeline. A minimum of 200 mm of future adjustment shall be available on all valve boxes for future raising of grade, by locating the top of PVC riser a maximum of 100 mm below the completed asphalt apron grade at the time of initial installation. Cast iron hoods shall be provided on all gate valves 250 mm diameter or larger. In areas where there is no traffic, valve boxes may be as approved by the Regional District.

Valve markers shall be installed to indicate the location of all valves. These markers shall be constructed of 50 mm metal pipe painted sky blue and set in a concrete base. They shall extend 1 m above the ground surface. The markers shall be located 2 m from the property line opposite the valve and the distance to the valve is to be marked in black figures on a flattened upper portion of the marker.

2.12 Fittings

Fittings shall be designed for a minimum of 1030 kPa working pressure and shall be in accordance with AWWA C110. Ends shall be flanged or belled to suit pipe ends. Flanges shall conform in dimension and drilling to ASA B16.1, Class 125. Flange gaskets shall be of natural rubber and shall be 3mm thick with a layer of cotton on both sides. Approved joint restraints shall be used at all fittings, including restraining of a suitable length of pipe each side of the fitting, except at fire hydrant leads over 6 m with unrestrained pipe joints and at main dead-ends, where thrust blocks shall be provided as shown on Drawing W-9 of this Schedule. Thrust calculations for joint restraints shall be carried out in accordance with the manufacturer's specifications, and shown on the design drawings. Length of pipe to be restrained at each fitting shall be clearly shown on each applicable plan drawing, for the varying pipe sizes and fitting configuration.

2.13 Trenching and Backfill

The standard trench section is shown in Drawings W-1, W-2, and W-3 of this Schedule for various conditions. The nominal minimum depth of cover shall be 1.2 m but in no case shall it be less than 1.0 m unless otherwise permitted by the Regional District. Water mains shall be located not less than 3 m centre-to-centre from all sanitary and storm sewer lines, unless otherwise permitted by the Regional District and the Vancouver Island Health Authority.

1. Bedding material shall conform to the following gradation limits:

Gradation Limits
(Percent by Weight Passing)

Sieve <u>Designation</u>	<u>Type 1</u>	<u>Type 2</u>
19.0 mm	100	90-100
12.5 mm		65-85
9.5 mm	85-100	50-75
4.750 mm	70-100	25-50
2.36 mm		10-35
1.18 mm	20-65	
0.850 mm		5-20
0.6 mm	0-45	
0.425 mm		0-15
0.18 mm		0-8
0.15 mm	0-10	
0.075 mm	0-5	0-5

2. Type 1 is the standard acceptable bedding material. Type 2 shall be used where specified by the design engineer to meet special design loading. Dry sieve analysis shall be carried out in checking material gradation.
3. Other acceptable bedding materials, for use only where shown on the construction drawings or as approved by the Engineer, are drain rock, pea gravel or native material. In rock, pipe zone shall have filter fabric between rock and bedding material. Filter fabric shall be non-woven, minimum grade Armtex 200 or equivalent.
4. The bedding material shall cover the full width of the trench bottom and have a minimum depth of 100 mm on completion of compaction. In rock excavation the minimum depth of bedding below the pipe shall be 150 mm after completion of compaction.

5. Bedding material shall be compacted in maximum 150 mm lifts to 95% of Modified Proctor Density (ASTM D1557). Side tamping shall be carried out with bedding material placed to the pipe springline, to provide haunch support.
6. Bedding material shall be placed in such a manner that the pipe is evenly supported throughout its length by the pipe bedding material.
7. Placement and compaction of the bedding material shall not damage or displace the pipe.
8. Bedding material shall be leveled across the full width of the trench to an elevation of 300 mm above the crown of the pipe.

2.14 Pressure Reducing Stations

General requirements for pressure reducing stations shall be as follows:

1. A valved bypass shall be provided.
2. A surge relief valve shall be provided to release pressure in the event of a failure of the pressure reducing valve(s). The surge relief valve may be incorporated into the pressure reducing station or may be located at some other suitable location within the distribution system.
3. Pressure reducing valves shall be sized to provide adequate pressure control through all ranges of design flows. If necessary, two or more pressure reducing valves of varying sizes will be provided in the one station.
4. Each pressure reducing and surge relief valve will be provided with isolating valves and be installed so that individual components may be easily removed for repair or replacement.
5. The whole of the pressure reducing stations shall be enclosed in a reinforced concrete vault with a standard manhole cover and other opening large enough to remove the largest single piece of equipment in the station. Floor drains sloped at 2 percent shall be provided to keep the station dry at all times and shall not be directly connected to any sanitary sewer, or to a storm sewer without a backwater valve in the storm service connection. Drains to the surface are permissible if there is no risk of flooding. Otherwise, underground absorption pits or sump pumps will be required depending on site condition. A permanent access ladder shall be installed.
6. Pressure gauges complete with snubbers shall be installed to register both upstream and downstream pressure.
7. Adequate strainers with dual cartridge filters shall be supplied on the water used for controlling and regulating valves.

2.15 Booster Pump Stations

General requirements for booster pump stations shall be as follows:

1. A valved bypass shall be provided.
2. There shall be sufficient capacity so that, with the most important pump out of service, the station will be capable of supplying the maximum design flow.
3. It may be requested that provision be made to provide the maximum design flow during a power failure. Normally this will be accomplished by means of an elevated storage tank. Where this is not possible, emergency standby internal combustion engines shall be installed either for direct drive or electric generation.
4. Where design flows are such that starting and stopping surges will cause water hammer in the inlet or discharge lines, pump control valves or other pressure control devices shall be provided. Relief valves will also be required to protect against surges caused by power failure.
5. Pumps shall be controlled by automatic devices satisfactory to the Regional District. Flow and pressure measurement shall be provided where required. Flow recording may be required for some installations. Signal cable for pump control shall be directly buried, either alongside connecting pipelines or in a separate trench, wherever feasible. Cable warning tape shall be installed in the trench over signal cables.
6. Pumps shall normally be housed in above ground buildings, designed to provide adequate insulation, heating, lighting and ventilation.
7. Each pump shall have a combination motor starter with a motor circuit protector, a "hand-off-auto" selector switch, a green "pump run" pilot light, a red "pump failed" pilot light and an elapsed time meter.

If the system consists of more than one pump, supplied from the same service, the control circuits shall be subdivided into branch circuits in such a manner as not to shut down the entire system if one pump circuit develops a fault. Time delays shall be provided to permit staggered re-start of the pumps after a power failure.

The pump control panel shall have protection against single-phasing and a red pilot light which will stay on until manually reset after a power failure.

If the system consists of more than one pump, an automatic alternator or a manual lead pump selector switch shall be provided. Time delays or other means suitable to prevent hunting on momentary pressure surges shall be provided.

The pumps shall be shut down and stay locked in the event of motor high temperature or motor overload. The pumps shall also shut down on low suction pressure, however, re-start shall be automatic when the section pressure recovers, except that a red pilot light shall stay on until manually reset.

A single-pole, double-throw (SPDT) contact shall be provided for remote alarm purposes, which will be activated in the event of pump failure, motor high temperature, motor overload, low suction pressure, power failure or standby engine failure (if applicable). Connection of alarm signal outputs to the RDN answering service or alarm

centre shall be provided. An external alarm light may also be required for some installations.

2.16 Water Meter Chambers

General requirements for meter chambers on services of 37 mm diameter and larger shall be as follows:

1. An approved meter and double check backflow preventer shall be provided. The meter shall be touch-read style, conforming to the standard meter manufacturer and reading system used by the RDN.
2. Meters shall be sized to meet the anticipated maximum demand required, while providing accurate metering throughout the flow range. Compound meters, or large and small meters installed in parallel, may be required to meet these requirements, particularly where fire flows are to be metered. Pressure loss and maximum velocities shall also be examined. For systems supporting in-building wet fire sprinkler systems, available pressures during flow conditions shall be examined, to ensure adequate operating pressure is maintained at the sprinkler heads.
3. The meter shall be installed in a chamber or chambers, which are of non-confined space access design. Large lids shall be spring-assisted opening, suitable to carry traffic loading unless the location is totally isolated from existing or future traffic, of aluminum construction when feasible.
4. If a sidewalk location is unavoidable for the meter chamber, the box shall be situated to maximize the unobstructed walking corridor.
5. The meter shall be installed in a horizontal plane.
6. A valved by-pass shall be provided for meters 50 mm diameter and larger, to avoid service shutdown during meter maintenance. For combination domestic and fire flow meters, the by-pass shall be sized for the largest flow rate. By-pass and isolation valves may be installed external to the meter chamber.
7. Meter box lid shall be suitable for mounting a touch pit read pad.

3. CONSTRUCTION

3.1 General

1. Access Roads

Temporary roads shall be constructed as required for access to the working areas. Adequate drainage facilities in the form of ditches, culverts, or other conduits shall be installed as found necessary to maintain these roads. In the construction of access roads, existing drainage facilities, natural or otherwise, shall not be disturbed to the detriment of properties outside the working area and such facilities shall, unless otherwise provided elsewhere in the specifications, be restored to their original condition on completion of the work.

2. Sanitary Facilities

Clean, sanitary latrine accommodations shall be provided and shall be located and maintained in accordance with the regulations of VIHA.

3. Special Tools, Operating Manuals, Shop Drawings

With each piece of mechanical and electrical equipment or machinery having wearing parts and requiring periodical repair and adjustment, all special tools, wrenches, and accessories required for removing worn part, making adjustments, and carrying out maintenance shall be supplied. All gauges, indicators, and lubricating devices necessary for the proper operation of the equipment shall be furnished.

With each piece of equipment, four sets of operating manuals and as-constructed shop drawings shall be supplied. The manuals shall provide the manufacturer's recommended maintenance schedules with the grades of lubricants required, and instructions as to how the equipment may be taken apart for periodical inspection and replacement.

4. Blasting

Blasting will be permitted only after securing the approval of the applicable authorities. Blasting will not be carried out without first verifying that insurance covers any loss of life or damage that may result from this work. The Regional District, in granting approval for blasting, does not in any way assume responsibility for injury, loss of life, or damage that results there from, and such approval shall not be construed as approval of the methods employed in blasting, the sole responsibility therefore being that of the applicant.

5. Site Maintenance and Clean Up

The working area shall be maintained in an orderly manner and shall not be encumbered with equipment, materials, or debris.

Clean up shall be a continuing process from the start of the work to final acceptance of the project. Property on which work is in progress shall at all times be kept free from accumulations of waste materials or rubbish. Accumulations of waste materials, which might constitute a fire hazard, shall not be permitted. Spillage from hauling vehicles on traveled public or private roads shall be promptly cleaned up. On completion of construction, all temporary structures, rubbish, and waste materials resulting from the operations, shall be removed.

6. Erosion and Sediment Control

An Erosion and Sediment Control Plan shall be submitted for review and approval seven days prior to the pre-construction meeting. The Erosion and Sediment Control Plan shall describe the proposed methodology to minimize potential impact on the surrounding environment. The Erosion and Sediment Control Plan shall indicate how the Contractor plans to control sediment discharges from the project and what measures will be put in place to prevent damage to aquatic habitat located downstream.

The work shall be carried out in compliance with the submitted and approved Erosion and Sediment Control Plan and all other environmental laws affecting the work and with the recommendations contained in the most recent edition of the "Land and Development Guidelines for the Protection of Aquatic Habitat" published jointly the Ministry of Environment and Fisheries and Oceans Canada.

For the erosion and sediment control plan, 'environmental laws' means all statutes, regulations, orders, and bylaws relating in any way to the natural environment or its ecosystems, public or occupational health, transportation, storage or handling of contaminants or hazardous materials.

3.2 Existing Structures and Utility Works

1. Scope

Existing structures shall be interpreted as being all existing pipes, ducts, ditches, or other works forming a part of sewerage, drainage, water, telephone, electrical, gas, or other utility system, as well as sidewalks, curbs, poles, fences, buildings, and other man-made things that may be encountered during construction.

2. Material Supply

Unless specified otherwise, materials supplied for replacement of existing structures shall be at least equal to those being replaced.

3. Location of Structures

Drawings or descriptions, verbal or otherwise, of existing structures or their location that are supplied by the Regional District are intended only as an aid to locating these structures. Measurements and location of the existing underground structures shown on the drawings are not guaranteed to be accurate, and must be verified prior to proceeding with construction.

4. Protection of Structures

Unless authorization from the Regional District is received for their removal, underground and surface structures encountered during construction shall be protected from damage. In the event of damage resulting from the construction operation, structures shall be repaired or replaced to a condition, which is at least the equivalent of that which existed prior to construction.

5. Emergency Situations

In emergency situations resulting from the construction operation, where life or property are endangered, the applicant shall immediately take whatever action is possible to eliminate the danger, and shall also notify the Regional District of the situation.

6. Access Maintained

Existing hydrants, valve or control pit covers, valve boxes, curb stop boxes, fire or police call boxes, and all other utility controls, warning systems, and appurtenances thereof shall not be constructed or made inaccessible at any time by the construction work. Bridges, walks, or other temporary facilities shall be provided as may be necessary to ensure that these controls or warning systems are free for use in their normal manner at all times during construction.

7. Curtailment of Utility Service

Where existing utilities such as water, sewer, electricity, telephone, and gas are serving the public, work shall be planned and executed such that there is no curtailment of service provided by these utilities without prior receipt of approval of the authorities responsible for provision and maintenance of these utilities. The applicant shall obtain the above approvals from the recognized authorities controlling these utilities. If approval for such disruption of utility service is not granted, it may be possible to establish temporary facilities to provide continuous utility service during the course of construction. Such temporary facilities shall only be implemented after receiving the approval of the utility authority.

If approval is received to temporarily shut off an existing utility, individual users of the utility shall be notified at least one hour prior to the time of shut-off.

If there is going to be a shut-off, the Fire Department shall be notified at least one hour prior to shut-off time.

8. Support of Structures

Existing structures shall be protected against damage from settlement by means of timber support or compaction of backfill as required. Where necessary, timber support shall remain in place following backfill of excavations.

Backfill which is placed under or adjacent to the existing structures, which have been undermined during excavation, shall be compacted in a manner which will prevent damage of the structure from settlement. Such backfill shall be of approved granular material suitable for compaction.

On existing piping, this material shall extend horizontally a minimum distance of 600 mm on both sides of the pipe at a level 300 mm above the pipe, and shall slope down from this point at 1-1/2 horizontal to 1 vertical to meet the bottom of the excavation.

9. Drainage Facilities

Existing culverts, enclosed drains, flumes and ditches, and other drainage structures affected by the work but left in place shall be kept clear of excavated material at all times during construction. When it is necessary to temporarily remove an existing drainage structure, suitable temporary ditches or other approved means of handling the drainage shall be provided during construction.

3.3 Clearing

Prior to clearing, the exact limits of the areas on which clearing may take place and whether or not there are restrictions placed on clearing which would result in leaving certain trees, structures, or other existing items in place shall be ascertained.

Prior to trenching, the right-of-way shall be cleared of all standing or fallen brush, timber, stumps, or other debris, which may obstruct the construction operation, damage the completed installation, or detract from the appearance of the site on completion of construction. This material shall be burned or otherwise disposed of to the satisfaction of the Regional District.

The restrictions of all authorities established to control burning in the area shall be complied with. If burning cannot be done on the clearing site, the material shall be hauled to an approved location for burning or disposal. Burning permits, as required, shall be obtained by the applicant.

3.4 Trench Alignment and Depth

Following clearing and prior to excavation of the trench, the location at which the pipe shall be installed shall be established by setting stakes at 20.0 m intervals along a line offset from the centre of the proposed pipeline.

Where pipe is to be installed to a predetermined grade, a cut sheet will be provided showing the depth of the pipe invert relative to the grade stake elevation at the respective locations along the pipeline.

The trench shall be excavated so that pipe can be laid to the established alignment and depth, with allowance made for specified trench wall clearances and bedding as shown in Drawings W-1, W-2, and W-3 of this Schedule for various conditions, or otherwise required.

All trenching and excavations shall be carried out in the manner recommended by the Workers' Compensation Board of British Columbia, or as may be necessary to protect life, property, and structures adjacent to the work and the work itself.

3.5 Pipe Installation

In general, and without limiting the clauses set out in this Standard, pipe shall be installed in accordance with the following specifications:

Ductile Iron Main	AWWA C600
Steel Mains	AWWA C603
PVC Mains	AWWA C900

3.6 Trench Backfill

Trench backfill shall be carried out as shown in Drawings W-1, W-2, and W-3 of this Schedule for various conditions.

3.7 Repairs

Any system approved and built to these standards which requires maintenance work, shall be repaired with materials and construction methods conforming to the specifications contained herein.

4. TESTING AND DISINFECTION

4.1 Written Reports

The applicant shall submit reports to the Regional District certified by a Design Professional of the tests and chlorination requirements specified herein.

4.2 Leakage Tests

Following final trench backfilling, leakage tests shall be performed on all installed piping.

Leakage tests shall be carried out between valved sections of the installation such that every valve in the system is tested for leakage in the shut-off position.

Leakage tests shall be performed in the following manner. The section to be tested shall be filled with water and all air expelled from the piping. It is recommended that the test section be filled with water for at least 24 hours prior to testing. By pumping water into the test section, the pressure within the piping shall be increased to 0.7 MPa, or 1-1/2 times the system operating pressure at the point of test, whichever is the greater. This pressure shall be maintained constantly in the pipe throughout the duration of the test by the addition of make-up water. The duration of the test section to maintain the specified pressure over the period of test shall be considered to be the leakage.

Piping will not be accepted until the leakage is less than the maximum allowable leakage determined from the following formula:

$$L = ND \times \text{the square root of } P$$

in which L = the allowable leakage in litres per hour,
N = the number of joints in the test section,
D = the nominal diameter of the pipe in millimetre, and
P = the average test pressure during the leakage test in megapascals.

Should any test disclose leakage greater than that specified above, the defect shall be located and repaired, and the section shall be retested to ensure that the leakage is within the allowable limits.

4.3 Flushing

The pipe shall be cleaned of dirt and other foreign materials. The pipe shall be flushed at water velocities of 1.0 m/s, or as high a velocity as can be obtained from the available water sources. Flushing water shall be discharged to watercourses or ditches that have sufficient capacity to carry the flow. Measures shall be taken to avoid any damage to fish habitat or to fish and other aquatic life.

4.4 Chlorination

On completion of the flushing operation, main pipes and services shall be chlorinated. Chlorination procedures shall conform to AWWA C651.

On completion of chlorination, the entire piping system shall be thoroughly flushed of all highly chlorinated water and filled with normal system water at a slow rate to avoid stirring deposits from existing mains, sampled in accordance with VIHA, and following satisfactory test results left in a condition ready for use.

Water reservoirs and storage tanks shall be disinfected in accordance with AWWA C652, and wells in accordance with AWWA C654.

Chlorinated water shall be disposed of in such a way as to not cause harm or damage to fish, vegetation or aquatic life in bodies of water or water courses; all federal and provincial regulations and/or guidelines on disposing of chlorinated water to the environment shall be followed.

4.5 Inspection

The Regional District shall be given 48 hour notice of all tests and chlorination.

5. TRANSFERRING THE WATER SYSTEM TO THE RDN

5.1 Final Inspection by RDN

Prior to requesting a Final Inspection, the Design Professional shall submit to the Regional District complete Record Documents, a completed Certification of Installed Works, all applicable test results (chlorination, pressure, leakage, health, commissioning, etc.), and Certificate of Approval for electrical works (pump stations, wells, lighting, controls, etc.) The Final Inspection shall be arranged by the Design Professional on completion of the work. This shall be directed by the Design Professional in the presence of approved representatives of the Regional District and the installation Contractor. A complete list of deficiencies identified during the final inspection shall be prepared by the Design Professional. Once the deficiencies have been satisfactorily rectified, the Design Professional shall so notify the Regional District. The date of the Final Inspection will generally be regarded as the commencement of the guarantee period, unless significant deficiencies critical to the effective operation of the system are found at the inspection, at the discretion of the Regional District.

5.2 Preparation/Execution of Transfer Agreement by Developer

The Developer shall prepare and execute a Draft Transfer Agreement for the works and submit the document to the Regional District for review/comment. Once approved by the Regional District the Developer shall complete the document and execute it accordingly and submit to the Regional District for them to execute. The date of the Transfer Agreement shall be the date on which the Regional District executes the document.

5.3 Preparation/Execution of Maintenance Agreement

The Developer shall prepare and execute a Draft Maintenance Agreement for the works and submit the document to the Regional District for review/comment. Once approved by the Regional District the Developer shall complete the document and execute it accordingly and submit to the Regional District for them to execute.

The Developer shall guarantee the workmanship and the performance of the work as per the Maintenance Agreement, from the date of acceptance (generally the date on which the Regional District executes the Transfer Agreement) for a period of two years. This shall be additionally secured by way of cash or an irrevocable letter of credit suitable to the Regional District in the amount of 10% of the cost of construction as certified by the Design Professional or \$10,000.00 (whichever is greater). There will be no interest paid on this security.

The RDN may reduce the length of the guarantee period and/or the amount of the security. The RDN may also require additional payment, or payout a credit as appropriate, related to an adjustment of the initial engineering fee to final construction cost values, in accordance with RDN Bylaw 1259.03 or most recent amendment. Any change to the guarantee period, security amount or the engineering fee is required to be in writing.

5.4 Preparation/Execution of Latecomer Agreement

Where a latecomer agreement may be applicable to a portion of the costs of the works, as agreed by the Regional District and any other applicable jurisdictions, the Developer shall pay all costs of both the Regional District and the Developer associated with the preparation, execution, and registration of the necessary Latecomer Agreement. The Regional District will assume any internal staff costs involved in planning, reviewing, approving, and administering the Latecomer Agreement preparation, and any administrative and financial costs involved during the effective time-period of the agreement. Based on current legislation, a Latecomer Agreement expires 10 years after its initial registration.

5.5 Letter of Acceptance of the Works by RDN

Following completion of all the foregoing requirements, the Regional District will issue the formal Letter of Acceptance of the Works.

The Regional District will also issue a written statement that the new works can be connected to the District's existing system. Such connection shall be undertaken by the applicant under the direct supervision of the District or by the District at a cost to the applicant.

**REGIONAL DISTRICT OF NANAIMO
BYLAW NO. 500**

**LAKES DISTRICT AND SCHOONER COVE
COMMUNITY WATER SYSTEM STANDARDS**

APPENDIX 1

STANDARD DRAWINGS

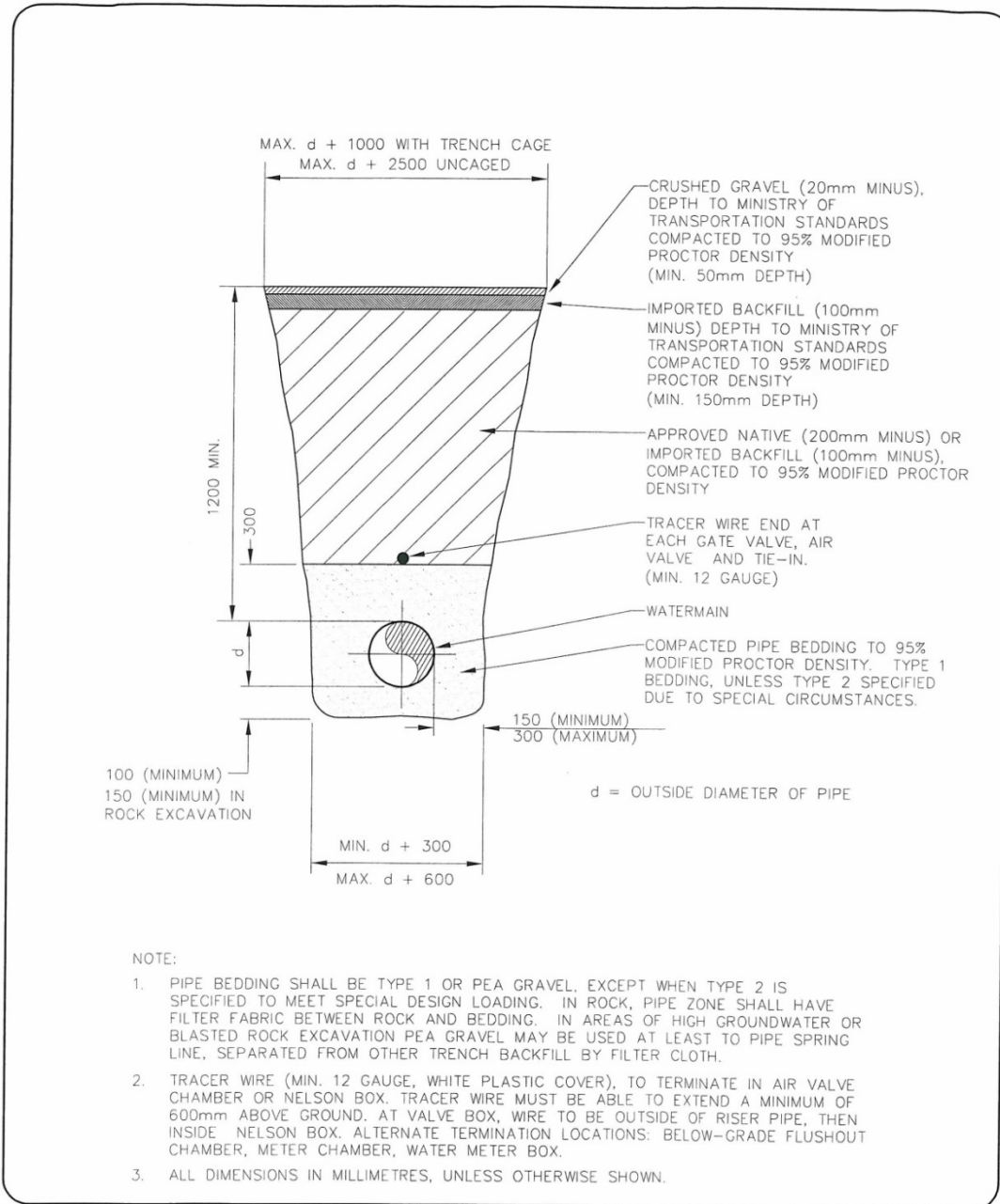

 **BYLAW No. 1562**
COMMUNITY WATER SYSTEM STANDARDS

TRENCH DETAIL
SHOULDER AREAS

REVISIONS		
No.	DATE	DETAILS
0	JUN/06	BYLAW UPDATE
		APP. W.F.M.

REVISION
0

DRAWING No.
W-1

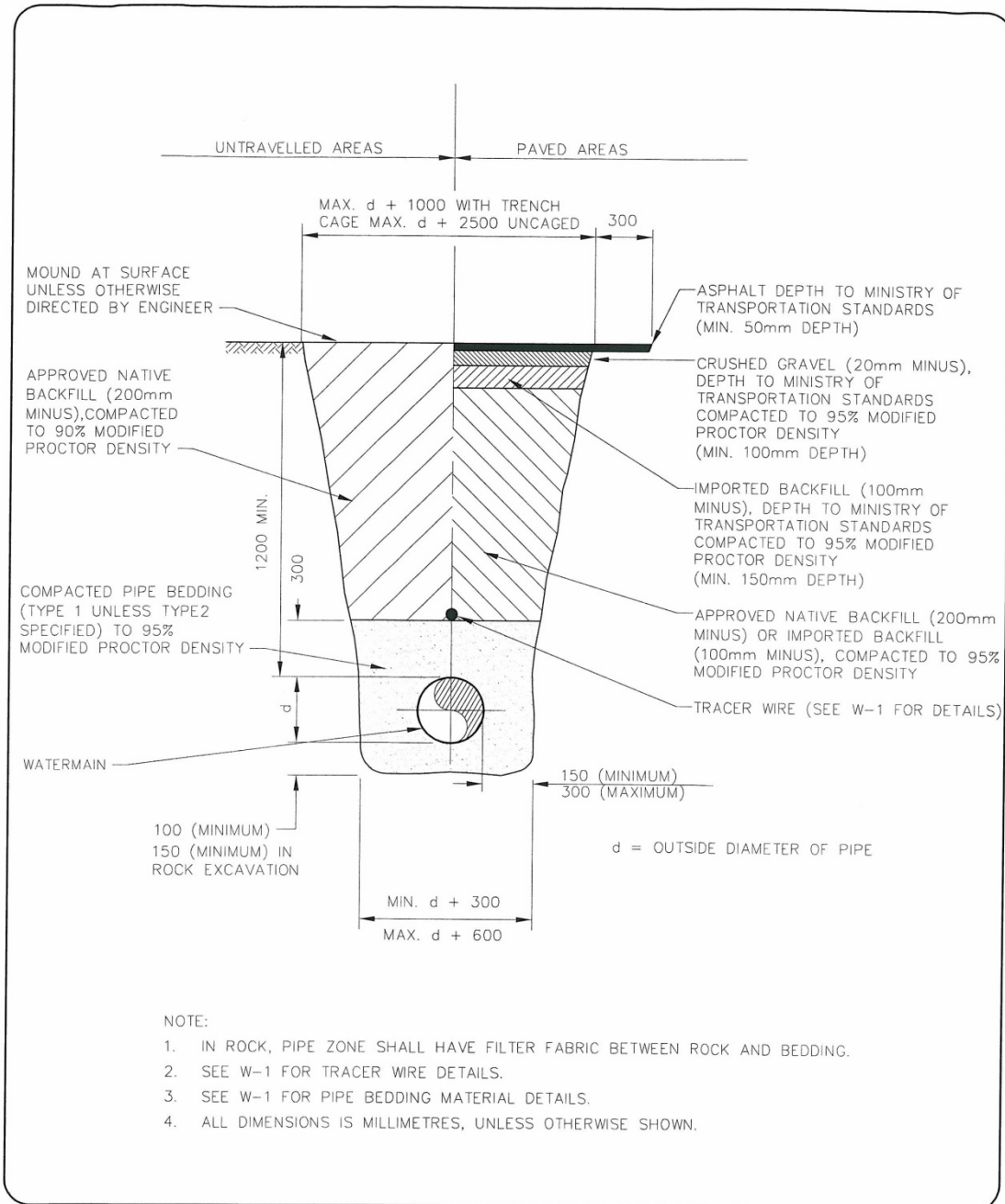



BYLAW No. 1562
COMMUNITY WATER SYSTEM STANDARDS

TRENCH DETAIL
PAVED & UNTRAVELLED AREAS

REVISIONS			APP.
No.	DATE	DETAILS	W.F.M.
0	JUN/06	BYLAW UPDATE	

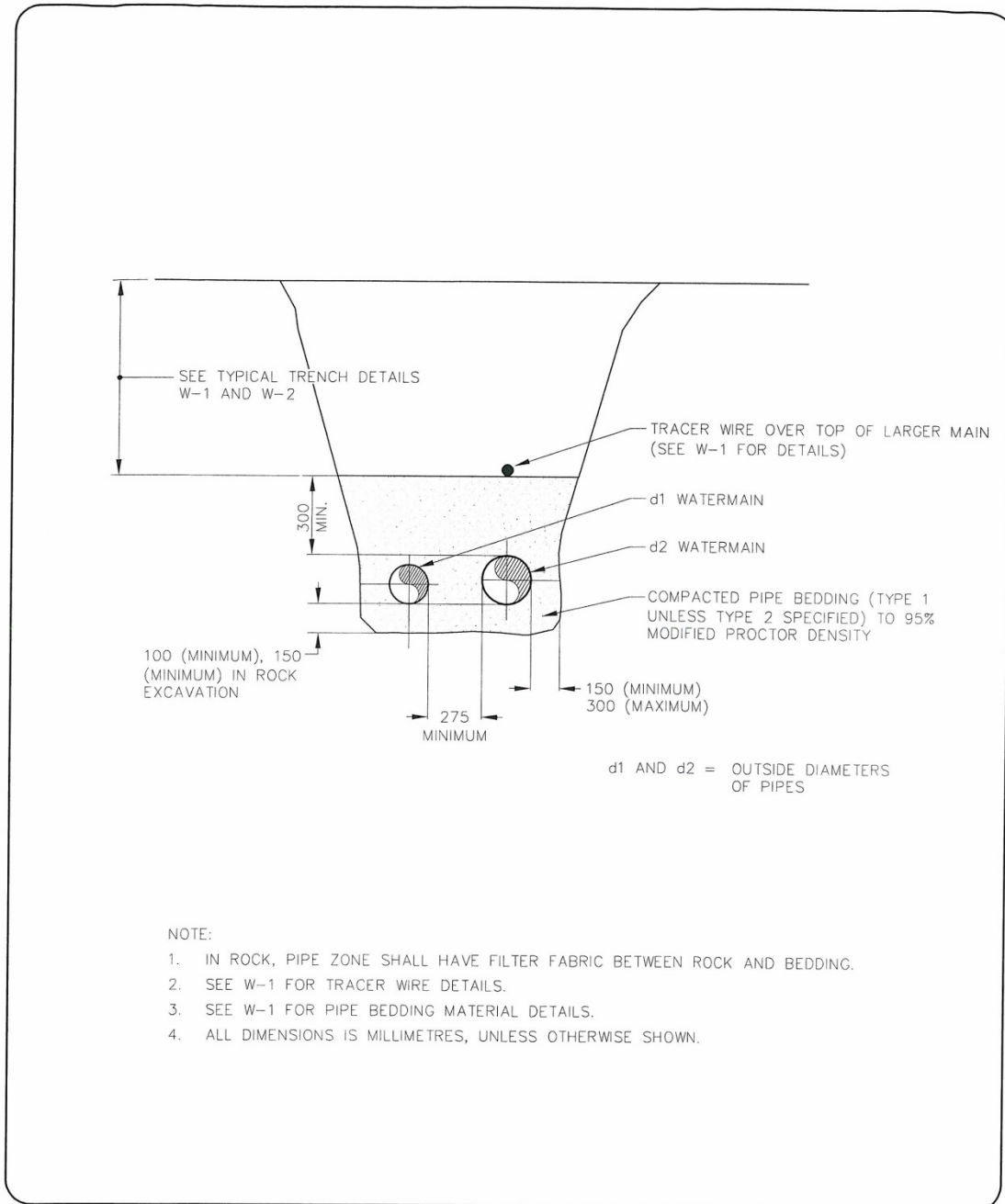
REVISION
0
DRAWING No.
W-2



REGIONAL DISTRICT OF NANAIMO

BYLAW No. 1562
COMMUNITY WATER SYSTEM STANDARDS

**TRENCH DETAIL
TWO PIPES**



REVISIONS			APP.
No.	DATE	DETAILS	
0	JUN/06	BYLAW UPDATE	W.F.M.

REVISION

0

DRAWING No.

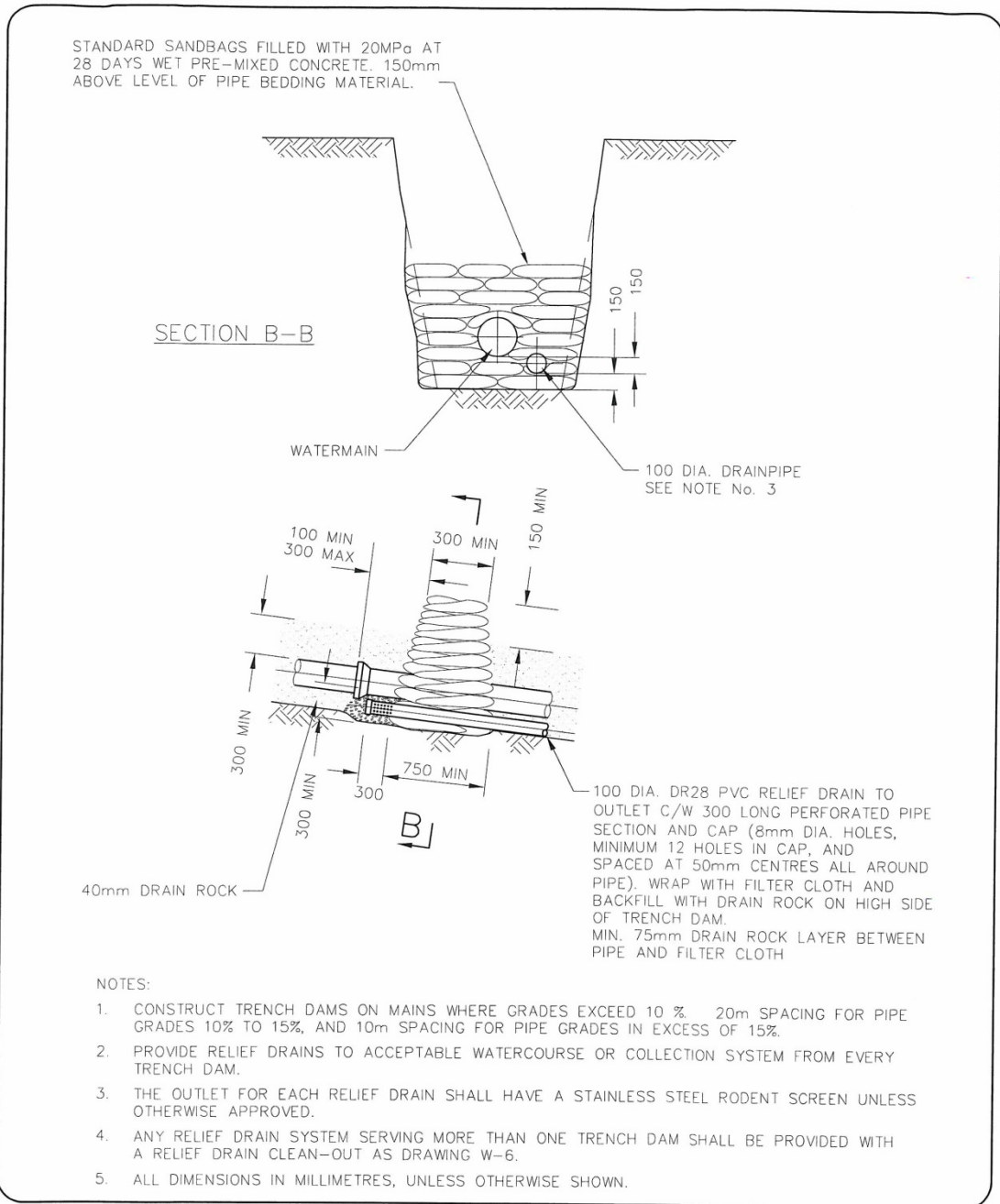
W-3

BYLAW No. 1562
COMMUNITY WATER SYSTEM STANDARDS

TRENCH DAM
SANDBAG CONCRETE TRENCH DAM

REVISIONS			
No.	DATE	DETAILS	APP.
0	JUN/06	BYLAW UPDATE	W.F.M.

REVISION
0

DRAWING No
W-4

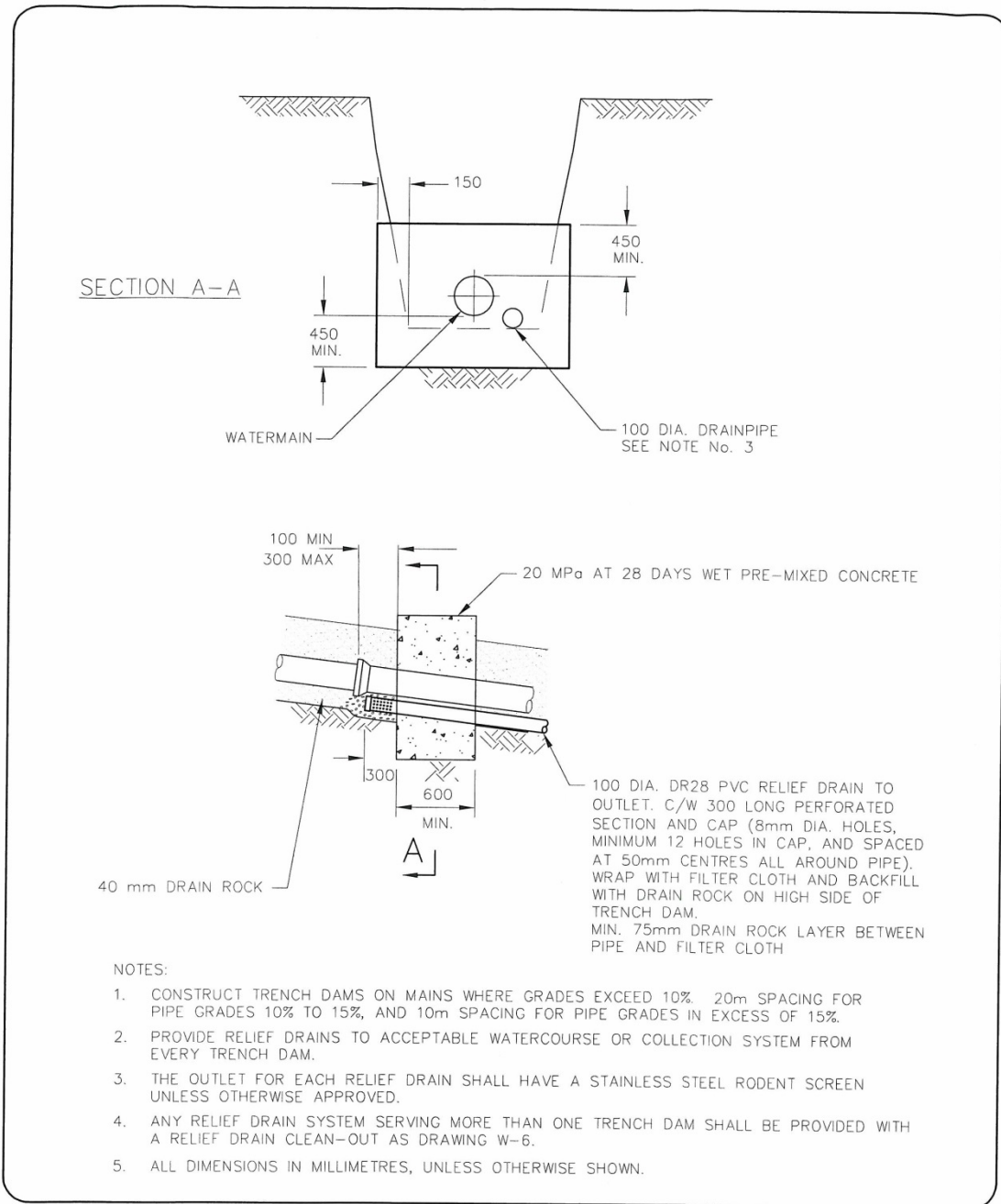

REGIONAL DISTRICT OF NANAIMO

BYLAW No. 1562
COMMUNITY WATER SYSTEM STANDARDS

TRENCH DAM
FORMED CONCRETE TRENCH DAM

REVISIONS			APP.
No.	DATE	DETAILS	W.F.M.
0	JUN/06	BYLAW UPDATE	

REVISION

0

DRAWING No

W-5

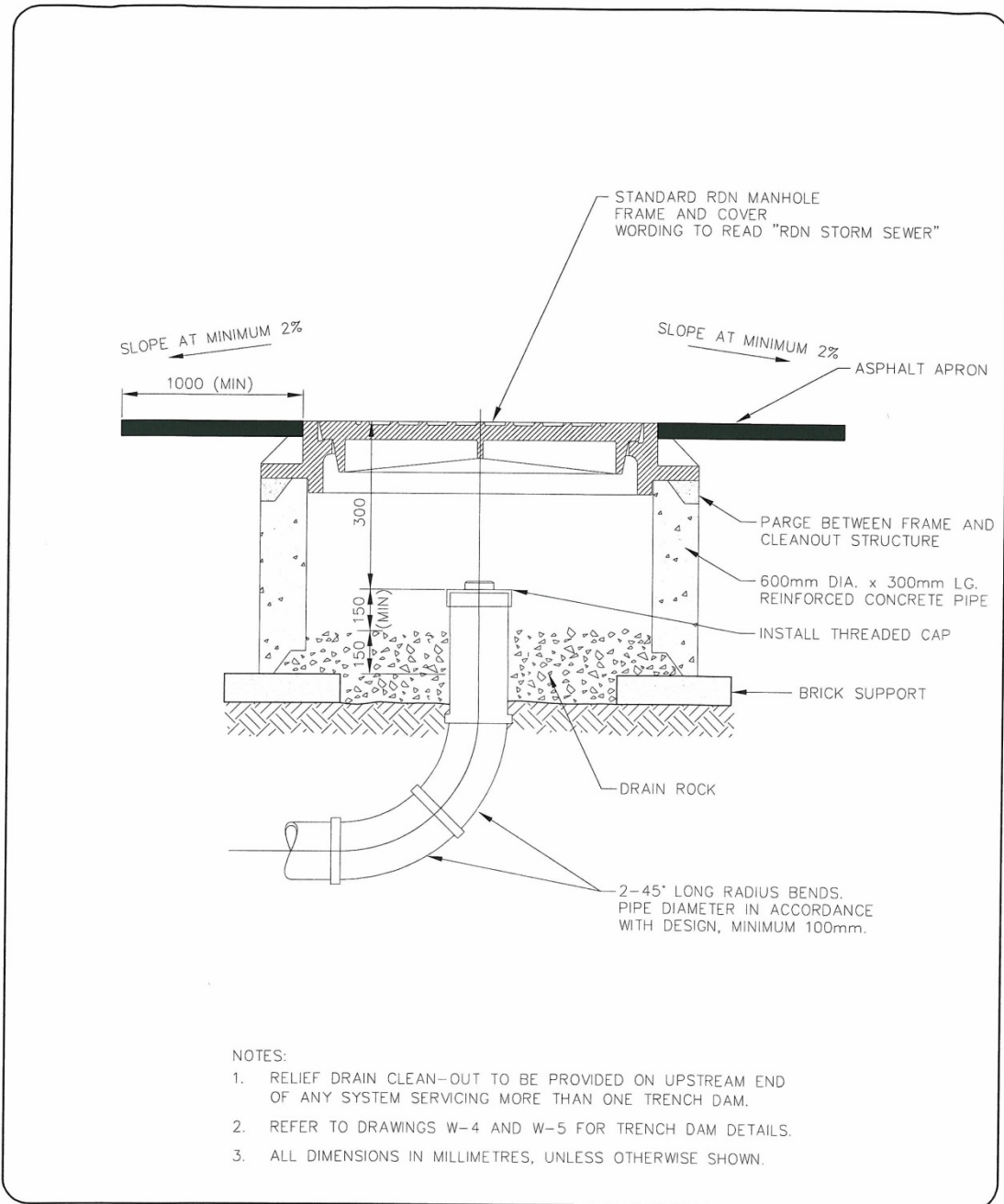

REGIONAL DISTRICT OF NANAIMO

BYLAW No. 1562
COMMUNITY WATER SYSTEM STANDARDS

RELIEF DRAIN CLEANOUT

REVISIONS		APP.
No.	DATE	DETAILS
0	JUN/06	BYLAW UPDATE W.F.M.

REVISION
0

DRAWING No.
W-6

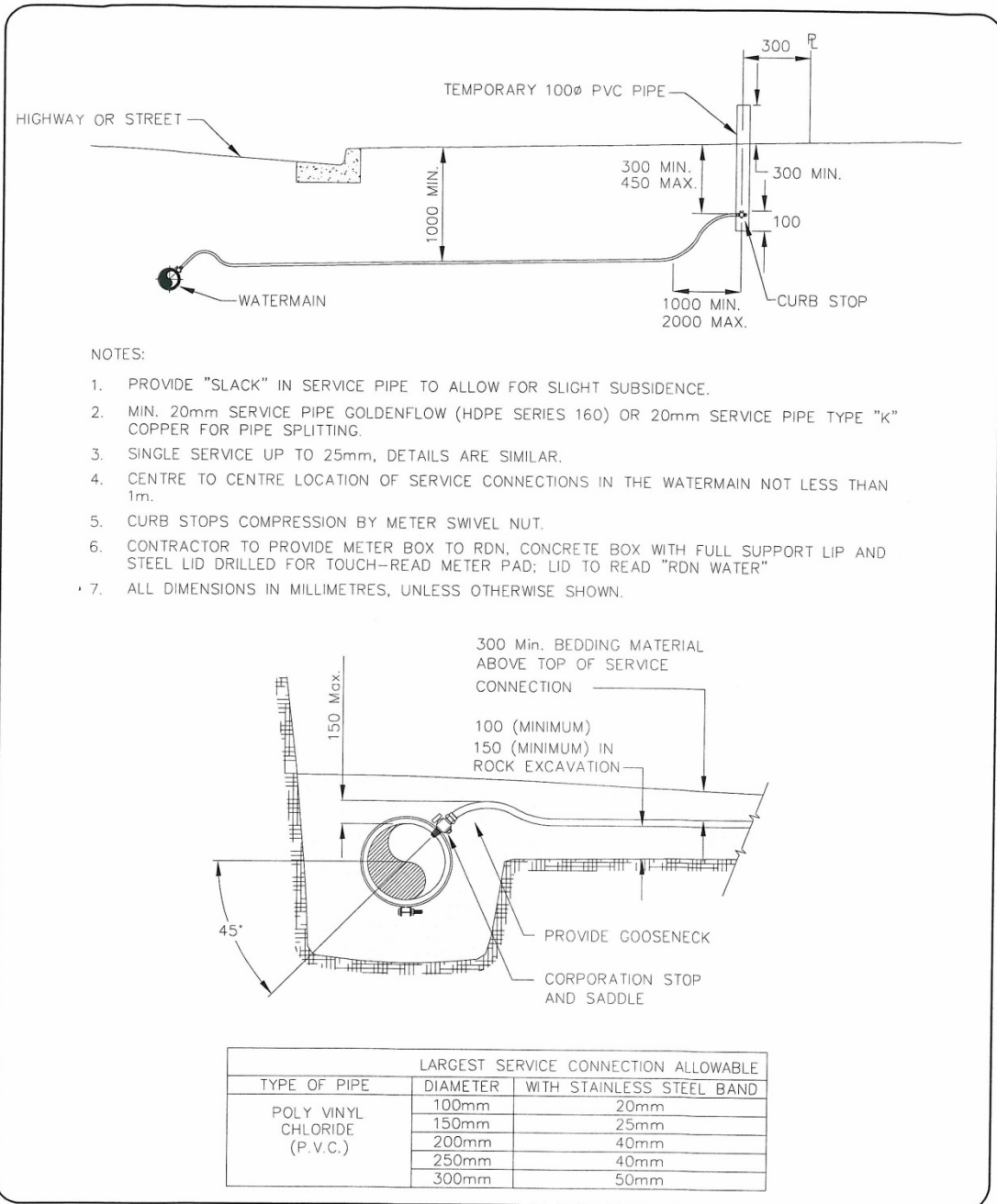

 **BYLAW No. 1562**
COMMUNITY WATER SYSTEM STANDARDS
WATER SERVICE CONNECTION

REVISIONS		
No.	DATE	DETAILS
0	JUN/06	BYLAW UPDATE
		APP. W.F.M.

REVISION
0
DRAWING No.
W-7

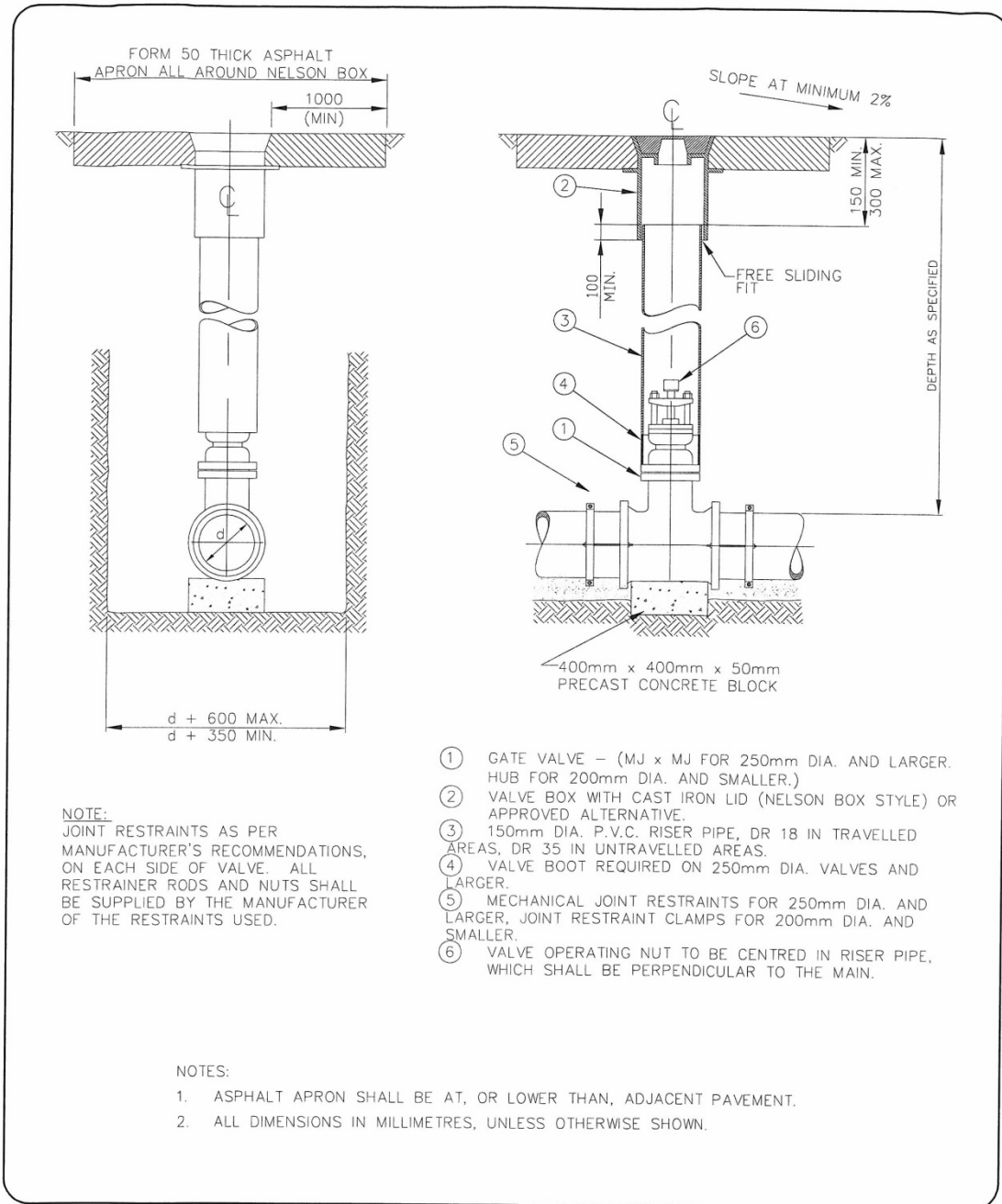

BYLAW No. 1562
COMMUNITY WATER SYSTEM STANDARDS

VALVE

REVISIONS			APP.
No.	DATE	DETAILS	W.F.M.
0	JUN/06	BYLAW UPDATE	

REVISION
0
DRAWING No
W-8

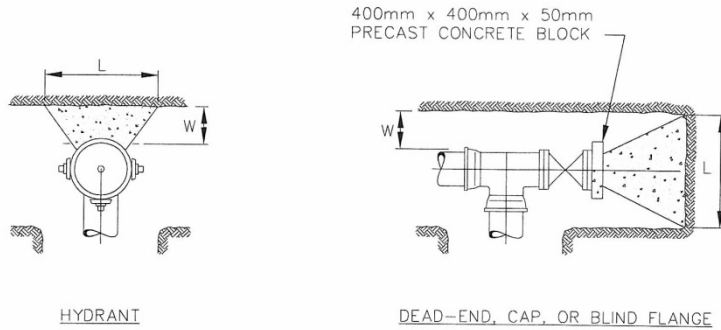

NOTE:
THRUST BLOCK MAY ONLY BE USED
AT END-OF-MAIN HYDRANT. ALL
OTHER HYDRANTS SHALL USE
MANUFACTURED JOINT RESTRAINT
CLAMPS AND MATCHING RESTRAINER
RODS AND NUTS.

MINIMUM THRUST AREAS FOR FITTINGS AT 1030kN/m² PRESSURE
AND FOR SOILS WITH A MINIMUM BEARING OF 96kN/m²
(NOT TO BE USED FOR SOFT CLAY, MUCK, PEAT, ETC.)

FITTING, SIZE "D" (mm)	OUTSIDE OF FITTING TO BEARING FACE "W" (mm)	LENGTH "L" (mm)	HEIGHT "H" (mm)
150	300	600	450
200	350	750	600
250	375	975	750
300	400	1200	900
350	425	1300	1000

NOTES:

1. DIMENSIONS APPLY TO THE LARGER DIAMETER END OF FITTING.
2. ALL THRUST BLOCKS TO BE CONSTRUCTED USING TRUCK DELIVERED WET PRE-MIXED CONCRETE ONLY, WITH MINIMUM 28 DAY COMPRESSIVE STRENGTH OF 20MPa.
3. WHERE GROUND CANNOT BE EXCAVATED TO FREE STANDING UNDISTURBED SOIL, UTILIZE THRUST RESTRAINT DEVICES IN PLACE OF THRUST BLOCK.
4. ALL DIMENSIONS IN MILLIMETRES, UNLESS OTHERWISE SHOWN.



BYLAW No. 1562
COMMUNITY WATER SYSTEM STANDARDS

THRUST BLOCK DETAILS

REVISIONS			APP.
No.	DATE	DETAILS	W.F.M.
0	JUN/06	BYLAW UPDATE	

REVISION
0
DRAWING No.
W-9

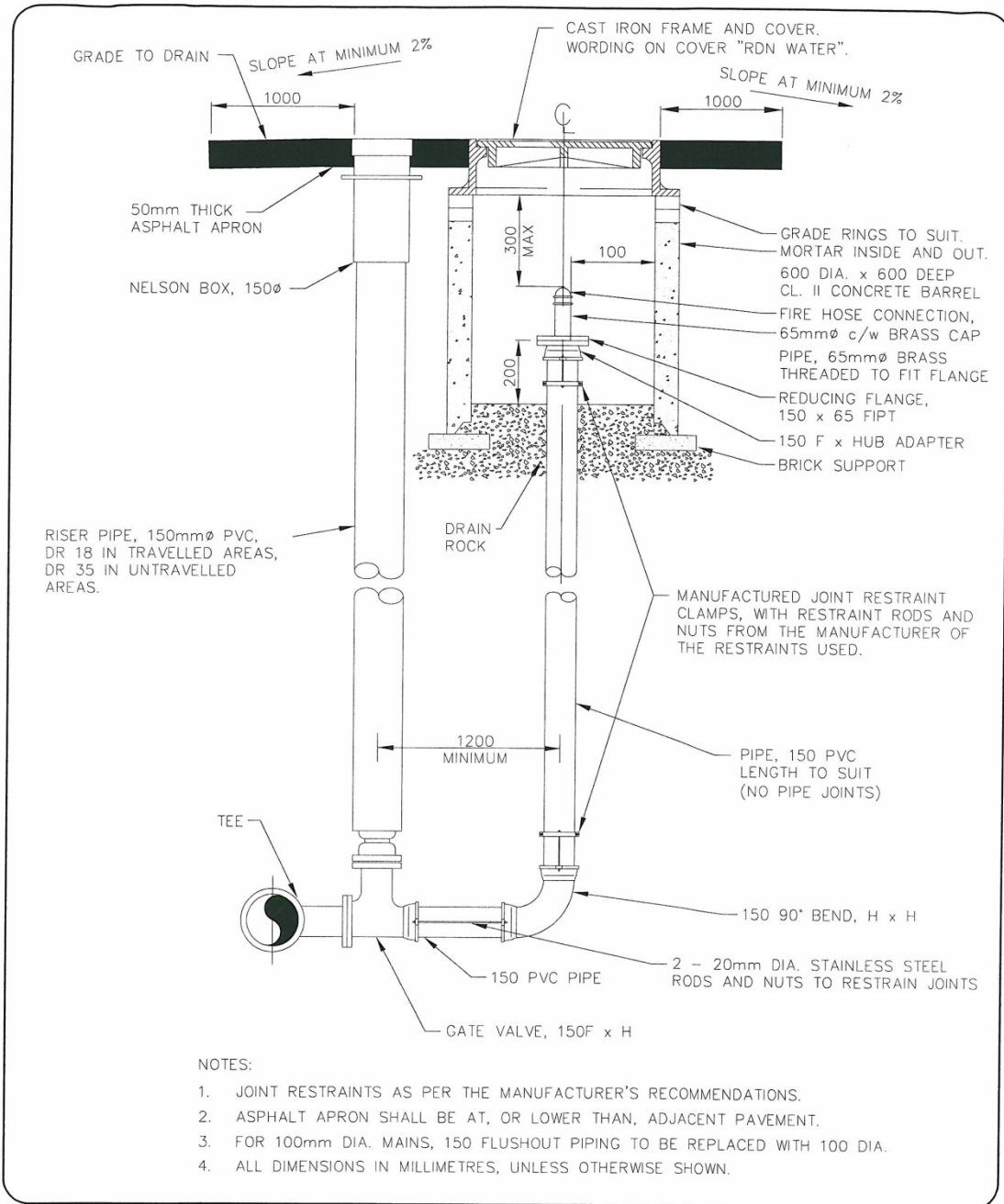

BYLAW No. 1562
COMMUNITY WATER SYSTEM STANDARDS

BELOW GROUND FLUSHOUT

REVISIONS		
No.	DATE	DETAILS
0	JUN/06	BYLAW UPDATE
		APP. W.F.M.

REVISION
0
DRAWING No
W-10

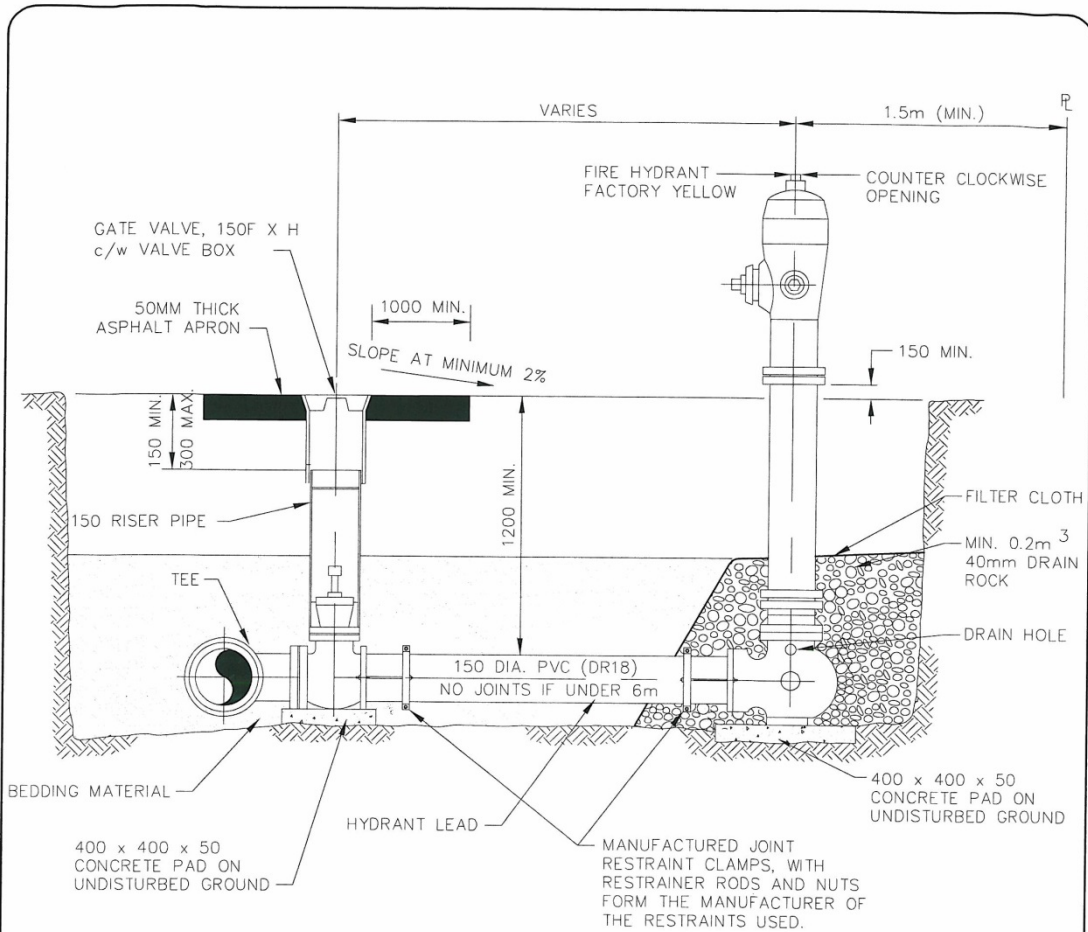

NOTES:

1. PUMPER NOZZLE PERPENDICULAR TO ROAD CENTRELINE.
2. HYDRANT TO BE INSTALLED VERTICAL.
3. MANUFACTURED JOINT RESTRAINERS TO BE USED AT EVERY PIPE JOINT FOR HYDRANT LEADS OVER 6m IN LENGTH. RESTRAINTS REQUIRED AT HYDRANT BOOT AND VALVE FOR LEADS 2m TO 6m LONG. LEADS LESS THAN 2m MAY BE RESTRAINED USING 2–20mm DIA. STAINLESS STEEL THREADED RODS c/w SS NUTS AND SS WASHERS.
4. END-OR-MAIN HYDRANT SHALL BE FULLY RESTRAINED AS PER MANUFACTURER'S RECOMMENDATIONS, OR MAY USE A THRUST BLOCK (SEE W-9 FOR DETAILS).
5. ASPHALT APRON SHALL BE AT, OR LOWER THAN, ADJACENT PAVEMENT.
6. WHERE CURB/GUTTER DOES NOT EXIST, PAVE FROM EDGE OF ROAD SURFACE TO 1m BEHIND HYDRANT AND 2m WIDE.
7. ALL DIMENSIONS IN MILLIMETRES, UNLESS OTHERWISE SHOWN.





BYLAW No. 1562
COMMUNITY WATER SYSTEM STANDARDS

FIRE HYDRANT ASSEMBLY

REVISIONS			APP.
No.	DATE	DETAILS	W.F.M.
0	JUN/06	BYLAW UPDATE	

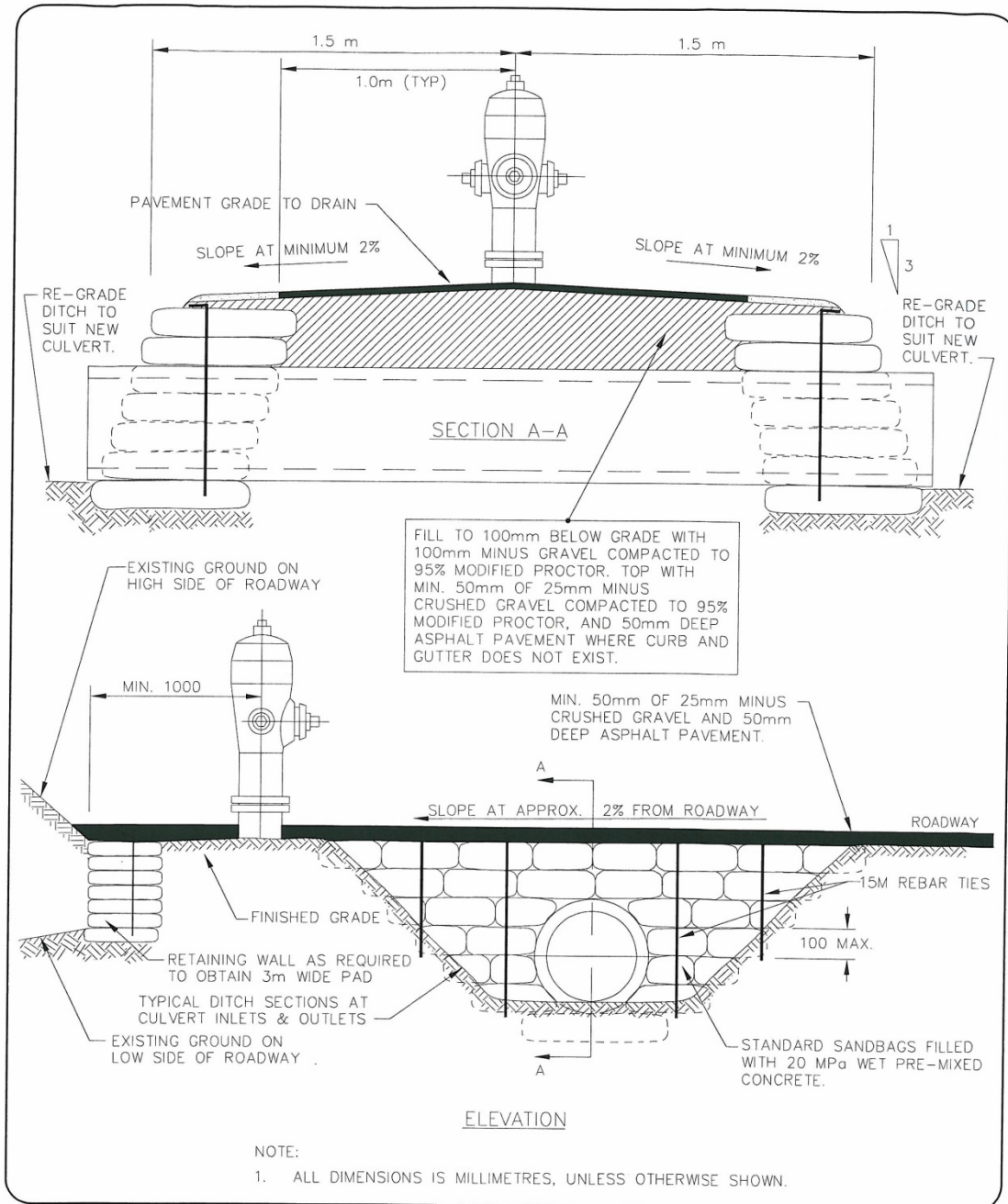
REVISION
0
DRAWING No.
W-12



 **BYLAW No. 1562**
COMMUNITY WATER SYSTEM STANDARDS
HYDRANT ACCESS CULVERT

REVISIONS			APP.
No.	DATE	DETAILS	W.F.M.
0	JUN/06	BYLAW UPDATE	

REVISION
0
DRAWING No
W-13

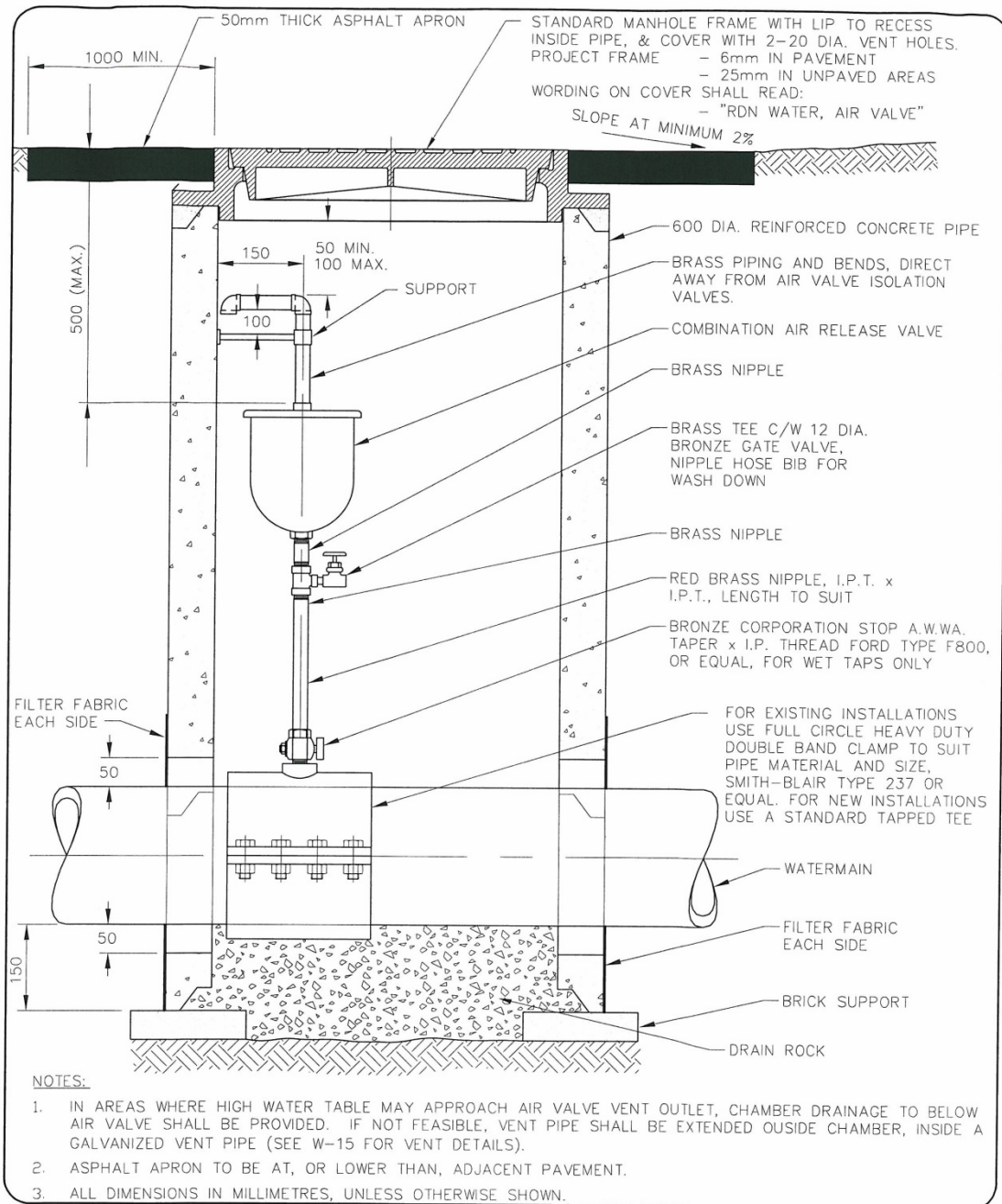

 **BYLAW No. 1562**
COMMUNITY WATER SYSTEM STANDARDS
AIR VALVES UP TO 50mm DIAMETER

REVISIONS		
No.	DATE	DETAILS
0	JUN/06	BYLAW UPDATE
		APP. W.F.M.

REVISION
0
DRAWING No
W-14

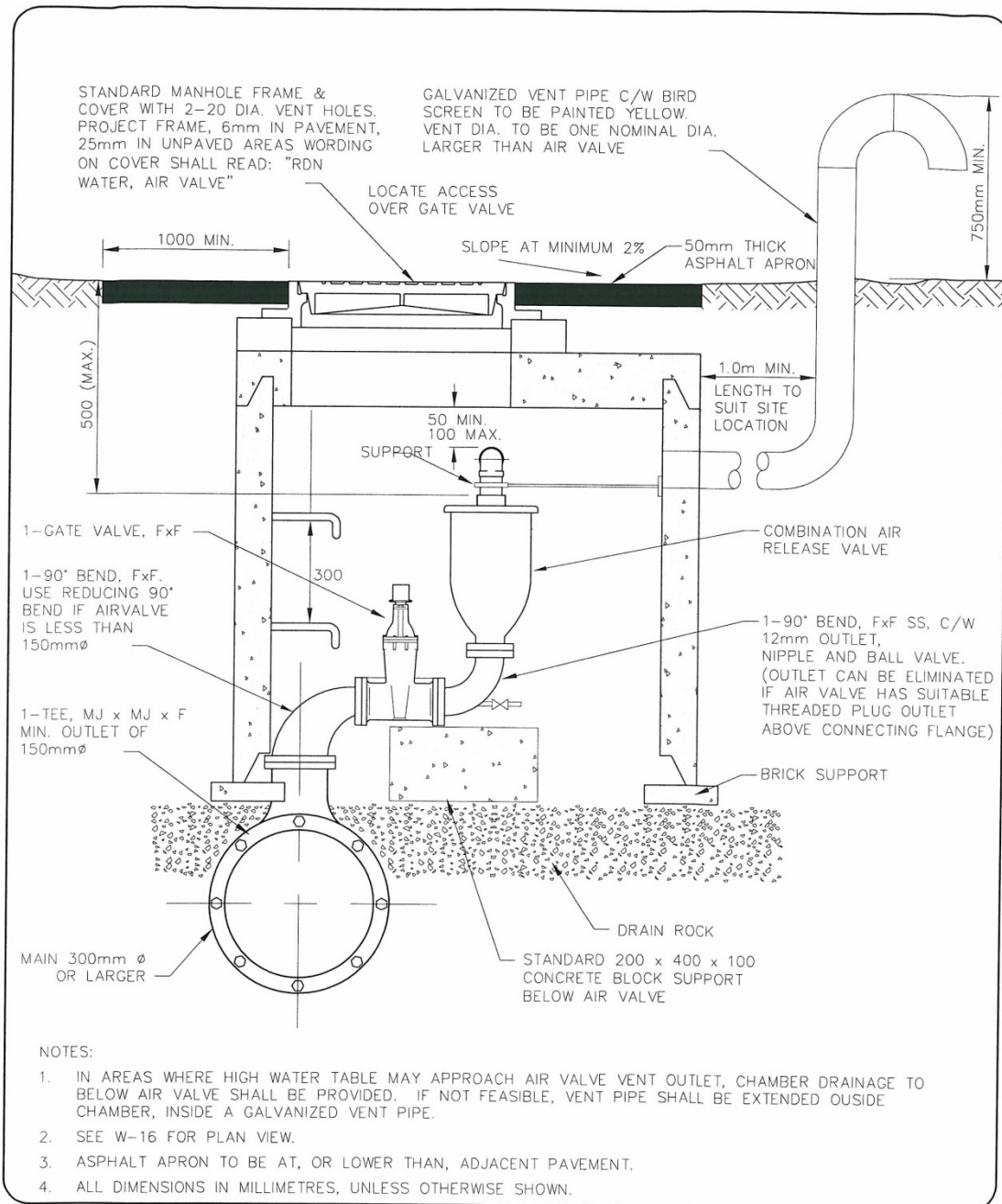

BYLAW No. 1562
COMMUNITY WATER SYSTEM STANDARDS
AIR VALVE 75mm DIA. AND LARGER
SECTION

REVISIONS			APP.
No.	DATE	DETAILS	W.F.M.
0	JUN/06	BYLAW UPDATE	

REVISION
0
DRAWING No.
W-15

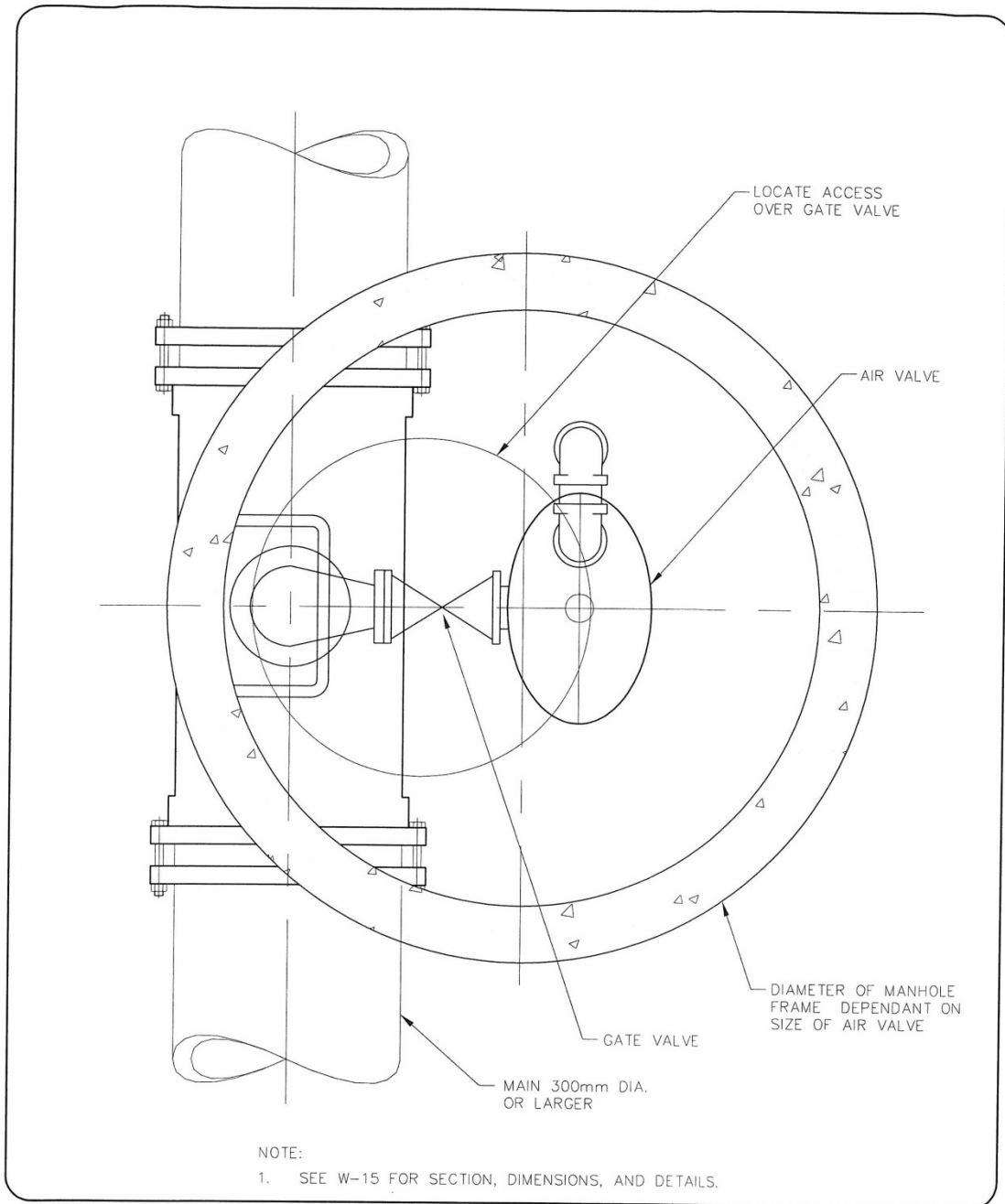

 **BYLAW No. 1562**
COMMUNITY WATER SYSTEM STANDARDS

AIR VALVE 75mm DIA. AND LARGER
PLAN

REVISIONS			APP.
No.	DATE	DETAILS	W.F.M.
0	JUN/06	BYLAW UPDATE	

REVISION
0
DRAWING No
W-16

REGIONAL DISTRICT OF NANAIMO

BYLAW NO. 500

LAKES DISTRICT AND SCHOONER COVE

COMMUNITY WATER SYSTEM STANDARDS

APPENDIX 2

LETTER OF ASSURANCE



LETTER OF ASSURANCE

NOTE:

To be submitted at time of Feasibility Review

To: Manager of Engineering Services
 Regional District of Nanaimo
 6300 Hammond Bay Road
 Nanaimo BC V9T 6N2

RE: _____

 (Project)

Date: _____, 20__.

This will confirm that (Developer _____) has retained (Consultant _____) to provide, design, contract administration, inspection and as-constructed drawings for this project all in accordance with the current bylaws and standards of the Regional District and in accordance with good engineering practice.

(Developer)

This confirms we have accepted this assignment on the above terms.

(Consultant)

**REGIONAL DISTRICT OF NANAIMO
BYLAW NO. 500**

**LAKES DISTRICT AND SCHOONER COVE
COMMUNITY WATER SYSTEM STANDARDS**

APPENDIX 3

CERTIFICATE OF DESIGN



CERTIFICATE OF DESIGN

I, _____, a Professional Engineer registered in the Province of British Columbia, hereby certify that the works as herein set out on the attached drawings entitled _____

have been designed in accordance with the Regional District of Nanaimo Bylaw 500 and/or in accordance with good engineering practice where such design is not covered by the Regional District Bylaw 500.

I have been retained to provide design, supervision, full-time inspection, as-built drawings, and final certification for this project by:

(Name of Client)

I am satisfied that in the contractual mandate which exists between myself and my client, the terms of reference will permit me to render a level of supervision of the construction work which will allow me to put my name and seal to the "Certification of Installed Works" required by the Regional District of Nanaimo, a sample of which is attached to this document and initialed by me.

In the event that my client releases me from this project, or in the event that I find the terms of reference do not permit me to render a level of supervision of the construction work which will allow me to put my name and seal to the form of certification required by the Regional District of Nanaimo, I will notify the Regional District within twenty-four (24) hours verbally and follow it up with written confirmation and clarification.

Signed this _____ day of _____, 20____.

_____, P.Eng.
(signature)

(name printed)

I understand that the "Certification of Installed Works" is to be completed in this format and submitted with the "as-constructed" drawings.

(Engineer)

**REGIONAL DISTRICT OF NANAIMO
BYLAW NO. 500**

**LAKES DISTRICT AND SCHOONER COVE
COMMUNITY WATER SYSTEM STANDARDS**

APPENDIX 4

CERTIFICATION OF INSTALLED WORKS



CERTIFICATION OF INSTALLED WORKS

NOTE: To be completed in this format and submitted with the 'As-Built' drawings

Location of the Construction Site and Works: (Legal Description / Location)

all within the Regional District of Nanaimo, British Columbia.

I, _____, a Registered Professional Engineer (Reg. No. _____) in the Province of British Columbia, hereby certify:

1. THAT the following construction tests were carried out to confirm that construction met the specifications required:

- a) _____
- b) _____
- c) _____
- d) _____
- e) _____
- f) _____

2. THAT I was able to monitor the construction and provide a level of supervision of the construction work sufficient to be able to confirm that the specifications in force and effect by the Regional District of Nanaimo and in the applicable design drawings for the said Works were generally met during the Construction Period; and

3. THAT the accompanying plans labeled:

- (i) _____
- (ii) _____
- (iii) _____

accurately record the materials, grades, inverts, offsets and dimensions of the constructed work.

DATED this _____ day of _____, 20 _____.

Engineer (signature & seal)

Engineering Firm

**REGIONAL DISTRICT OF NANAIMO
BYLAW NO. 500**

LAKES DISTRICT AND SCHOONER COVE

COMMUNITY WATER SYSTEM STANDARDS

APPENDIX 5

**OUTLINE FOR WELLHEAD PROTECTION REPORT
(MINIMUM REQUIREMENTS)**

OUTLINE FOR WELLHEAD PROTECTION REPORT

(Version: November 19, 2009)

Acceptable Preliminary Well Head Protection Plan (WHPP) for New Wells supplied to the RDN by/for private land development (to be prepared by a qualified professional in ground water and well head protection and approved by the RDN prior to appointment).

Below are the minimum requirements for this Document:

Name of the Plan (WHPP), describe the well #'s, legal location of well(s), client, development for which the well is being provided and client file number.

1.0 INTRODUCTION

2.0 BACKGROUND

- 2.1 SITE DESCRIPTION (including a sketch of the current and proposed lot boundaries, locations of wells on current and proposed lots plus on adjacent properties, locations of sewage disposal fields, drainage ditches, dry wells or infiltrations areas, all surface bodies [either permanent and/or intermittent] and other relevant information)
- 2.2 OVERVIEW OF WELL PROTECTION PLANNING
- 2.3 SCOPE OF WORK

3.0 NOTES of MEETINGS with RDN, DEVELOPER, CONSULTANT, etc.

4.0 NOTES of DISCUSSIONS WITH VIHA STAFF

5.0 HYDROGEOLOGIC CONDITIONS

- 5.1 CLIMATE
- 5.2 TOPOGRAPHY AND SURFACE WATER DRAINAGE
- 5.3 GEOLOGY
- 5.4 LOCAL AQUIFERS (include sketch showing aquifer extent and boundaries if present, well head and static water level elevation, areas of recharge and discharge and direction of groundwater flow under natural conditions)
- 5.5 LOCAL GROUNDWATER USE (number and location of wells and estimates of seasonal water use)
- 5.6 WATER QUALITY (identify where the water quality exceeds guidelines and specifically iron and manganese)
- 5.7 NEW AND EXISTING WELLS ON PROPOSED LOTS (to include information on total well depth and depth of fractures producing groundwater or well screens. Also include testing and yield evaluation results. All pumping test data and well logs to be included with report)
- 5.8 COMPLIANCE OF WELLS WITH BC GROUNDWATER PROTECTION REGULATIONS
- 5.9 ASSESSMENT OF POTENTIAL FOR MUTUAL WELL INTERFERENCE

6.0 CURRENT ZONING OF WELL HEAD AND PROPOSED AND ADJACENT CURRENT LAND USE (within minimum 1 kilometre of well(s))

7.0 PRELIMINARY WELL HEAD PROTECTION PLAN

- 7.1 WELL HEAD PROTECTION AREA
- 7.2 AREAS OF POTENTIAL ENVIRONMENTAL CONCERN
 - 7.2.1 WELLS AS A POTENTIAL CONDUIT TO THE SUB-SURFACE
 - 7.2.2 SEWAGE DISPOSAL SEPTIC FIELDS
 - 7.2.3 STORMWATER DISPOSAL
 - 7.2.4 HEATING OIL ABOVE GROUND AND UNDERGROUND STORAGE TANKS
 - 7.2.5 HISTORICAL OPERATIONS (ON SITE AS WELL AS ADJACENT TO SITE)
 - 7.2.6 POTENTIAL FOR SALTWATER INTRUSION
- 7.3 DETERMINATION OF WELL HEAD CAPTURE ZONE (include background on methodologies to determine zones, why specific method was used and assumptions incorporated into analysis)
- 7.4 RECOMMENDATIONS FOR WELL PROTECTION AREA MANAGEMENT
 - 7.4.1 WELL CONSTRUCTION AND CLOSURE ISSUES
 - 7.4.2 SEWAGE DISPOSAL SEPTIC FIELD SYSTEMS
 - 7.4.3 STORMWATER DISPOSAL MANAGEMENT
 - 7.4.4 HEATING OIL UNDERGROUND STORAGE TANKS
 - 7.4.5 MONITORING SPECIFIC TO SALTWATER INTRUSION
 - 7.4.6 WATER QUALITY MONITORING

8.0 CONCLUSION AND RECOMMENDATIONS (ALSO INCLUDE ANY COST ASSOCIATED WITH RECOMMENDATIONS)

9.0 COMMITMENT FOR ANNUAL MONITORING AND REPORTING ON WHPP TO RDN

**REGIONAL DISTRICT OF NANAIMO
BYLAW NO. 500**

**LAKES DISTRICT AND SCHOONER COVE
COMMUNITY WATER SYSTEM STANDARDS**

APPENDIX 6

STANDBY IRREVOCABLE LETTER OF CREDIT

[BANK LETTERHEAD]

Letter of Credit No.	_____	Amount:	_____
Applicant	_____	Initial Expiry Date:	_____
	_____	Beneficiary:	_____

For the account of _____
(Name of Customer)

up to an aggregate amount of _____ available on demand.

Pursuant to the request of our customer, we hereby establish and give you a Standby Irrevocable Letter of Credit in your favour in the above amount which may be drawn on by you at any time and from time to time, upon written demand for payment made upon us by you, which demand we shall honour without enquiring whether you have the right as between yourself and the said customer to make such demand, and without recognizing any claim of our said customer, or objection by it to payment by us.

This Letter of Credit relates to those Regional District of Nanaimo services and financial obligations set out in an Agreement between the customer and the Regional District of Nanaimo and briefly described as:

The amount of this Letter of Credit may be reduced from time to time as advised by notice in writing to us by the Regional District of Nanaimo.

Partial or full drawings may be made.

This Letter of Credit shall expire at 3:00 p.m. on _____. This Letter of Credit will continue in force for a period of 1 year, but shall be subject to the condition hereinafter set forth.

It is a condition of the Letter of credit that it shall be deemed to be automatically extended without amendment from year to year from the present or any future expiration date hereof, unless at least 30 days prior to the present or any future expiration date, we notify you in writing by registered mail, that we elect not to consider this Letter of Credit to be renewable for any additional period. This Letter of Credit is subject to the Uniform Custom and Practice for Documentary Credits (1993 Revision) International Chamber of Commerce Publication No. 500.

DATED at _____, British Columbia, this ____ day of _____, 20__.

(Name of Bank)

(Address of Bank)

PER:

(Authorized Signature)

REGIONAL DISTRICT OF NANAIMO

BYLAW NO. 500

SCHEDULE '4D'

COMMUNITY SEWER SYSTEM STANDARDS

REGIONAL DISTRICT OF NANAIMO

BYLAW NO. 500

SCHEDULE '4D'

STANDARDS FOR PUBLIC SEWER SYSTEMS

TABLE OF CONTENTS

1.	GENERAL	3
	1.1 Definitions	3
	1.2 Applications and Approvals	4
	1.3 Drawings and Specifications	6
2.	DESIGN	6
	2.1 Sewage Quantity	6
	2.2 Sewage Quality	9
	2.3 Hydraulics	9
	2.4 Sewers	10
	2.5 Pumping Systems	11
3.	CONSTRUCTION	11
	3.1 Sewers	12
	3.2 Pumping Stations	15

1. GENERAL

1.1 Definitions

In these Standards unless the context otherwise requires,

ADWF means Average Dry Weather Flow;

AWWF means Average Wet Weather Flow;

B.O.D. means the quantity of oxygen utilized in the biochemical oxidation of organic matter under standard laboratory procedure in 5 days at 20°C, expressed in mg/l;

collection facility means a facility used for the collection and conveyance of sanitary sewage;

comminuted garbage means the wastes from the preparation, cooking and dispensing of food that have been shredded to such a degree that all particles will be carried freely under the flow conditions normally prevailing in public sewers, with no particle greater than 6 mm in any dimension;

design flow means peak sewage flow plus peak stormwater infiltration;

direct service area means land and improvements directly served by the proposed facility;

facilities means sewers, sewage treatment and disposal plants, pumping stations and other works necessary thereto, and outlets for carrying off, treating and disposing of sewage, and includes any and all works, structures, lands, conveniences, incidental to and necessary for a sewerage system;

garbage means solid wastes from domestic and commercial preparation, cooking and dispensing of food, and from the handling, storage and sale of produce;

industrial waste means liquid waste from industrial manufacturing processes, trade or business, as distinct from sanitary sewage;

lateral sewer means sewer serving more than a single subdivided parcel;

lpcpd means litres per capita per day;

l/s means litres per second;

member municipality or **member** means a municipality or improvement district within the Regional District of Nanaimo;

mg/l means milligrams per litre;

MPa means megapascals (1000kPa);

m³/ha means cubic metres per hectare;

m³pd means cubic metres per day;

pH means the logarithm of the reciprocal of the weight of hydrogen ions in grams per litre of solution;

ppm means parts per million parts;

sanitary sewage means sewage having a quality substantially equal to that of normal domestic sewage;

sanitary sewer means a sewer which carries sewage and to which storm, surface and ground waters are not intentionally admitted;

service connection means a sewer connecting a subdivided lot to the lateral sewer;

sewage treatment plant means an arrangement of structures and devices used for treating sewage;

stormwater infiltration means the infiltration of groundwater or inflow of stormwater through leaks and connections into the system;

suspended solids means solids that either float on the surface of, or are in suspension in water, sewage or other liquids, and which are removable by laboratory filtering;

tributary area means all land in the service area tributary to the proposed facility;

1.2 Applications and Approvals

1) General

Applications shall be made to the District for all proposed construction of sewerage facilities within the area of the District. All applications shall be made in not less than three steps as hereafter summarized:

- a) the request to the District for a review of the feasibility of the proposed work;
- b) the submission of detailed construction plans and specifications to the District for approval;
- c) the submission of a signed statement from a registered professional engineer that the work has been completed in accordance with these Standards and is ready for acceptance by the District.

2) Feasibility Review

All proposed construction of sewerage facilities within the area of the Regional District shall be submitted to the Regional District in duplicate for a feasibility review prior to commencement of any detailed design or construction. The submission shall include a plan of the proposed construction and of the area it will serve.

The District will review the proposal and submit a written report to the applicant which will comment on the feasibility of sewerage service.

The review report may also include a general layout of the proposed works that is compatible with the District's master planning for the subject area, and that indicates approximate locations, minimum pipe sizes, design quantities, design qualities, and points of connection to both the downstream system for discharge and possible upstream system or systems for future extensions.

Should the applicant desire to proceed with the proposed work on the basis of the feasibility review, the District shall be so notified and detailed design may commence.

3) Detailed Design

Detailed design shall be done by a registered professional engineer and shall conform to the feasibility review, these Standards and all applicable legislation.

Following detailed design, plans and specifications shall be submitted in duplicate to the District for approval before any construction is started.

The District will review the detailed plans and specifications, mark these with any necessary revisions, and return the plans and specifications to the applicant either approved as noted or with a request for re-submission, as the case may be. Re-submissions shall be carried out as above until the District approves the detailed plans and specifications.

4) Permits and Certificates

In the case of a new treatment and disposal facility, the District will make application in the District's name to the Ministry of the Environment for a permit.

All other submissions necessary to proceed with construction shall be the responsibility of the applicant.

5) Construction

The applicant shall construct the proposed work in accordance with the plans and specifications approved by the District.

The District will inspect construction from time to time for conformity to these Standards. There will be no charge for such inspections. The applicant shall be responsible for construction layouts, detailed field supervision of the work and the preparation of as constructed drawings.

6) Completion, Acceptance and Connection

Once the work is completed, a statement by a registered professional engineer shall be submitted to the Regional District along with two sets of as-constructed drawings certifying that the work has been constructed under the engineer's supervision and that it is completed in accordance with the as-constructed plans and specifications. One set of as-constructed plans shall be on 3 mil mylar material.

The Regional District shall then make a final inspection, and when it is satisfied the work is acceptable the applicant shall:

- a) guarantee the workmanship and performance of the work for a period of one year for collection systems and five years for treatment and disposal systems by way of cash or an irrevocable letter of credit in the amount of 5% of the cost of construction as certified by a professional engineer; and

b) convey the works to the Regional District.

Upon compliance with the above items, the Regional District shall issue a written statement that the new works can be connected to the District's existing system. Such connection shall be undertaken by the applicant under the direct supervision of the District or by the District at cost to the applicant.

1.3 Drawings and Specifications

1) Drawings

Drawings shall be done in metric units on ISO A1 size paper, 594 mm by 841 mm.

All drawings shall include a key plan, location plan and plans and profiles or sections of the proposed work to a suitable scale. Sufficient blow-ups to indicate construction details shall be included.

For sewer pipes, the plans shall show the offset of the work in relation to property lines and the profiles shall show pipe grades, ground surface, underground utilities, basement elevations and any design grade limitations. Detailed drawings shall be complete with manhole details, trench sections, trench dam details, and details of service connections. Scales shall normally be 1:500 horizontal and 1:50 vertical.

For other work, the drawings shall clearly indicate all construction details and summarize design and operational data such as pump characteristics, hydraulic profiles and parameters relating to the design and operation of treatment systems.

As constructed drawings shall be reproducible 3 mil mylars.

2) Specifications

Specifications shall incorporate the general requirements of these standards and shall be expanded to include detailed specifications to complement the drawings.

2. DESIGN

2.1 Sewage Quantity

- 1) In general, provision shall not be made in sanitary sewer system designs for the deliberate addition of stormwater.
- 2) Design sewage rates of flow shall be computed by adding peak sewage flow to peak stormwater infiltration.
- 3) Peak sewage flow shall be established by multiplying the peak unit AWWF shown in Section 2.1 by the design contributory population except in industrial and commercial areas where other methods, approved by the District, may be used.
- 4) Peak stormwater infiltration shall be calculated on the basis of 10 m³/ha of design tributary area per day.
- 5) Design contributory populations shall be computed in accordance with the Regional District of Nanaimo population predictions or with the ultimate planned development in the tributary area, whichever is the larger.

- 6) In the absence of detailed population information, the following minimum design population densities shall be used:
- | | | |
|----|--|----------------|
| 1) | One dwelling unit/parcel | 30 persons/ha |
| 2) | two dwelling units/parcel | 50 persons/ha |
| 3) | Multiple dwelling unit development | 125 persons/ha |
| 4) | Industrial and Commercial zoning - equivalent of | 50 persons/ha |

REGIONAL DISTRICT OF NANAIMO

BYLAW NO. 500

TABLE 1

DESIGN - PEAK SEWAGE FLOW

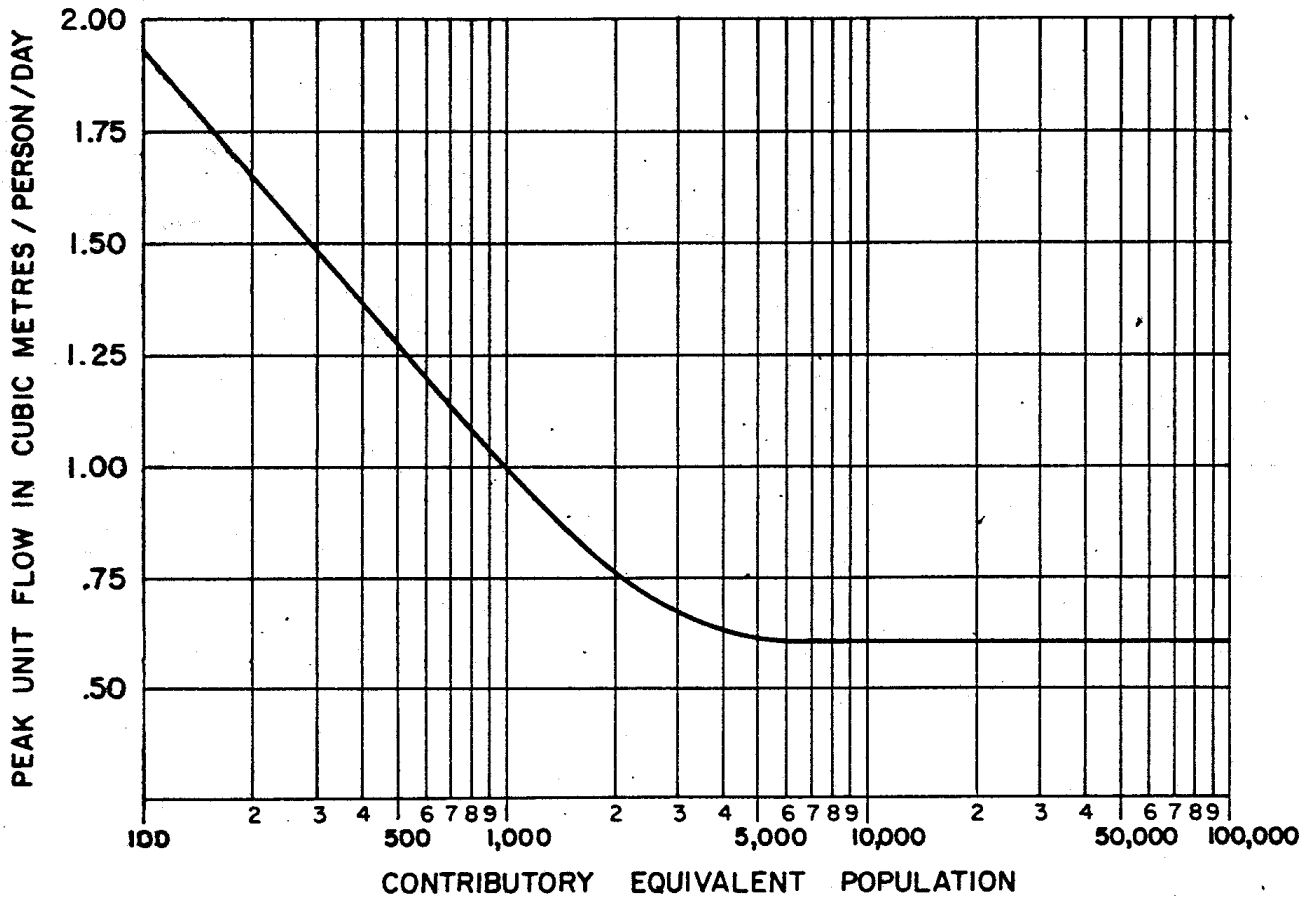

2.2 Sewage Quality

- 1) Design quality criteria for domestic sewage shall be as follows:

Sewage Quantity (ADWF) in the Direct Service Area	Constituent	Average Normal
less than 50m ³ pd	BOD - 5 day 20°C	1000 mg/l
	Suspended Solids	800 mg/l
	pH	4 - 10.5
	Temperature	79°C
50 to 450m ³ pd	BOD - 5 day 20°C	400 mg/l
	Suspended Solids	300 mg/l
	pH	5 - 9.5
	Temperature	66°C
over 450m ³ pd	BOD	200 mg/l
	Suspended Solids	200 mg/l
	pH	5.5 - 9.0
	Temperature	54°C

- 2) Where the existing industrial and/or commercial developments will be connected to the sewer system, the District may require that flow sampling be carried out to determine the design loadings; re-treatment of wastewater prior to discharge to the District's facilities may be required.

2.3 Hydraulics

- 1) All facilities shall be designed to convey peak sewage flow plus peak stormwater infiltration (design flow).
- 2) Sewers shall be designed to carry design flow at a minimum velocity of 0.67 m/s. When carrying the design flow the maximum depth of flow shall not exceed the following:

250 mm and smaller	- one-half pipe diameter
300 mm to 400 mm	- three-quarter pipe diameter
50 mm and over	- full pipe diameter
- 3) Service connections shall be designed for a minimum velocity of 0.90 m/s when flowing full.
- 4) The minimum velocity in a forcemain shall be 0.76 m/s.
- 5) Manning's Roughness Coefficient of 0.013 shall be used for design of sewers and service connections. Manning's Roughness Coefficient of 0.015 shall be used for forcemains and outfalls.
- 6) Manholes shall be designed to incorporate a minimum elevation differential of 30 mm in addition to the normal grade of the lateral sewer, wherever a horizontal deflection exceeding 450 occurs.

- 7) Pumping stations and treatment and disposal works shall be designed to process all peak sewage flows plus stormwater infiltration. Bypassing of works to disposal shall not be allowed except under emergency conditions.

2.4 Sewers

1) Lateral Sewer Size

No lateral sewer shall be less than 200 mm in diameter, except that 150 mm diameter will be acceptable in the final section of a lateral that cannot be extended.

2) Service Connections

No service connections shall be less than 100 mm in diameter. Service connections serving more than two dwelling units shall be sized in accordance with design flows and available grades. No service connections shall exceed a length of 15.0 m as measured horizontally between the lateral sewer and the property line, unless adequate cleanout facilities are provided.

3) Depths

Depths of all sewers shall be such that all basements in the area the sewer is intended to serve can be drained by gravity, except that lift stations from individual homes may be acceptable under special circumstances of location and topography.

Minimum cover on lateral sewers shall be 1.5 m in travelled roads and 1.0 m elsewhere unless adequate concrete protection is used.

Minimum cover on service connections shall be 0.75 m unless adequate concrete protection is used.

Where service connection standpipes at property line exceed 1.8 m in depth, the standpipe shall be constructed in two or more sections, each having a length not exceeding 1.8 m.

4) Manholes

In general, distances between manholes shall not exceed 120 m.

Manholes shall be located at grade changes, at sewer size changes, at the upstream end of all sewers, at the junctions of all sewers and at the junctions of lateral sewers and service connections 150 mm in size and larger.

Cleanouts will be permitted at the upstream end of lateral sewers not designed for extension.

Where the difference in elevation between incoming and outgoing sewers exceeds 600 mm, standard drops shall be used as shown in the Standard Drawings.

5) Curved Sewers

Wherever possible, curved alignment shall be avoided.

Horizontal curves may be permitted where the configuration of the right of way permits curvature at a constant offset.

Vertical curves may be permitted under special circumstances where excessive cuts are to be avoided and where energy dissipation is required.

Radius of curvature shall be uniform throughout the curves and shall not be less than 60.0 m. Compound curves shall not be permitted between manholes.

6) Location of Sewers

Wherever possible, sewers shall be located on the high side of the street where only the high side is served by the lateral and on the low side of the street where both sides are served by the lateral. Wherever possible, the sewer shall be located on the opposite side from the watermain and at a constant offset from the property line.

Where practical, sanitary lateral sewers and service connections shall not be less than 3.0 m distant from all water pipes.

2.5 Pumping Systems

1) Pumping Stations

This section applies to all pumping stations other than those serving individual homes, except that large pumping stations will be considered as special cases.

Pumping stations shall be constructed using first class material of recognized quality for sewerage service.

As a minimum requirement all stations shall be equipped with alternating duplex pumping units of the following type:

- a) Pneumatic Ejectors;
- b) Grinder or Vortex type pumping units capable of handling of 75 mm diameter solid;
- c) Non-clog type pumping units capable of handling a 75 mm diameter solid.

Duplex pumps shall be designed for 100% standby at design flow. In stations employing more than two pumps, the pumps shall be capable of pumping design flow with any one pump out of service.

Stations other than those employing submersible pumping units shall have the pump motors and controls located in a ventilated, heated, lighted and dehumidified area.

All stations shall have a wet well capacity providing not more than 12 hours detention at minimum design flows and a frequency of pump start-up of not less than 5 minutes at peak flows.

All piping and valves shall have a minimum diameter of 100 mm.

All stations shall have acceptable emergency overflows for electrical and mechanical failures. Such overflows shall not be designed to meet excess flows.

Pump selection shall allow forcemains to be designed for a 0.76 m/s minimum velocity and a detention time at minimum design ADWF not exceeding 12 hours.

All pumping stations shall be equipped with high level and motor overload alarms acceptable to the District.

2) Lift Stations for Individual Homes

Lift installations serving single individual homes shall conform to the requirements of all relevant legislation.

3. CONSTRUCTION

3.1 Sewers

1) Pipes and Fittings

Pipes for sewers and service connections shall comply with the following:

Size	Specification
Connections:	
100 mm & 150 mm	Asbestos Cement, Building Sewer, CGSD 34-GP-96 Standard
100 mm & 150 mm	PVC, SDR 28, ASTM D 3034 Specification
Sewer:	
150 mm & up	Asbestos Cement, Minimum Class 2400, ASTM C 428 Specification
150 mm to 300 mm	PVC, SDR 35, ASTM D 3034 and ASTM D 2414 Specifications
150 mm to 600 mm	Concrete minimum Class B, non-reinforced, ASTM C 14 Specification
300 mm & up	Concrete, reinforced, ASTM C 76 Specification

Fittings for service connections shall be the same material and strength as the pipe and shall be recommended for use by the pipe manufacturer.

2) Concrete

Concrete for sewer work shall be ready-mix and shall be supplied from one approved dealer of ready-mix concrete. The equipment and methods of the ready-mixing plant shall conform to CSA A 23.1.

All concrete shall contain an air entrainment agent to provide 4 to 6% air content.

Concrete mixes for the following classes of concrete shall be designed as follows:

Class	Minimum Compression Size Strength at 28 Days MPa	Nominal Coarse Aggregate mm	Maximum Slump mm	Use
A	21	25	75	Septic Tanks & Manhole Bases
B	14	25	100	Mass Concrete

3) Reinforcing Steel

Reinforcing bars shall be new deformed bars free of loose scale, grease and encrusted concrete. Reinforcement shall be intermediate grade steel conforming to CSA G 30.12, Grade 40.

Wire for tying reinforcement shall be black annealed wire not less than 1.6 mm.

4) Bedding Material

Pipe bedding shall comprise a well graded 19 mm minus gravel or crushed rock which compacts readily. Bedding material shall extend for 100 mm beneath the pipe to 300 mm above the top of the pipe. *See Table 2 of this Schedule.*

5) Trench Dams

Trench dams shall be used where trench grade exceeds 10%. See Table 3 of this Schedule.

6) Manholes

Manholes shall be minimum 1050 mm diameter reinforced concrete sections conforming to ASTM C.78 Specifications. Joints shall be watertight. Covers shall be cast iron. Drop connections shall be provided when drops exceed 600 mm. *See Tables 4, 5 and 6 of this Schedule.*

7) Connection, Testing and Flushing

Connection to the District's system shall be carried out under the direct supervision of the District. Forty-eight hours notice shall be given to the District of intent to connect.

The District will install a plug(s) in the existing pipe(s) in the District manhole(s) or end of clean-out(s) to permit testing and flushing to proceed.

Leakage tests shall be made on all the sewers and manholes. Each run of sewer shall be tested immediately after completion of the manholes included in the test. Any arrangement of testing equipment which will provide readily observable and reasonably accurate measurements of leakage under the specified conditions will

be acceptable. Leakage tests shall be conducted by measuring the exfiltration of water from the filled sewer during the test period.

Exfiltration tests shall be conducted by plugging all openings in the test section, except the upstream manhole and filling it with water so that the effective head above the crown of the highest pipe in the section of the sewer under test is at least 600 mm. The maximum hydrostatic head in an exfiltration test shall be 3.0 m. T-branches shall be installed on the sewer from which shorter sections with pressure head of not more than 3.0 m can be tested, after inserting a length of vertical pipe. The lower end of the upper section(s) of such steep grades shall be closed by letting an inflatable test plug on a rope into the lower end of the section to be tested. The amount of leakage shall be observed by measuring the quantity of water necessary to maintain the level in the manhole or vertical pipe at a testing Tee for a period of at least 1 hour. Calculation of the leakage by measuring the drops in the water level in the upstream manhole or vertical pipe at a testing Tee is not acceptable.

For all sewers the allowable leakage in litres = $HDL/840$

Where H = duration of test in hours
 D = inside diameter of the pipe in millimetres
 L = length of pipe in the test section in metres.

No leakage shall be permitted in manholes.

If leakage exceeds the permissible amount, the leak or leaks shall be detected, approved corrective measures taken, and the sections re-tested. The corrective measures may comprise removal and replacement of the defective work.

If excessive infiltration of groundwater is observed during the final inspection, the cause of infiltration shall be found and corrective measures taken.

Prior to final inspection of the installed and tested sewer, each run shall be flushed by passing through a large flow of water and a rubber ball or test plug having a minimum dimension of at least 9/10 of the diameter of the pipe. All foreign material found in the sewers and appurtenances shall be removed.

Discharge of flushing water to the existing sewers will not be permitted, except with the express approval of the District.

After all construction is completed, including testing and flushing, the applicant or the member municipality shall submit a certified statement from a registered professional engineer that the work has been done under his supervision and has been completed in accordance with these Standards.

Permission will then be granted in writing by the District for connection to the District's system.

The connection shall be made as outlined in Section 1.4.

At the option of the applicant, leakage tests may also be conducted by using air instead of water provided the testing equipment, procedures and allowable leakage rates are first approved by the District.

3.2 Pumping Stations

1) Specifications

Detailed construction specifications shall be prepared by the applicant's professional engineer for both pumping unit supply and station construction.

Such specifications shall be specifically tailored to the pumping station and shall not be general in nature.

2) Testing

Pumping stations shall be tested as directed by the District using water. Each pump shall be tested through its operating range from shut off head to run out along with all control sequences and alarms.

REGIONAL DISTRICT OF NANAIMO

BYLAW NO. 500

SCHEDULE '4D'

TABLE 2

CONSTRUCTION - STANDARD TRENCH DETAIL

REGIONAL DISTRICT OF NANAIMO

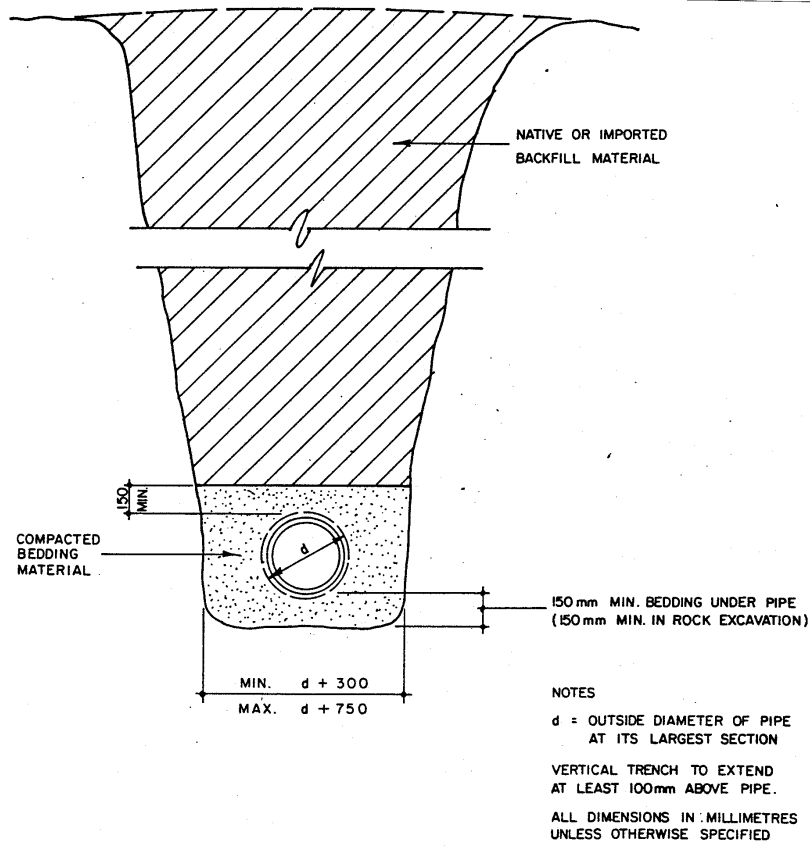

REGIONAL DISTRICT OF NANAIMO

BYLAW NO. 500

SCHEDULE '4D'

TABLE 3

CONSTRUCTION - STANDARD TRENCH DAM

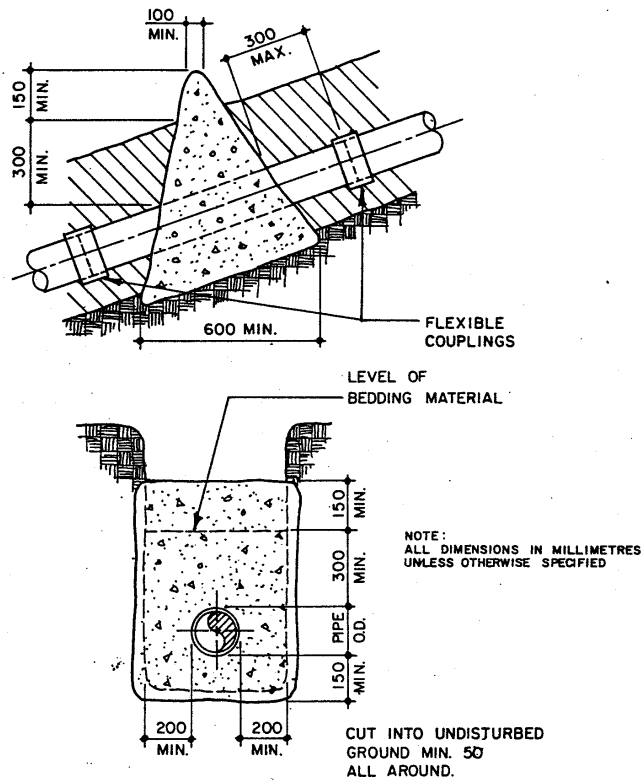

TRENCH DAM

CONSTRUCT TRENCH DAMS:

ON LATERALS HAVING 10% TO 14.9% SLOPE
NOT MORE THAN 30.0 m APART.

ON LATERALS HAVING OVER 15% SLOPE
NOT MORE THAN 15.0 m APART OR AS ESTABLISHED
IN THE FIELD BY THE ENGINEER.

ALL DIMENSIONS IN MILLIMETRES
UNLESS OTHERWISE NOTED

REGIONAL DISTRICT OF NANAIMO

BYLAW NO. 500

SCHEDULE '4D'

TABLE 4

CONSTRUCTION - STANDARD MANHOLE DETAILS

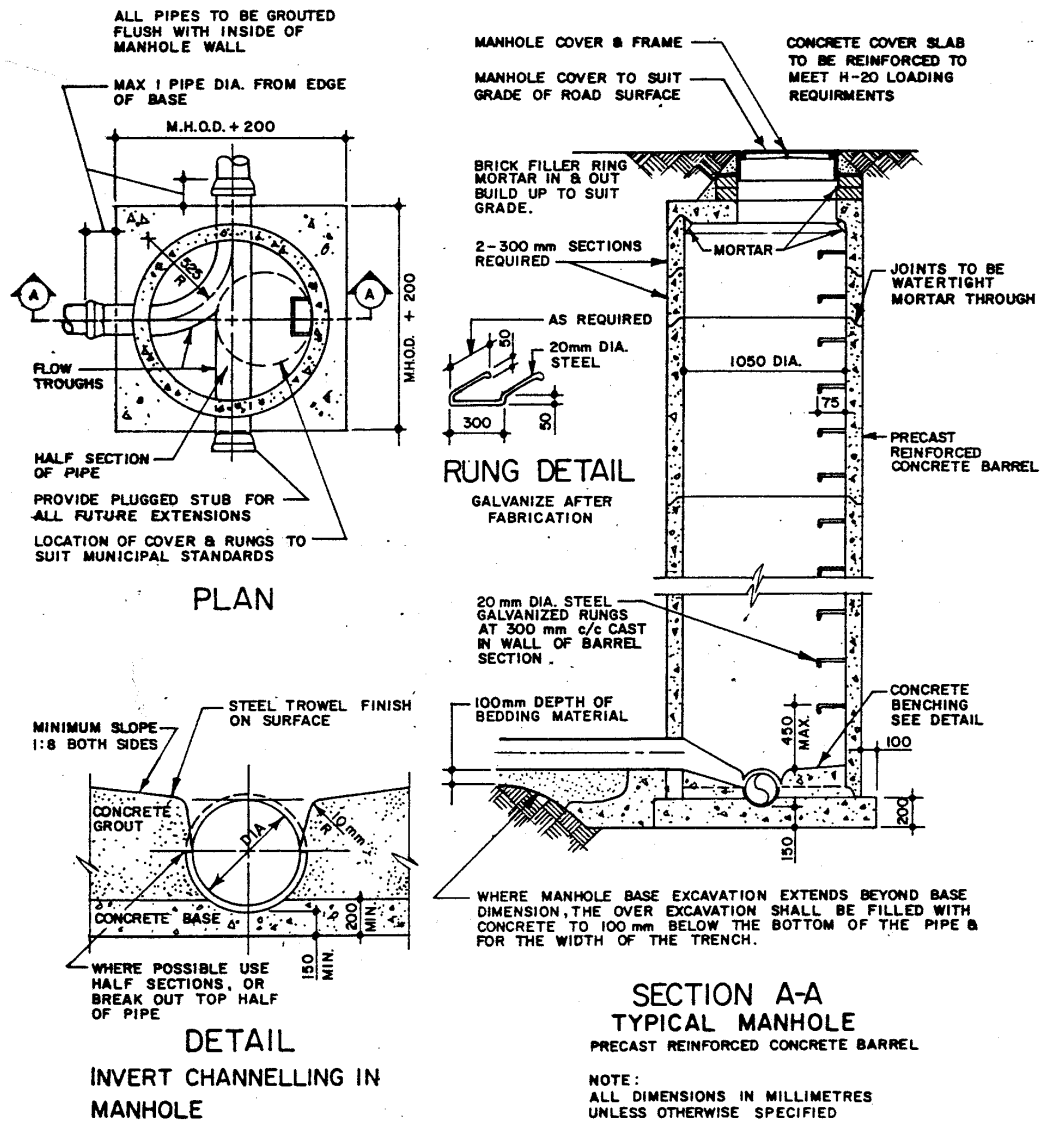

REGIONAL DISTRICT OF NANAIMO

BYLAW NO. 500

SCHEDULE '4D'

TABLE 5

CONSTRUCTION - STANDARD DROP MANHOLE DETAILS

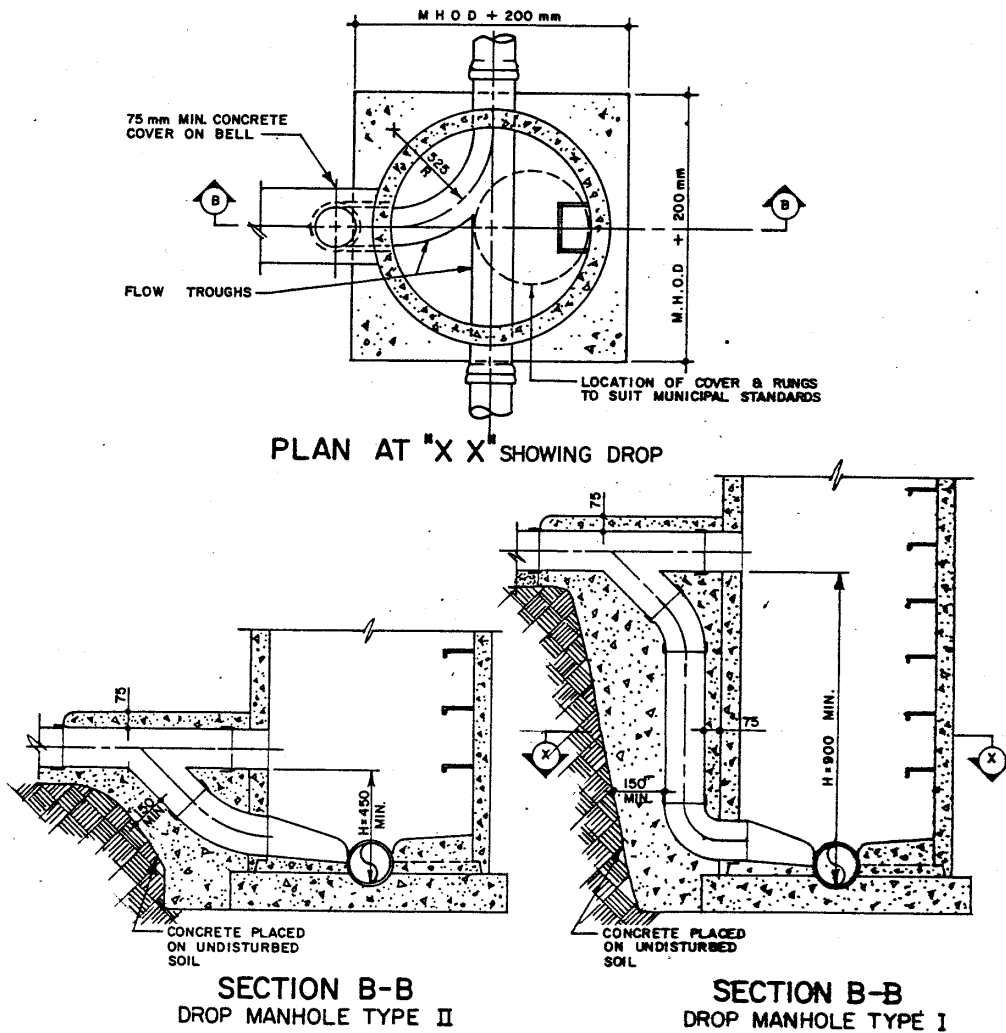

NOTE:
ALL DIMENSIONS IN MILLIMETRES
UNLESS OTHERWISE SPECIFIED

REGIONAL DISTRICT OF NANAIMO

BYLAW NO. 500

SCHEDULE '4D'

TABLE 6

CONSTRUCTION - STANDARD MANHOLE COVER DETAILS

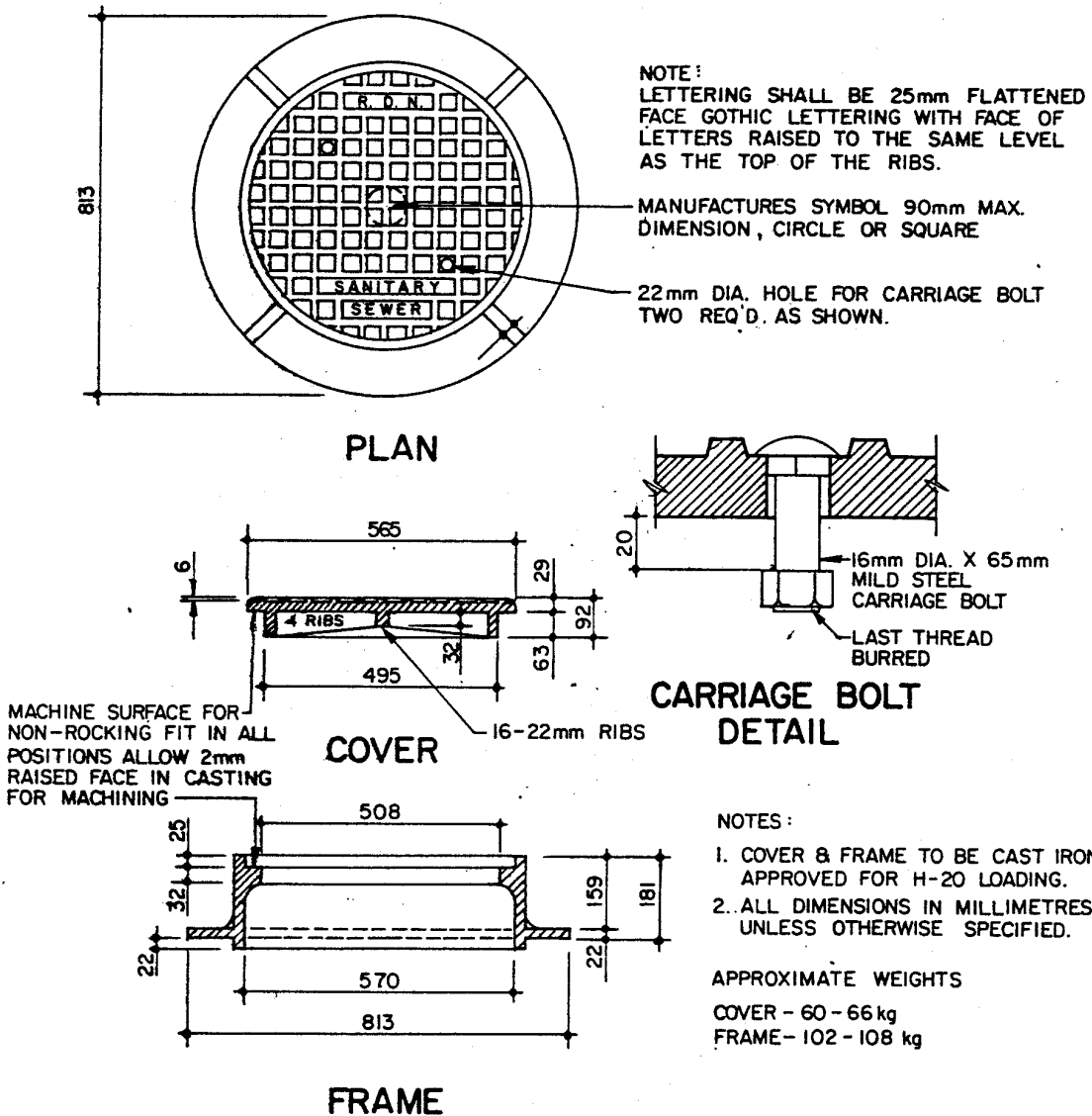

REGIONAL DISTRICT OF NANAIMO

BYLAW NO. 500

SCHEDULE '4D'

TABLE 7

CONSTRUCTION - STANDARD SERVICE CONNECTION

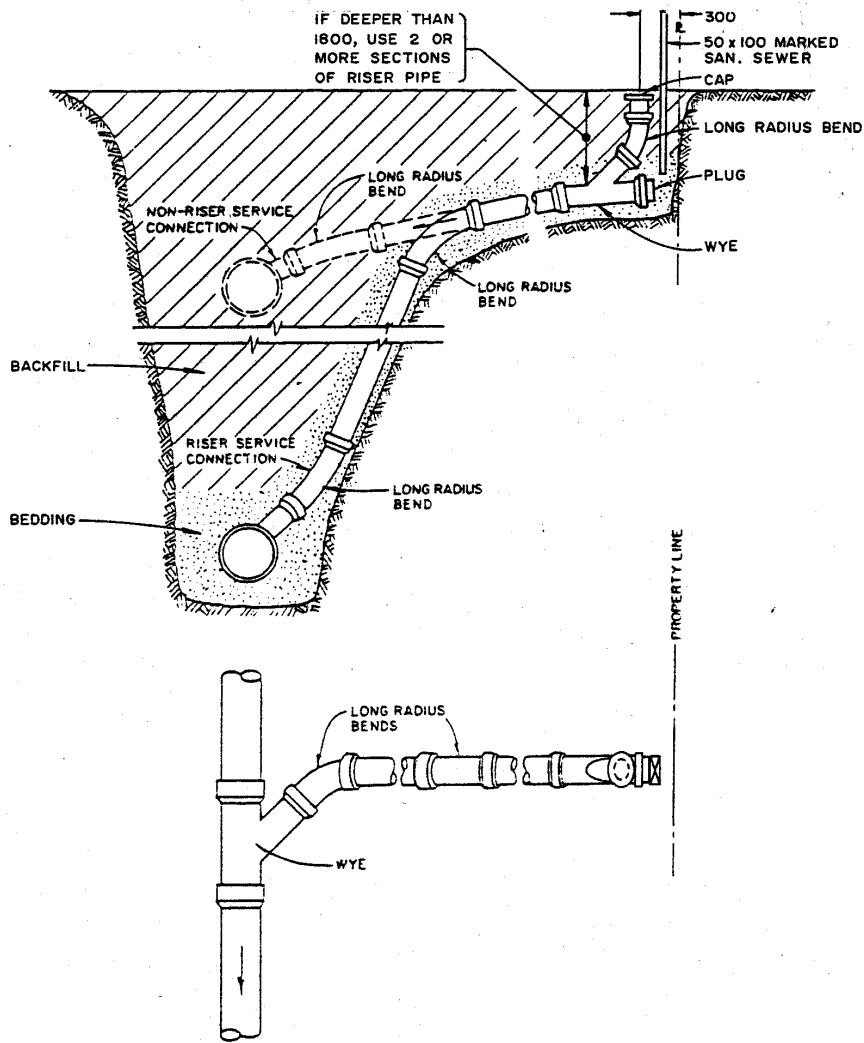

NOTE
ALL DIMENSIONS IN MILLIMETRES
UNLESS OTHERWISE SPECIFIED.

REGIONAL DISTRICT OF NANAIMO

BYLAW NO. 500

SCHEDULE 4D1¹

2013 LAKES DISTRICT AND SCHOONER COVE

COMMUNITY SEWER SYSTEM STANDARDS

¹ Bylaw No. 500.388, adopted July 22, 2014

REGIONAL DISTRICT OF NANAIMO
LAKES DISTRICT AND SCHOONER COVE
COMMUNITY SEWER SYSTEM STANDARDS

TABLE OF CONTENTS

1.	GENERAL.....	3
1.1	Requirement.....	3
1.2	Design.....	3
1.3	Definitions.....	3
1.4	Application.....	4
1.5	Drawings and Specifications.....	5
1.6	Variations from Standards.....	6
1.7	Permits.....	6
1.8	New Service Areas.....	6
1.9	Existing Service Areas.....	6
1.10	Inspection.....	7
2.	DESIGN.....	<i>Error! Bookmark not defined.</i>
2.1	Sewage Flows.....	<i>Error! Bookmark not defined.</i>
2.2	Design Population.....	6
2.3	Sewage Flow Calculation.....	8
2.4	Sewage Characteristics.....	8
2.5	Hydraulics.....	10
2.6	Piping.....	10
2.7	Pumping Stations.....	14
3.	CONSTRUCTION.....	18
3.1	General.....	18
3.2	Existing Structures and Utility Works.....	19
3.3	Clearing.....	21
3.4	Trench Alignment and Depth.....	21
3.5	Trench Backfill.....	22
3.6	Pipe Bedding.....	22
3.7	Repairs.....	24
3.8	Pipes and Fittings.....	24
3.9	Manholes.....	27
3.10	Service Boxes.....	29
3.11	Service Connections.....	29

4.	TESTING AND INSPECTION	30
4.1	Written Reports.....	30
4.2	Materials Testing	30
4.3	Leakage Testing of Gravity Sewers & Manholes	31
4.4	Cleaning and Flushing.....	34
4.5	Video Inspection of Sewer Mains.....	34
4.6	Inspection	35
5.	TRANSFERRING THE SEWER SYSTEM TO THE RDN.....	35
5.1	Final Inspection by RDN.....	35
5.2	Preparation/Execution of Transfer Agreement by Developer	36
5.3	Preparation/Execution of Maintenance Agreement.....	36
5.4	Preparation/Execution of Latecomer Agreement	36
5.5	Letter of Acceptance of the Works by RDN.....	36

APPENDICES

Appendix 1.....	Standard Drawings
Appendix 2.....	Letter of Assurance
Appendix 3	Certificate of Design
Appendix 4.....	Certification of Installed Works
Appendix 5	Stand by Irrevocable Letter of Credit

1. GENERAL

1.1 Requirement

The RDN will require a “Subdivision Servicing Agreement” to be completed for any new sewer system or existing system extension, unless otherwise agreed to in writing by the RDN.

Sewage collection and conveyance systems shall be designed, installed, extended, tested and maintained in accordance with the following regulations and standards.

The sewer standards for design and construction of the sewer within the Lakes District and the Schooner Cove Community Sewer Standards Area are to be governed by Regional District of Nanaimo Land Use and Subdivision Bylaw No. 500, 1987, and particularly by this Schedule 4D1.

It is the intention of the RDN to enter into a phased development agreement under section 905.1 of the *Local Government Act* with the property owner of the lands within the Lakes District Comprehensive Development Zone CD44 and the Schooner Cove Comprehensive Development CD45 that will specify changes to specified subdivision servicing bylaw provisions that would not apply to the development contemplated under that agreement, unless agreed to in writing by the developer.

1.2 Design

The engineering design of the sewage collection and conveyance systems shall be carried out by, and the preparation of drawings and specifications shall be sealed by a Professional Civil Engineer registered in the Province of British Columbia, and shall conform to these Standards.

1.3 Definitions

ADWF means average Dry Weather Flow

AWWF means average Wet Weather Flow

B.O.D means quantity of oxygen utilized in the biochemical oxidation of organic matter under standard laboratory procedure in 5 days at 20°C expressed in mg/l.

Collection facility means A facility used for the collection and conveyance of sanitary sewage.

Comminuted Garbage means the wastes from the preparation, cooking and dispensing of food that have been shredded to such a degree that all particles will be carried freely under the flow conditions normally prevailing in public sewers, with no particle greater than 6mm in any dimension

Design Flow means peak sewage flow plus peak storm water infiltration.

Direct Service Area means land and improvements directly served by the proposed facility.

Engineer means the Manager of Engineering Services for the Regional District of Nanaimo, or the person designated by the General Manager of Regional and Community Utilities.

Engineer of Record means a Professional Engineer registered with the Association of Professional Engineers and Geoscientists of BC who is responsible for the construction drawings and documents. The Engineer of Record will be the

engineer that signs and seals the record drawings and the certification of installed works.

Facilities means sewers, sewage treatment and disposal plants, pumping stations and other works necessary thereto, and outlets for carrying off, treating and disposing of sewage, and includes any and all works, structures, lands, conveniences, incidental to and necessary for a sewerage system.

Garbage means solid wastes from domestic and commercial preparation cooking and dispensing of food, and from the handling, storage and sale of produce.

Industrial Waste means liquid waste from industrial manufacturing processes trade or business, as distinct from sanitary sewage.

Lateral Sewer means sewer serving more than a single subdivided parcel

LPCPD means litres per capita per day

l/s means litres per second

mg/l means milligrams per litre

MPa means megapascals (1000 kPa)

Member Municipality or Member means a municipality or improvement district within the Regional District of Nanaimo.

M³/ha means cubic metres per hectare

M³pd means cubic metres per day

PDWF means Peak Dry Weather Flow

pH means the logarithm of the reciprocal of the weight of hydrogen ions in grams per litre of solution

ppm means parts per million

Peaking Factor (PF) means the Ratio of peak dry weather flow to the average dry weather flow.

Regional District means in this document the Regional District shall refer to the Regional District of Nanaimo.

Sanitary Sewage means sewage having a quality substantially equal to that of normal domestic sewage

Sanitary Sewer means a sewer which carries sewage and to which storm, surface and ground water are not intentionally admitted

Service Connection means a sewer connection a subdivided lot to the lateral sewer

Sewage Treatment Plant means an arrangement of structures and devices used for treating sewage

Stormwater Infiltration means the infiltration of groundwater or inflow of stormwater through leaks and connections into the system

Suspended Solids means solids that either float on the surface of, or are in suspension in water, sewage or other liquids, and which are removable by laboratory filtering

Tributary Area means all land in the service area tributary to the proposed facility

1.4 Application

All applications shall be made in the following steps:

1. Feasibility Review

All proposed construction of sewage collection and conveyance facilities shall be submitted to the Regional District for a feasibility review prior to commencement of any detailed design or construction. Such requests shall include a plan of the proposed construction and the area it will serve. The applicable feasibility review fee, in accordance with RDN Bylaw No. 1259.03 or most recent amendment, and the Letter of Assurance shall also be submitted at this time.

The Regional District will review the proposal, and reply in writing indicating the District's decision regarding acceptance or rejection, and/or the necessary amendments required.

2. Detailed Design

The detailed design and specifications shall be submitted in duplicate to the Regional District for Design Stage Approval (DSA) prior to construction. Attached to the submission shall be a Certification of Design. The applicable engineering review fee, in accordance with RDN Bylaw No. 1259.03 or most recent amendment, shall also be submitted at this time, along with the Design Professional Engineer's certified cost estimate for the works upon which the fee amount is based. *The final determination of the DSA fee shall be determined upon completion of the project and final certification of the construction costs by the Design Professional.*

The detailed plans will be returned either approved or with a request for re-submission. Re-submission will be carried out until the Regional District approves the detailed plans and specifications, and issues Design Stage Approval (DSA).

The designer shall submit the RDN approved plans to the Provincial Ministry of Transportation & Infrastructure and Vancouver Island Health Authority for approval permits. Receipt and submission of these permits to the RDN shall also be a prerequisite to the start of construction. Approval permits from other applicable agencies as required shall also be obtained.

1.5 Drawings and Specifications

All design drawings shall be ISO A1 size, 594 mm in depth and 841 mm in width the following information shall be supplied

- 1. Location Plan** - showing the location of the proposed work. This may appear on the same sheet as the Key Plan.
- 2. Key Plan** - showing a plan of the proposed work at a suitable scale such that the whole works are shown on one drawing, usually 1:5000, 1:2000 or 1:1000. The Key Plan shall show a general outline of the works, area covered and sheet numbers of the plan/profile drawings, and a legend showing existing and proposed works.
- 3. Plans/Profiles** - showing detailed design of the proposed works.

Plans shall be drawn at a scale of 1:500 or 1:250, showing the location of the pipe centre line, pipe size and type and off-set from property line, manholes, services, trench details, trench dam details and all related appurtenances in relation to road, easement and adjacent property and lot lines. Existing or proposed underground utilities are to be indicated on the plan in addition to the

extent of work required in making connection to existing sewer main. Location of service connections are to be shown. Connections not conforming to the standard offset require a distance from an iron pin or lot line.

Profiles shall be drawn at a horizontal scale of 1:500 and a vertical scale of 1:50 if more suited to specific conditions. The profile shall show the line of the existing and finished road grade on centreline, the invert of the pipe, location of manholes, and location of storm and water utilities. Where vertical curves are used, the invert elevation shall be shown at the beginning and end of the curves.

4. **Specifications** - shall be prepared to further define materials of construction and shall specify methods of construction and workmanship.
5. **Record Drawings** - shall be prepared by correcting drawings on completion of construction in order to reflect "record drawing" conditions for permanent records. The location of all individual lot sewer service connections shall be clearly shown with distance from the nearest manhole to the service wye. The drawings shall be signed and sealed by the Professional Civil Engineer, and shall be accompanied by a Certification of Installed Works. Final record drawings shall consist of:
 - (a) Two (2) full-size paper sets;
 - (b) One (1) full size 3 mil Mylar set;
 - (c) 2 – 11" X 17" paper sets or 2 A3 half-size paper sets, as agreed by the RDN; and
 - (d) Digital copies: one (1) as AutoCAD or Civil 3D file as applicable to the current software, and one (1) as TIFF files.

1.6 Variations from Standards

Where the applicant wishes to vary from these standards he shall submit a written request with adequate supporting data to the Regional District for review.

The Regional District shall make the final decision in writing as to the standard requirements which shall apply.

1.7 Permits

The applicant shall be responsible for obtaining all necessary approvals and permits required prior to commencing construction of the sewer system.

1.8 New Service Areas

Where a sewer system is to be constructed by an applicant within an area previously unserved by a community sewer system, the design and construction for the system shall comply with the requirements of these standards, unless otherwise agreed to in writing by the Regional District.

1.9 Existing Service Areas

Where a sewer system is to be constructed by an applicant within the existing or extended boundaries of an area already being served by a community sewer system, the design and construction of the system shall comply with the requirements of these standards.

1.10 Inspection

The Manager of Engineering Services of the Regional District or his appointed deputies shall be allowed access and provided adequate facilities for access to any part of the works at all times for the purpose of inspection.

Any connections to or interruption of any existing system will only be permitted be under the direct supervision of the Regional District. Adequate notice to the Regional District of any such interruption to service shall be provided in order that attendance by Regional District personnel can be arranged.

Any connections to or interruption of any existing system will be under the direct supervision of the Regional District. Adequate notice to the Regional District of any such interruption to service shall be provided in order that attendance by Regional District personnel can be arranged.

2 DESIGN

2.1 Sewage Flows

Sanitary sewer systems shall be designed using the following formula to accommodate peak sewage flows and peak inflow & infiltration.

$$AWWF = PDWF + I\&I$$

Storm water connections shall not be made to the sanitary sewer system.

2.2 Design Population

Design contributory populations shall be calculated in accordance with the Regional District of Nanaimo’s population predictions or with the ultimate planned development in the tributary area, whichever is greater. The following densities shall be used for housing types listed below:

Housing Unit	Persons per unit	Notes
Single Family / detached house	2.2	Based on 2011 census for Nanoose: 5674 persons / 2,587 housing units. Nanoose is predominately single family (>90% of dwellings)
Townhouse (attached, semi-detached) unit	1.9	Based on 2011 census for City of Nanaimo, City of Victoria
Apartment / condominium unit	1.4	Based on 2011 census for City of Nanaimo, City of Victoria
Secondary suite (carriage house)	1.1	50% of single family, consistent with draft zoning bylaw
Seniors living unit	1.1	Per CWPC Senior’s Housing Group

Where units are not known the following should be used:

.1	Dwelling unit	30 pph
----	---------------	--------

.2	Multi dwelling unit development	125 pph
.3	Commercial Equivalent of	50 pph
.4	Industrial Equivalent of	50 pph
.5	Institutional	50 pph

pph = persons per hectare

2.3 Sewage Flow Calculation

Average dry weather flow (ADWF) shall be established by multiplying the design population by an average daily sewage flow of 300 Litres per capita per day.

Peak dry weather flow (PDWF) shall be established by multiplying the ADWF by the peaking factor (PF) which obtained from the following formula.

$$PF=6.75*Population^{-0.11}$$

Peak dry weather flow can also be obtained using the graph contained in the standard drawing S-21.

For new developments, where water conservation measures are mandatory (such as low flow toilets), the sewage flow may be reduced by 10% from that obtained from this table.

Design sewage flows may be varied by the Regional District, where suitable metered flow record is available, or for developments utilizing wastewater (grey water) re-use onsite.

Peak inflow and infiltration (I&I) shall be calculated using:

- .1 12 m³/ha for Existing development areas
- .2 10 m³/ha for New development areas
- .3 The peak inflow and infiltration may be varied by the Regional District where suitable metered records for design storm events of maximum infiltration period of the year are available.

Design sewage rates of flow shall be computed by adding peak sewage flow to peak inflow and infiltration design allowances.

Sanitary sewage design calculations shall be prepared and submitted on a drawing showing the sanitary sewer tributary area as part of the detailed design drawings. If the sanitary sewer calculations are completed using modeling software the results of the software shall be displayed on the detailed design drawings. Use of modeling software shall be approved by the Regional District.

2.4 Sewage Characteristics

1. Sewage quality criteria shall be as follows:

Sewage Quantity (ADWF) in the Direct Service Area	Constituent	Average Normal
<50m ³ /day	BOD -5 day 20° C Suspended Solids pH Temperature	1000mg/l 800mg/l 4-10.5 79° C
50m ³ /day to 450 m ³ /day	BOD -5 day 20° C Suspended Solids pH Temperature	400mg/l 300mg/l 5-9.5 66° C
>450 m ³ /day	BOD -5 day 20° C Suspended Solids pH Temperature	200mg/l 200mg/l 5.5-9.0 54° C

2. Regulations governing the quality of wastes acceptable for admission to The Regional District of Nanaimo shall be followed and can be found in Bylaw 1225.
3. Where the existing industrial and/or commercial developments will be connected to the sewer system, the District may require that flow sampling be carried out to determine the design loadings; re-treatment of wastewater prior to discharge to the Regional District's facilities may be required.

2.5 Hydraulics

1. All facilities shall be designed to convey peak sewage flow plus peak I&I calculated as set out in section 2.3 sewage flow calculation.
2. Sewers shall be designed to carry the calculated design flow at a minimum velocity of 0.6 m/s.
3. When carrying design flow the maximum pipe depth of flow shall not exceed the following:

(a) <250mm	¾ pipe diameter
(b) 300mm to 450mm	¾ pipe diameter
(c) >500mm	Full pipe diameter
4. Service connections shall be designed with a minimum velocity of 0.9m/s.
5. Forcemains shall be designed with a minimum velocity of 0.6m/s.
6. Manning's Roughness Coefficient of 0.013 shall be used for design sewers and service connections. Manning's Roughness Coefficient of 0.015 shall be used for forcemains and outfalls.
7. Manholes shall be designed to incorporate a minimum elevation differential of 30mm wherever a horizontal deflection exceeding 45 degrees occurs and 5mm where it is straight run. These elevation differentials are in addition to the normal grade of the lateral sewer.
8. Pumping stations and treatment disposal works shall be designed to process peak sewage flow plus peak I&I calculated as set out in section sewage flows section of these standards. Bypassing of works to disposal shall not be allowed except under emergency conditions.

2.6 Piping

1. Lateral Sewers

No lateral sewer shall be less than 200mm in diameter, unless the sewer is the final section of a lateral that cannot be extended, in that case, under the approval of the RDN a pipe 150mm in diameter may be used providing that it meets the hydraulic needs of the sanitary sewer.

2. Service connections

Service connections shall be minimum 100mm in diameter. Service connections serving more than one dwelling unit shall be minimum 150mm in diameter or sized in accordance with design flows and available grades.

No service connection shall exceed 15m in length measured horizontally between the lateral sewer and the property line without the approval of the Regional District. If a service greater than 15m is approved by the Regional District, a cleanout facility must be provided as shown on the standard detail drawing for service connection.

Water service and sewer services in a common trench shall be in accordance with the requirements of the Vancouver Island Health Authority.

3. Depths

Depths of all sewers shall be such that all basements in the area the sewer is intended to serve can be drained by gravity. Lift stations from individual homes will be acceptable as depicted generally in the Lakes District Infrastructure Phasing Drawing appended to this addendum. There may be other areas that will be serviced by individual lift stations subject to the Approval of the RDN.

Minimum cover on services shall be 0.75m.

Where minimum cover cannot be provided, an explanation of the reasons shall be submitted to the RDN with the proposed method of protecting the pipe.

Excessively deep service inspection assemblies should be avoided. Where standpipes are more than 1.8m in depth, the standpipes shall be constructed in two or more sections, each having a length not exceeding 1.8m.

4. Curved Sewers

Wherever possible, curved alignment shall be avoided.

Horizontal curves may be permitted where the configuration of the right of way permits curvature at a constant offset, where the velocity in the pipe exceeds 1m/s and where grades of 1% or greater are available. Tracer wire is required on all sewers with horizontal curves.

Vertical curves may be permitted where excessive depths or rock cuts are to be avoided or energy dissipation is needed.

Radius of curvature for PVC sewers to 250mm diameter shall be uniform throughout the curves by bending pipe barrel plus joint deflection to 2 degrees maximum and shall not be less than 60m or the manufacturer's minimum pipe radius, whichever provides a greater radius of curvature. PVC pipes 300mm diameter shall be deflected only at pipe joints to 2.5 degrees maximum, and 350mm diameter and larger pipes at pipe joints to 1.5 degree maximum. Miter bends are not to be used unless approved by the RDN.

Horizontal curves will be permitted for the gravity sewer along the eastern side of Enos Lake and in the park areas where sewers are approved. Curves radii are to be at or larger than manufacturers specifications. Vertical grades are to be chosen such that velocities must be equal to or exceed 1m/s (for max day flows at full build out).

Compound horizontal curves are not permitted between manholes.

Horizontal and vertical may be permitted in the same run.

Concrete pipe shall not be curved horizontally or vertically.

5. Manholes

In general the distance between manholes shall not exceed 150m, unless approved by the RDN. If approved by the RDN the maximum distance between manholes may be increased to 250m.

Manholes shall be located at grade and alignment changes, at lateral size changes, at the upstream end of all lateral sewers, at the junctions of all lateral, at regular spacing not exceeding the maximum allowable, sewers and at service connections larger than 150mm in size.

Cleanouts may be substituted for manholes at the upstream end of lateral sewers where no further extension of the sewer main is anticipated.

Where the difference between the incoming and outgoing invert exceeds 600mm, a drop manhole shall be used. See the standard detail drawings for drop manhole details. Differences between 150mm and 600mm should be avoided. Inside drop manholes with a minimum barrel size of 1200mm as shown in drawing the standard detail drawings, may be permitted for new construction of drops between 900mm and 2000mm and upon the approval of the RDN.

Manholes shall be constructed in a manner that prevents water from infiltrating into the manhole.

Where cast in place manholes are proposed, an explanation of the reasons shall be submitted to the RDN with the proposed design and construction method. Only ready mix concrete, 20 Mpa at 28 days shall be used.

Manholes shall be located so that the manhole covers are not located in the wheel paths of vehicles, in gutter lines, curbs or sidewalks.

Manholes located in untraveled areas shall have a 1m asphalt apron which slopes away from the manhole rims at 2%.

A watertight manhole frame and cover shall be required for all sewer manholes located in areas which flooding can occur.

Precast manhole bases shall be sized according to the following table

Pipe Size (mm) (Nominal)	Depth of Manhole (m) (Top of Cover to Inv.)	Barrel Size (mm) (Inside Diameter)
150-375	0 - 5.9	1050
150-375	6-9	1200
150-600	9 or deeper	1500
400-600	0-8.9	1200
675 – 1050	All depths	1500

6. Manhole Platforms

Manhole platforms are generally not required. Design of manholes shall consider use of appropriate safety equipment.

A cage, well or ladder safety device shall be provided where the length of climb is greater than 6 metres.

If platforms are necessary, ladders shall meet the following requirements:

- (a) The ladder shall consist of multiple sections.
- (b) Each section shall be horizontally offset from adjacent sections.
- (c) A landing platform shall be provided within the length of climb.
- (d) Refer to the Standard Drawings for manhole platform details.

7. Location of Sewers

Wherever possible, sewers shall be located on the high side of the street where only the high side is served by the lateral and on the low side of the street where both sides are served by the lateral. Wherever possible the sewer shall be located on the opposite side from the watermain and at a constant offset from the property line or paved roadway.

Sanitary lateral sewers shall be located at least 3.0m horizontally and 0.45m vertically from water pipes unless approved by the Vancouver Island Health Authority and all joints are suitably coated and wrapped.

Sanitary sewer mains may be installed in a common trench with storm sewers provided the minimum outside pipe separation is 300mm.

8. Utilities in Private Lands

The design of utilities shall avoid crossing private lands as much as possible.

Utilities crossing private lands shall generally be offset a minimum 1.5 metres from the property boundary unless otherwise approved by the Regional District.

Appurtenances such as manholes, valves ect. shall not be located on property boundaries.

Utilities shall not cross private lands in such a manner that they render the property unusable and generally be located beyond the normal building envelope allowed by zoning. Special considerations must be given to ensure the location of the utility crossing minimizes the limitation on the future use of the property.

The minimum width of the right of way shall be 3m for single pipes and 4.5m for two pipes installed in a common trench.

9. Siphons

Where a siphon (i.e. inverted sewer, depressed sewer) is required to carry flow under an obstruction such as a stream, the following criteria shall be applied to the design:

- (a) All siphons shall be multiple pipe structures.
- (b) A cleansing velocity of 0.6 to 0.9 m/s shall be reached at least once a day in the primary pipe even during the first years of operation.
- (c) The total system shall be sized to accommodate the ultimate design peak flow.
- (d) A 1200mm diameter manhole shall be provided on both ends of the siphon.
- (e) Each manhole on the siphon shall be provided on both ends of the siphon.
- (f) There shall be no high points in the siphon between manholes.
- (g) There shall be no acute bends in the siphon.
- (h) There shall be no change of pipe diameter between manholes.
- (i) The primary pipe shall be minimum 200mm in diameter wherever possible.
- (j) All siphons shall have a separate debris sump manhole upstream of the siphon. The debris sump shall be designed to allow easy access for maintenance and cleaning and shall be suitably vented.

2.7 Pumping Stations

This section applies to all municipal owned and operated sanitary sewer pumping stations. Properties serviced by individual sewer pumps shall be connected to the municipal sewer system by a gravity service connection from the property line to the municipal sewer system.

This section is intended as a guide for general requirements for a pumping station. All pumping station designs shall be developed using good engineering practice with the input of the Regional District of Nanaimo.

Sanitary sewer pump stations shall only be permitted at locations where gravity connections from an existing or proposed trunk sewer cannot be provided.

1. General Design Criteria

Pump station size and configuration shall accommodate ultimate sewage flows.

Pumping stations shall be designed and constructed using materials recognized for quality in the sanitary sewer industry.

Pumping stations shall be fully automatic in normal operation, and fully compatible with the Regional District of Nanaimo's telemetry system. Specifics of SCADA systems shall be coordinated with the Regional District of Nanaimo during the pre-design stage.

All stations shall have a wet well capacity providing not more than 12 hours of storage at minimum design flows and a frequency of pump start –up of not less than 5 minutes at peak flows.

No overflow of sewage shall be permitted. Pumping stations shall have emergency backup systems to prevent sewage overflows during a mechanical or electrical failure.

4 complete (3 paper and 1 digital) sets of operational instructions, maintenance manuals, emergency procedures, parts lists, as-built engineering drawings, shall be submitted to the Regional District of Nanaimo upon completion of the pump station.

Current and future service requirements shall be evaluated with the electrical and phone utility companies.

Buildings shall have gutters on all four sides of the roof.

Pump station buildings shall be BC Hydro green in colour.

2. Pumps and Equipment

As a minimum, pumping stations shall be equipped with alternating duplex pumping units. One pump shall be equipped with a flush valve.

Duplex pump arrangements shall be designed for each pump providing 100 percent standby at peak flow.

Individual pump motors shall be equipped with hour meters and pump run indicator lights.

All pumping units to be grinder or vortex pumps capable of handling a 75mm solid, without clogging.

All piping and valves shall have a minimum of 100mm diameter.

Minimum pump run time shall not be less than 2.5 minutes or as recommended by pump manufacturer; whichever is greater.

Each sewer pump shall be provided with its own individual pipe connection to the wet well.

A concentric increaser shall be provided on the pump discharge followed by a check and gate valve.

Check valves on discharge lines shall be ball type.

The desirable velocity at the discharge point at maximum pump discharge is from 1.8 to 2.5 metres per second.

3. Controls

Stations shall be equipped with high and low level alarm, security alarm, power fail alarm and general alarm (for motor overload, temperature, and moisture alarms if so equipped.) Also, a level transducer probe and data logger, suitable to the Regional District, shall be installed in the wet well.

Manual operation of all pumps by push-button control shall be possible for checking the operation and for drawing down the wet well. Manual operation shall bypass the low water cutout but not the low water alarm.

Wiring for the control panel shall be underground from the hydro pole to the control panel kiosk.

Alarms shall have audio & visual alerts at the pumpstation.

Stations with submersible pumps shall have the motor starters and controls located in a factory assembled free-standing unit control centre located at ground level on a concrete pad.

Stations with non-submersible pumps, shall have the pump motors and controls located in a ventilated, heated, lighted and dehumidified area.

Name plates, approved by the Regional District, shall be supplied on the pump's control enclosure components and other operating components to indicate to the operator the purpose of the component or the operating routine applying to the component.

An isolation switch for each pump shall be located within sight of a service man working inside. Switches shall function by breaking the pump control circuit, thereby isolating the main power at the control panel.

Relays are to be used in conjunction with level controls.

An electrical panel heater and thermostat shall be installed inside all control panels.

The control panel kiosk shall be aluminum.

The control panel shall include an extra 110 volt, 10 amp, duplex receptacle, complete with cover, for operation of small electric tools. It shall be separately fused within the control panel.

4. Standby Power

The onsite provision of a standby power generator will be decided on a site specific basis by the Regional District . If the Regional District decides that permanent standby power facilities are not needed for the specific pump station, the pump station shall be equipped with a generator receptacle matching the Regional District style.

5. Pumping Station Chamber

The control panel and non-submersible pump motors shall be located in one above-ground enclosure unless otherwise approved by the Regional District.

The below grade chamber shall be reinforced concrete construction or as approved by the Regional District.

Concrete pump chambers shall have a 1 to 1 slope benching around the base perimeter.

Exterior concrete walls shall be tar-coated to prevent leakage.

The chamber above grade shall be designed to harmonize with the surroundings, shall be of fireproof construction and have no windows.

Chamber access shall be in accordance with the latest WorkSafe BC Regulations.

Equipment guards and rails for floor openings shall be provided.

Independent mechanical ventilation shall be provided by explosion proof exhaust fans for the dry and wet chambers where applicable. If the ventilation system is intermittent rather than continuous, the electrical switches shall be interconnected with the station lighting system. Ventilation interconnected with the station lighting system shall have sufficient capacity to exchange the total volume of air inside the station with fresh air within 3 minutes. All vents lines shall have screened openings to prevent the entrance of rock or other foreign matter. Air flow in fans shall be fresh air to wet well with second vent out for discharge.

Dry well stations shall include a sump and sump pump for the interior of the dry well with discharge above the top water line in the wet well.

The entrance to the station shall be waterproof and supplied with a lockable door complete with security alarm.

Where the entire station is underground, the entrance shall not be more than one metre above the surrounding finished grade.

6. Sitework and Lighting

A 25mm water service connection, complete with an approved backflow prevention device, shall be provided in the station designed in accordance with the AWWA Cross-Connection Control Manual.

The pumping station and appurtenances shall be within a porous paved surface or approved gravel which provides for the turning movements. A minimum turning grade of 12.8 metres, shall be used to determine turning movements. A minimum of 3.65 metres in width is required for access to all equipment. Approved landscape screening shall be provided.

Storm drainage from the site shall be self-contained.

Adequate protection shall be provided to prevent vandalism and vehicular damage and to protect public safety. Requirements may include fencing, non-mountable curbs and/or traffic bollards.

High pressure sodium, dark sky compliant, lighting shall be provided unless other wise approved by the Regional District. Backup lighting connected to the standby power supply shall be provided in case of a power failure.

7. Forcemains

All forcemains shall be designed so that the minimum velocity is 0.6m/s and a detention time not exceeding 12 hours during ADWF.

Forcemains shall be designed without high points unless otherwise approved by the RDN. If approved, an air-relief valve shall be provided at high points in the line, meeting RDN requirements.

Thrust blocks shall be provided at all bends as required.

Cleanouts (blowdowns) shall be supplied at all low points of force main.

Flushouts shall be located at the terminus end of all pressure sewer mains leading to manholes or pump stations.

3. CONSTRUCTION

3.1. General

1. Access Roads

Temporary roads shall be constructed as required for access to the working areas. Adequate drainage facilities in the form of ditches, culverts, or other conduits shall be installed as found necessary to maintain these roads. In the construction of access roads, existing drainage facilities, natural or otherwise, shall not be disturbed to the detriment of properties outside the working area and such facilities shall, unless otherwise provided elsewhere in the specifications, be restored to their original condition on completion of the work.

2. Sanitary Facilities

Clean, sanitary latrine accommodations shall be provided and shall be located and maintained in accordance with the regulations of VIHA.

3. Special Tools, Operating Manuals, Shop Drawings

With each piece of mechanical and electrical equipment or machinery having wearing parts and requiring periodical repair and adjustment, all special tools, wrenches, and accessories required for removing worn part, making adjustments, and carrying out maintenance shall be supplied. All gauges, indicators, and lubricating devices necessary for the proper operation of the equipment shall be furnished.

With each piece of equipment, 4 sets of operating manuals and as-constructed shop drawings shall be supplied. The manuals shall provide the manufacturer's recommended maintenance schedules with the grades of lubricants required, and instructions as to how the equipment may be taken apart for periodical inspection and replacement.

4. Blasting

Blasting will be permitted only after securing the approval of the applicable authorities. Blasting will not be carried out without first verifying that insurance covers any loss of life or damage that may result from this work. The Regional District, in granting approval for blasting, does not in any way assume responsibility for injury, loss of life, or damage that result there from, and such approval shall not be construed as approval of the methods employed in blasting, the sole responsibility therefore being that of the applicant.

5. Site Maintenance and Clean Up

The working area shall be maintained in an orderly manner and shall not be encumbered with equipment, materials, or debris.

Clean up shall be a continuing process from the start of the work to final acceptance of the project. Property on which work is in progress shall at all times be kept free from accumulations of waste materials or rubbish. Accumulations of waste materials, which might constitute a fire hazard, shall not be permitted. Spillage from hauling vehicles on traveled public or private roads shall be promptly cleaned up. On completion of construction, all temporary structures, rubbish, and waste materials resulting from the operations, shall be removed.

6. Erosion and Sediment Control

An Erosion and Sediment Control Plan shall be submitted for review and approval seven days prior to the pre-construction meeting. The Erosion and Sediment Control Plan shall describe the proposed methodology to minimize potential impact on the surrounding environment. The Erosion and Sediment Control Plan shall indicate how the Contractor plans to control sediment discharges from the project and what measures will be put in place to prevent damage to aquatic habitat located downstream.

The work shall be carried in compliance with the submitted and approved Erosion and Sediment Control Plan and all other environmental laws affecting the work and with the recommendations contained in the most recent edition of the "Land and Development guidelines for the Protection of Aquatic Habitat" published jointly by the Ministry of Land, Water, and Air Protection and Fisheries and Oceans Canada.

For the erosion and sediment control plan, 'environmental laws' means all statutes, regulations, orders, and bylaws relating in any way to the natural environment or its ecosystems, public or occupational health, transportation, storage or handling of contaminants or hazardous materials.

3.2 Existing Structures and Utility Works

1. Scope

Existing structures shall be interpreted as being all existing pipes, ducts, ditches, or other works forming a part of sewerage, drainage, water, telephone, electrical, gas, or other utility system, as well as sidewalks, curbs, poles, fences, buildings, and other man-made things that may be encountered during construction.

2. Material Supply

Unless otherwise specified, materials supplied for replacement of existing structures shall be at least equal to those being replaced.

3. Location of Structures

Drawings or descriptions, verbal or otherwise, of existing structures or their location that are supplied by the Regional District are intended only as an aid to locating these structures. Measurements and location of the existing underground structures shown on the drawings are not guaranteed to be accurate, and must be verified prior to proceeding with construction.

4. Protection of Structures

Unless authorization from the Regional District is received for their removal, underground and surface structures encountered during construction shall be protected from damage. In the event of damage resulting from the construction operation, structures shall be repaired or replaced to a condition, which is at least the equivalent of that which existed prior to construction.

5. Emergency Situations

In emergency situations resulting from the construction operation, where life or property are endangered, the applicant shall immediately take whatever action is possible to eliminate the danger, and shall also notify the Regional District of the situation.

6. Access Maintained

Existing hydrants, valves or control pit covers, valve boxes, curb stop boxes, fire or police call boxes, and all other utility controls, warning systems, and appurtenances thereof shall not be made inaccessible at any time by the construction work. Bridges, walks, or other temporary facilities shall be provided as may be necessary to ensure that these controls or warning systems are free for use in their normal manner at all times during construction.

7. Curtailment of Utility Service

Where existing utilities such as water, sewer, electricity, telephone, and gas are serving the public, work shall be planned and executed such that there is no curtailment of service provided by these utilities without prior receipt of approval of the authorities responsible for provision and maintenance of these utilities. The applicant shall obtain the above approvals from the recognized authorities controlling these utilities. If approval for such disruption of utility service is not granted, it may be possible to establish temporary facilities to provide continuous utility service during the course of construction. Such temporary facilities shall only be implemented after receiving the approval of the utility authority.

If approval is received to temporarily shut off an existing utility, individual users of the utility shall be notified at least one hour prior to the time of shut-off.

8. Support of Structures

Existing structures shall be protected against damage from settlement by means of timber support or compaction of backfill as required. Where necessary, timber support shall remain in place following backfill of excavations.

Backfill which is placed under or adjacent to the existing structures, which have been undermined during excavation, shall be compacted in a manner which will

prevent damage of the structure from settlement. Such backfill shall be of approved granular material suitable for compaction.

On existing piping, this material shall extend horizontally a minimum distance of 600 mm on both sides of the pipe at a level 300 mm above the pipe, and shall slope down from this point at 1-1/2 horizontal to 1 vertical to meet the bottom of the excavation.

9. Drainage Facilities

Existing culverts, enclosed drains, flumes and ditches, and other drainage structures affected by the work but left in place shall be kept clear of excavated material at all times during construction. When it is necessary to temporarily remove an existing drainage structure, suitable temporary ditches or other approved means of handling the drainage shall be provided during construction.

3.3 Clearing

Prior to clearing, the exact limits of the areas on which clearing may take place and whether or not there are restrictions placed on clearing which would result in leaving certain trees, structures, or other existing items in place shall be ascertained.

Prior to trenching, the right-of-way shall be cleared of all standing or fallen brush, timber, stumps, or other debris, which may obstruct the construction operation, damage the completed installation, or detract from the appearance of the site on completion of construction. This material shall be burned or otherwise disposed of to the satisfaction of the Regional District.

The restrictions of all authorities established to control burning in the area shall be complied with. If burning cannot be done on the clearing site, the material shall be hauled to an approved location for burning or disposal. Burning permits, as required, shall be obtained by the applicant.

3.4 Trench Alignment and Depth

Following clearing and prior to excavation of the trench, the location at which the pipe shall be installed shall be established by setting appropriate survey control. As a minimum this shall include marking of the manholes and any horizontal or vertical curves in the pipe, with suitable elevation data provided. A laser should typically be used to maintain grade during pipelaying, and for all grades of 2% or less.

Where pipe is to be installed to a predetermined grade, a cut sheet will be provided showing the depth of the pipe invert relative to the grade stake elevation at the respective locations along the pipeline.

The trench shall be excavated so that pipe can be laid to the established alignment and depth, with allowance made for specified trench wall clearances and bedding as shown in the standard drawings of this Schedule for various conditions, or otherwise required.

All trenching and excavations shall be carried out in the manner recommended by the Workers' Compensation Board of British Columbia, or as may be necessary to protect life, property, and structures adjacent to the work and the work itself.

3.5 Trench Backfill

Trench backfill shall be carried out as shown in the standard drawings of this Schedule for various conditions.

3.6 Pipe Bedding

1. Granular material for pipe bedding within the pipe zone shall be sand or clean gravel or crushed rock, evenly graded from coarse to fine, and conforming the following specifications and gradations limits:
2. The standard trench section is shown in the standard drawings of this Schedule for various conditions. The nominal minimum depth of cover shall be 1.5 m in traveled areas and 1.0 m in untraveled areas unless otherwise permitted by the Regional District. Water mains shall be located not less than 3 m centre-to-centre from all sanitary lines, unless otherwise permitted by the Regional District and the Vancouver Island Health Authority.
3. Bedding material shall conform to the following gradation limits:

Gradation Limits
(Percent by Weight Passing)

Sieve Designation Type 1 Type 2

19.0 mm	100	90-100
12.5 mm		65-85
9.5 mm	85-100	50-75
4.750 mm	70-100	25-50
2.36 mm		10-35
1.18 mm	20-65	
0.850 mm		5-20
0.6 mm	0-45	
0.425 mm		0-15
0.18 mm		0-8
0.15 mm	0-10	
0.075 mm	0-5	0-5

4. Type 1 is the standard acceptable bedding material. Type 2 shall be used where specified by the design engineer to meet special design loading. Dry sieve analysis shall be carried out in checking material gradation.
5. Other acceptable bedding materials, for use only where shown on the construction drawings or as approved by the Engineer, are drain rock, pea gravel or native material. In rock, pipe zone shall have filter fabric between rock and bedding material. Filter fabric shall be non-woven, minimum grade Armtex 200 or equivalent.
6. The bedding material shall cover the full width of the trench bottom and have a minimum depth of 100 mm on completion of compaction. In rock excavation the minimum depth of bedding below the pipe shall be 150 mm after completion of compaction.
7. Bedding material shall be compacted in maximum 150 mm lifts to 95% of Modified Proctor Density (ASTM D1557). Side tamping shall be carried out with bedding material placed to the pipe springline, to provide haunch support.

8. Bedding material shall be placed in such a manner that the pipe is evenly supported throughout its length by the pipe bedding material.
9. Placement and compaction of the bedding material shall not damage or displace the pipe.
10. Bedding material shall be leveled across the full width of the trench to an elevation of 300 mm above the crown of the pipe.

3.7 Repairs

Any system approved and built to these standards which requires maintenance work, shall be repaired with materials and construction methods conforming to the specifications contained herein.

3.8 Pipes and Fittings

The size and type of the pipe to be used are to be shown on the design drawings.

Only the pipe types listed in this section shall be used for lateral sanitary sewers or services.

Pipe shall be installed in strict accordance with all of the manufacturer's recommended practice.

All products used shall conform to the Regional District of Nanaimo's Approved Product List.

1. Polyvinyl Chloride (PVC) Pipe, Lateral Sewers

- (a) PVC pipe shall be DR 35.
- (b) Pipe and fittings shall be manufactured to the following standards:
 - 100mm to 375mm ASTM D3034 and CSA B182.2
 - 450mm to 675mm ASTM F679 and CSA B182.2
- (c) All PVC sanitary gravity main pipes should be green in colour.
- (d) Sanitary sewer main pipe, fittings and service connections shall be joined with a rubber gasket or other preformed, factory manufactured gasket or approved material designed for use with the specified pipe. Solvent connected joints and fittings will not be permitted.

2. Polyvinyl Chloride (PVC) Pipe, Service Pipes & Fittings

- (a) PVC pipe of 100 mm pipe diameter shall be DR 28.
- (b) Services larger than 100mm shall be as specified the same as lateral sewers.
- (c) All sanitary services 100mm in diameter shall be white.
- (d) Service connections to be PVC mainline pipe shall be made with PVC fittings manufactured to ASTM D3034, CSA 182.1 and CSA 182.2.
- (e) The use of saddles instead of manufactured wye fittings shall require approval of the RDN.

3. Polyvinyl Chloride (PVC) Pipe, Pressure Pipe

- (a) Pipe shall be white in colour.
- (b) Pipe and fittings shall be manufactured to the following standards:
 - 100mm to 300mm AWWA C900 and CSA B137.3
 - 350mm to 900mm AWWA C905 and CSA B137.3
- (c) Pipe shall be compatible with mechanical and push-on joint fittings and valves without the use of special adapters.
- (d) Pipe shall include push-on integrally thickened bell and spigot type joints conforming to ASTM D313.9 with single elastomeric gasket conforming to ASTM F477.

4. High Density Polyethylene (HDPE) Pipe (Smooth Profile)

- (a) Pipe shall conform to CGSB 41-GP-25M. Pipe material shall conform to ASTM D1248 Type III, Class C, Category 5, Grade PE 35-10
- (b) Minimum Acceptable pipe class shall be DR 26 with a hydrostatic design stress of 10MPa.
- (c) HDPE pipe used for pressurised applications shall be a minimum pipe class of DR21.
- (d) All pipe shall bear the pipe series designation and manufacturers name.
- (e) Fittings for HDPE, if required, shall be detailed and manufactured by the pipe manufacturer. Mitre bends shall be fibreglass reinforced. Fittings shall have a pressure rating at least equal to that of the pipe it is being joined.
- (f) Pipe may be deflected up to the manufacturer's recommended minimum radius. Deflected pipe may be used instead of manufactured or mitred bends.
- (g) Joints shall be by thermal butt-fusion and constructed in accordance with the manufacturers specifications.
- (h) Flange joints shall be used to join long sections of butt joined pipe or as shown on the design drawings.
- (i) Flanges for HDPE pipe shall be slip-on type installed in conjunction with stub ends supplied by the pipe manufacturer. The flanges shall be class 150 meeting ANSI B16.5 drilling dimensions. Flanges shall be carbon steel.
- (j) All flanged joints shall be separated by a neoprene gasket bonded to one of the flange faces. Neoprene for flange gaskets shall be 3mm thick with holes drilled for flange bolts and size equal to flange diameter.
- (k) Bolts and nuts for flanges shall be hot dipped galvanized.
- (l) HDPE pipe shall only be used where approved by the RDN.

5. Concrete Pipes

- (a) Concrete pipe should only be used for sewer mains larger than 450mm in diameter.
- (b) Concrete pipe should be reinforced, ASTM C 76 Specification.
- (c) Lifting holes in concrete pipe shall be plugged with prefabricated plugs in non-shrink grout or other plugs recommended by the pipe manufacturer.
- (d) Concrete pipes shall have every joint grouted.
- (e) Testing for concrete pipes shall be carried out hydraulically. Air testing will not be permitted.

6. Ductile Iron Pipes (DI)

- (a) Ductile iron pipe may be used with the specific approval of the Regional District.
- (b) Soil corrosion survey will be required, and suitable corrosion protection measures installed.
- (c) Testing for ductile iron pipes shall be carried out hydraulically. Air testing will not be permitted.

3.9 Manholes

1. Manhole Sections

- (a) Unless otherwise approved, all manhole sections shall be precast reinforced concrete in accordance with ASTM C478.
- (b) All precast sections shall be complete with ladder rungs as the manhole steps section listed below.
- (c) O-ring rubber gaskets shall be placed between Manhole sections. The O-ring rubber gaskets shall conform to ASTM C443.
- (d) The inside surface of the precast barrel at the O-ring joints shall be filled with cement grout to a smooth finish.
- (e) Precast manhole barrel sections shall be placed plumb.

2. Manhole Bases

- (a) All manhole bases are to be precast unless otherwise approved.
- (b) Manholes bases shall be constructed so that the first section of a precast base can be set plumb with a uniform bearing pressure throughout its circumference.
- (c) Precast manhole bases shall be placed on 150mm thick base of 40mm drain rock.
- (d) Precast manholes and Cast-in-place manhole bases shall conform to the applicable standard drawings.
- (e) Cast in place manholes or connections to existing manholes shall utilize a rubber adaptor ring to seal the connection.

- (f) If the material at the bottom of the trench is unsuitable for support, the bottom shall be over excavated to a firm base, and backfilled with **base gravel and thoroughly compacted**.

3. Manhole Tops

Manhole tops shall be flat slab, precast concrete. Tops shall be reinforced to meet H20 loading conditions. Precast tops shall conform to ASTM C478 with approved offset opening for frame and cover.

4. Manhole Covers and Frames

- (a) Covers and frames shall be cast iron and certified to meet H20 loading requirements.
- (b) Covers and frames shall conform to the standard drawings.
- (c) Covers shall have “RDN SANITARY SEWER” permanently embossed on the cover.
- (d) Utility chamber manhole frame and cover shall conform to the standard drawings.
- (e) A watertight manhole frame and cover, if required shall conform to the standard drawings.

- (f) Covers located in statutory rights-of-way shall be permanently embossed with the additional wording “DO NOT COVER”.
- (g) Frames shall be set on precast concrete grade rings to bring the cast iron manhole frame to grade as shown on the drawings.
- (h) In unpaved areas, covers shall have a 1m circular 50mm thick asphalt apron sloping away from the manhole cover at a minimum grade of 2%.
- (i) In paved areas covers shall not protrude above the finished pavement.
- (j) In streets manhole covers shall not be placed in the wheel paths of vehicles.

5. Manhole Steps

- (a) Steps shall conform to ASTM C478 for manhole steps, they shall be 19mm either hot dipped galvanized cold rolled steel or aluminum alloy.
- (b) All steps shall be complete with approved polyethylene anchor insulating sleeves and installed in 25mm to 26 mm precast drilled holes in a manhole section.
- (c) Distance between manholes steps shall be maximum 400 mm, with the first manhole step being a maximum 500mm from top of the manhole. Manhole steps shall conform with the most up to date Worksafe BC's standard *G13.2(1)(b) Ladders in manholes*.
- (d) Manhole steps shall be installed 75mm into the manhole section wall.

6. Manhole Platforms

- (a) Manhole platforms are generally not required. Design of manholes shall consider use of appropriate safety equipment.
- (b) A cage, well or ladder safety device shall be provided where the length of climb is greater than 6 metres.
- (c) If platforms are necessary, ladders shall meet the following requirements:
 - The ladder shall consist of multiple sections.
 - Each section shall be horizontally offset from adjacent sections.
 - A landing platform shall be provided within the length of climb.
 - Refer to the standard drawings for additional details.

7. Concrete for Manholes

- (a) The compressive strength of concrete used shall not be less than 20 MPa at 28 days.
- (b) All concrete shall contain an air entrainment agent to provide 4% to 6% air content.

3.10 Service Boxes

Service boxes for sanitary services shall be 305 mm x 508 mm Concrete boxes complete with cast iron lid. The lettering shall read "SEWER".

Service boxes shall not be installed, they shall be supplied to the Regional District of Nanaimo's works yard.

3.11 Service Connections

Service connection piping shall be as detailed elsewhere in this standard.

Each service shall have its own independent connection into the main sewer.

Service connections shall have a minimum grade of 2% unless otherwise directed by the Engineer.

Services shall be constructed in accordance with the standard drawings.

Minimum cover for services shall be 0.75m at property line.

In rock, the trench is to be excavated minimum 1m into the property.

Approved watertight caps suitably supported by sandbags to prevent leakage shall be installed on sewer services at the terminus of each service.

A 50 mm x 100 mm wood marker stake shall be placed at the end of the service connection. The stake shall be painted red with the depth to invert of service to the nearest 0.01m marked. The wood marker stake shall be a minimum 3m from the service box

4. TESTING AND INSPECTION

4.1 Written Reports

The applicant shall submit reports to the Regional District certified by a Professional Engineer of the tests and requirements specified herein.

4.2 Materials Testing

If, in the opinion of the Engineer, testing is required, the Engineer will arrange for a testing firm to carry out tests to determine whether the applicable standards and specifications have been met. Where initial testing indicates inadequacies additional testing may be required by the engineer.

The Contractor as directed by the engineer shall supply specimens or samples for testing.

The types of tests listed below may be required by the engineer unless in the opinion of the Engineer other testing is required.

Joints for sanitary sewer main pipe and fittings and service connection pipe fittings shall be capable of meeting the following exfiltration tests. The Engineer may require that these tests be carried out by the contractor or his supplier prior to the acceptance of pipe on the project.

(a) Pipes in Proper Alignment:

Not fewer than 3, or more than 5, pipes selected from stock by the Engineer shall be assembled according to standard installation instructions issued by the manufacturer. With ends bulkheaded and restrained against internal pressure, the section shall be subjected to 70 kPa hydrostatic pressure. Pressure shall be maintained for a period of 24 hours. There shall be no leakage at the joints.

(b) Pipes in Maximum Deflected Position:

At least 2 of the joints of the assembly shall be deflected to the maximum amount recommended by the manufacturer. 35 kPa internal hydrostatic pressure shall then be applied to the test section and maintained for a period of 24 hours. Joints shall show no leakage.

(c) Pipes in Maximum Lateral Misalignment:

The test section shall be supported on blocks or otherwise so that one of the pipes is suspended freely between adjacent pipes and bears only on the jointing material. The suspended pipe shall then be loaded on the bell or coupling by a load equal to one-third of the ultimate 3-edge bearing strength required by the applicable ASTM specification, except that pipe having a laying length of more than 1.2 m shall be loaded no more than the amount computed for a 1.2 m length. While under this load, stressed joints shall show no leakage under 35 kPa internal hydrostatic pressure.

4.3 Leakage Testing of Gravity Sewers & Manholes

Leakage test shall be performed by the contractor on all sanitary sewers and service connections, manholes and appurtenances.

1. Type of Test:

- (a) Leakage testing on gravity sewers shall be tested with low pressure compressed air.
- (b) Leakage tests on concrete, ductile iron and HDPE gravity sewers shall be ex-filtration water tests.
- (c) Leakage tests on manholes shall be ex-filtration water tests
- (d) Testing shall only be carried out after the pipe has been backfilled, and only on completed sections between manholes.
- (e) All test results to be witnessed by the Engineer or the Engineer's Representative.

2. Testing Equipment:

The Contractor shall furnish all the necessary testing equipment, including suitable removable watertight plugs and test balls and shall perform the tests in a manner satisfactory to the Engineer. Testing equipment must provide readily observable and reasonable accurate measurements of leakage under the specified conditions. The Contractor must comply with all Worksafe BC regulations covering the use of air testing, and ensure that safe working practices are used in the application of the test.

3. Leakage Testing with Water:

Ex-filtration Testing:

On an exfiltration test, the test section shall be sealed at the lower extremity by means of a watertight plug. The test section shall be filled with water such that a minimum hydrostatic head of 600 mm minimum head shall be maintained for a period of not less than one hour, and unless excess exfiltration requires further testing, not greater than 8 hours. Pressures in excess of 3 metres water are not recommended. Damage resulting to pipe as a result of testing shall be repaired by the Contractor at his own expense.

Manholes shall be tested for leakage by filling the chamber to the underside of the roof slab with water. Water level shall be rechecked following a minimum time period of four hours. No leakage shall be permitted in manholes.

In areas where the groundwater table is above the sewer invert level, the test shall be increased by a height equal to the distance from the sewer invert level to the water table elevations.

Ex-filtration test sections shall normally have a manhole at both extremities. If, however, sewer grades are such that a test section cannot be terminated at a manhole without placing excess pressure on the pipe or joints, apparatus shall be provided to enable testing without having manholes at the upper and lower ends of a test section.

Gravity sewers, service connections appurtenant structures thereon shall be constructed such that leakage, as evidenced by exfiltration tests, is less than that calculated using the following formula:

$$\text{Allowable leakage in litres} = \frac{HDL}{5200}$$

Where: H = duration of test in hours,
D = inside diameter of the pipe in millimetres, and
L = length of pipe in the test section in metres

The above leakage limit will constitute the total maximum allowable leakage of any test section of gravity sewer. Where service connections exist along the test section, the allowable leakage from service pipe calculated by the use of the above formula will be added to that of the main sewer to arrive at the total allowable leakage unless the elevation of the service connection pipe is greater than the maximum water elevation. No additional leakage allowance will be made for manholes existing along the test section.

The maximum allowable leakage for an ex-filtration test will be that calculated by the above formula regardless of the test head of water employed. Where a section of sewer is found to have leakage exceeding the allowable limit, replacement or repairs shall be made to reduce the amount of leakage to or below the allowable limit. Repaired sections shall be retested until they meet the allowable limit.

All point sources of leakage discovered during the leakage testing shall be made watertight by the Contractor to the satisfaction of the Engineer.

The Contractor shall dispose of the water used for testing in a manner approved by the Engineer.

4. Leakage Testing With Air:

On an air test, the section to be tested shall be plugged at each end and all service laterals, stubs and fittings properly capped or plugged.

Air shall be supplied to the test section slowly, filling the line to a constant pressure of 24.0 kilopascals (kPa). The air pressure inside the pipe shall not exceed 27.5 kPa except in the case where the groundwater level is above the sewer line being tested. In the event of the groundwater level being above the invert, the air test pressure must be increased by 1.0 kPa for each 100 mm of groundwater above the invert.

The air supply is throttled to maintain the internal pressure above 20.75 kPa for a minimum of 5 minutes to stabilize the temperature in the pipe. After stabilization, the air pressure is adjusted to 24.0 kPa, timing commences and the time required for the line pressure to drop to 17.25 kPa is noted.

If the time required to drop from 20.75 to 17.25 kPa is greater than allowable, the test section shall have passed.

For the air test the minimum time allowable is calculated from the following tables:

Time Requirements for Air Testing

PIPE SIZE (Millimetres)	TIME	
	Min.	Sec.
100	02	32
150	03	50
200	05	06
250	06	22
300	07	39

PIPE SIZE (Millimetres)	TIME	
	Min.	Sec.
375	09	35
450	11	34
525	13	30
600	15	24

Where various pipe sizes are to undergo the air test, the average size shall be used.

5. Testing of Forcemains

Following final trench backfilling, leakage tests shall be performed on all installed piping.

Leakage tests shall be carried out between valved sections of the installation such that every valve in the system is tested for leakage in the shut-off position.

Leakage tests shall be performed in the following manner. The section to be tested shall be filled with water and all air expelled from the piping. It is recommended that the test section be filled with water for at least 24 hours prior to testing. By pumping water into the test section, the pressure within the piping shall be increased to 0.7 MPa, or 1-1/2 times the system operating pressure at the point of test, whichever is the greater. This pressure shall be maintained constantly in the pipe throughout the duration of the test by the addition of make-up water. The duration of the test section to maintain the specified pressure over the period of test shall be considered to be the leakage.

Piping will not be accepted until the leakage is less than the maximum allowable leakage determined from the following formula:

$L = ND \times \text{the square root of } P$ in which:

L = the allowable leakage in litres per hour,

N = the number of joints in the test section,

D = the nominal diameter of the pipe in millimetre,

P = the average test pressure during the leakage test in megapascals.

Should any test disclose leakage greater than that specified above, the defect shall be located and repaired, and the section shall be retested to ensure that the leakage is within the allowable limits.

4.4 Cleaning and Flushing

On completion of sewer pipe installation, the pipes shall be cleaned to the satisfaction of the Engineer and the Regional District of Nanaimo.

Sewer lines shall be cleaned and flushed prior to video inspection.

Material displaced from flushing sewer lines shall be collected with a vacuum truck at a downstream manhole. Under no circumstances shall the material be flushed into the downstream system.

4.5 Video Inspection of Sewer Mains

All gravity sewers except services shall be video inspected to check alignment, grade, and condition of the sewer pipe.

1. Video inspections shall be of the following quality:

- (a) Camera lens shall be free of grease or other deleterious matter to ensure optimal clarity.
- (b) Videos shall be free of steaming and fogging encountered during the inspection.
- (c) The camera shall pan to the service connections and pause for at least five seconds.
- (d) Illumination depth of field shall be no less than 3 joints for standard joint and spigot pipe types to allow for pipe deflection assessments (9m). No dark circle shall be visible in the middle of this depth of field viewing area.

2. The inspections submission shall include:

- (a) A pipe condition report including code descriptions used for describing the condition of the pipe.
- (b) Video shall be submitted on a 4.7GB DVD.

The Engineer shall review all videos and certify that the pipe is installed in accordance with these standards and in accordance with the manufactures recommendations.

If directed by the Engineer, the contractor shall arrange for a re-inspection of the pipe at the contractors cost, for the warranty inspection one month prior to the end of the maintenance period.

Video inspection and pipe condition coding shall be undertaken only by personnel with current certification by a Regional District approved agency.

If video inspection does not meet the standards set out here, the contractor shall re-video and re-submit the video at their own cost.

4.6 Inspection

- 1. The Regional District of Nanaimo shall be given 48 hours notice of all tests.

5. TRANSFERRING THE SEWER SYSTEM TO THE RDN

5.1 Final Inspection by RDN

Prior to requesting a Final Inspection, the registered B.C. Professional Civil Engineer shall submit to the Regional District complete Record Documents, a completed letter Certification of Installed Works, all applicable inspection and test results (video inspection DVD's, leakage testing, etc.), and Certificate of Approval for electrical works (pump stations, wells, lighting, controls, etc.) The Final Inspection shall be arranged by the Professional Engineer on completion of the work. This shall be directed by the Professional Engineer in the presence of approved representatives of the Regional District and the installation Contractor. A complete list of deficiencies identified during the final inspection shall be prepared by the Professional Engineer. Once the deficiencies have been satisfactorily rectified, the Professional Engineer shall so notify the Regional District. The date of the Final Inspection will generally be regarded as the

commencement of the guarantee period, unless significant deficiencies critical to the effective operation of the system are found at the inspection, at the discretion of the Regional District.

5.2 Preparation/Execution of Transfer Agreement by Developer

The Developer shall prepare and execute the Transfer Agreement for the works to the Regional District.

5.3 Preparation/Execution of Maintenance Agreement

The Developer shall guarantee the workmanship and the performance of the work as per the Maintenance Agreement, from the date of acceptance (generally the RDN final inspection date) for a period of two years. This shall be additionally secured by way of cash or an irrevocable letter of credit in the amount of 5% of the cost of construction as certified by a B.C. Professional Civil Engineer, or \$10,000.00 (whichever is greater).

The RDN may reduce the length of the guarantee period and/or the amount of the security. The RDN may also require additional payment, or payout a credit as appropriate, related to an adjustment of the initial engineering fee to final construction cost values, in accordance with RDN Bylaw No. 1259.03 or most recent amendment. Any change to the guarantee period, security amount or the engineering fee is required to be in writing.

5.4 Preparation/Execution of Latecomer Agreement

Where a latecomer agreement may be applicable to a portion of the costs of the works, as agreed by the Regional District and any other applicable jurisdictions, the Developer shall pay all costs of both the Regional District and the Developer associated with the preparation, execution, and registration of the necessary Latecomer Agreement. The Regional District will assume any internal staff costs involved in planning, reviewing, approving, and administering the Latecomer Agreement preparation, and any administrative and financial costs involved during the effective time-period of the agreement. Based on current legislation, a Latecomer Agreement expires 10-years after its initial registration.

5.5 Letter of Acceptance of the Works by RDN

Following completion of all the foregoing requirements, the Regional District will issue the formal Letter of Acceptance of the Works.

The Regional District will also issue a written statement that the new works can be connected to the District's existing system. Such connection shall be undertaken by the applicant under the direct supervision of the District or by the District at a cost to the applicant.

**REGIONAL DISTRICT OF NANAIMO
BYLAW NO. 500**

**LAKES DISTRICT AND SCHOONER COVE
COMMUNITY SEWER SYSTEM STANDARDS**

APPENDIX 1

STANDARD DRAWINGS

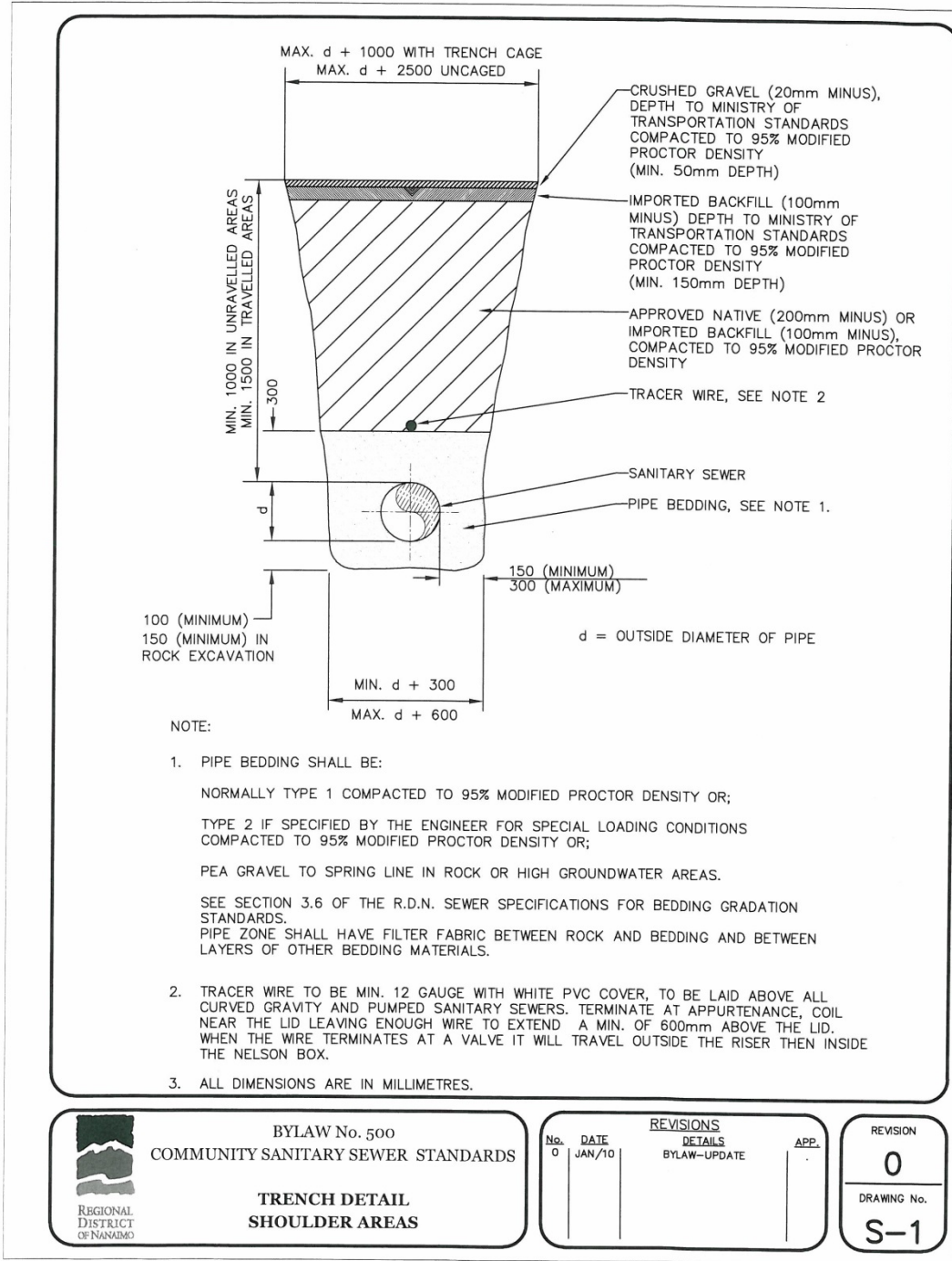

 BYLAW No. 500
COMMUNITY SANITARY SEWER STANDARDS

**TRENCH DETAIL
SHOULDER AREAS**

REVISIONS		
No.	DATE	DETAILS
0	JAN/10	BYLAW-UPDATE
		APP.

REVISION
0
DRAWING No.
S-1

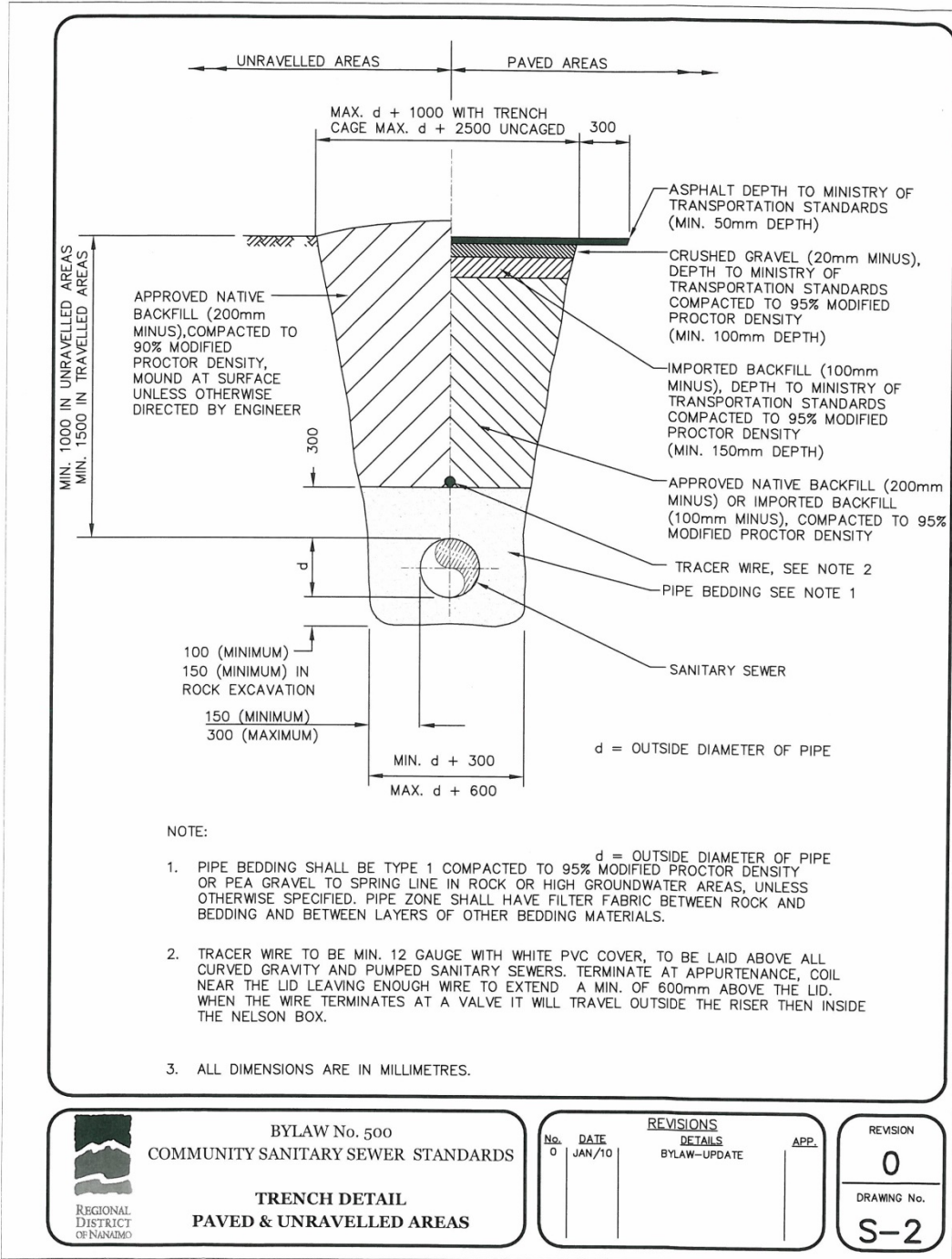

BYLAW No. 500
COMMUNITY SANITARY SEWER STANDARDS

TRENCH DETAIL
PAVED & UNRAVELLED AREAS

REVISIONS		
No.	DATE	DETAILS
0	JAN/10	BYLAW-UPDATE
		APP.

REVISION
0
DRAWING No.
S-2

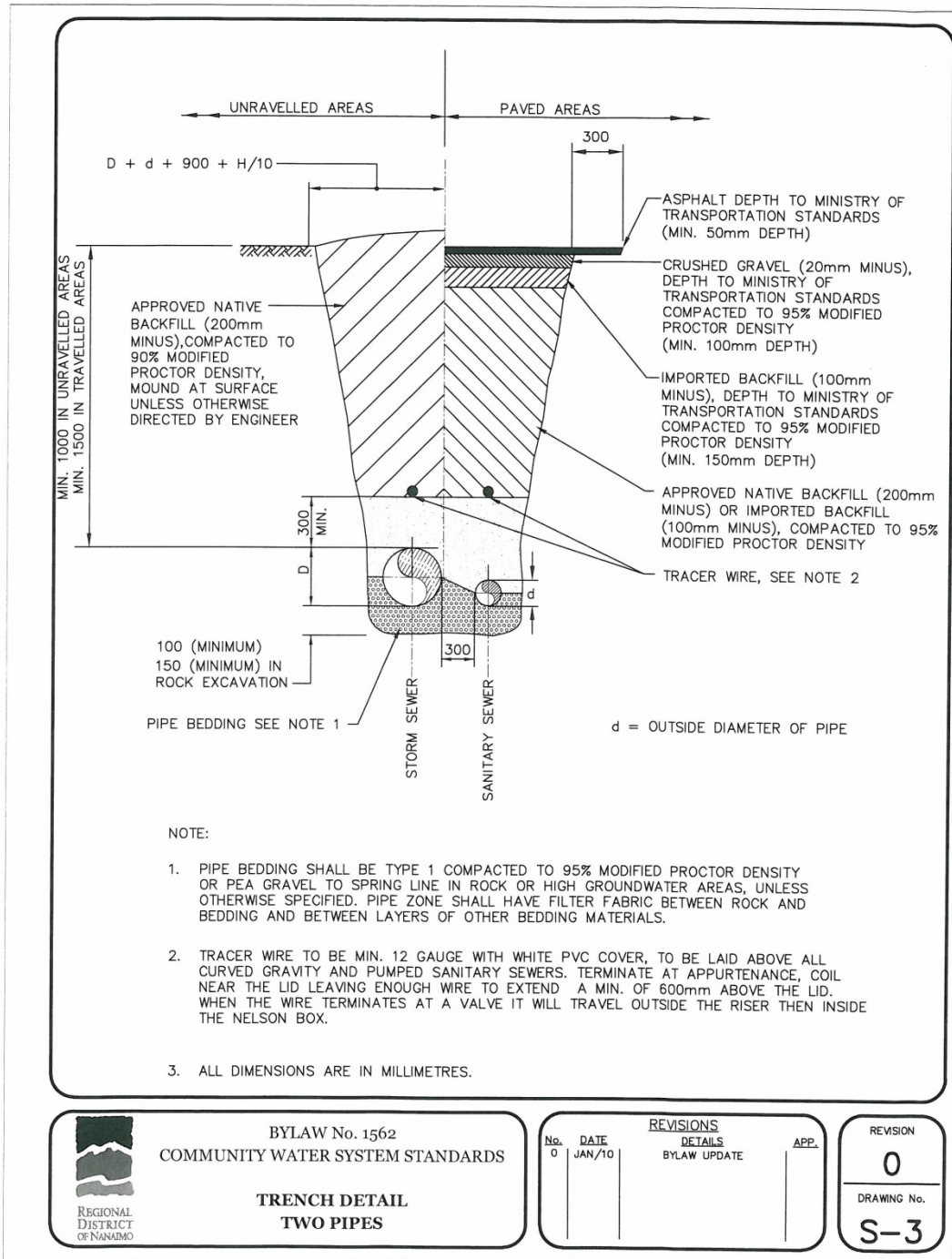

BYLAW No. 1562
COMMUNITY WATER SYSTEM STANDARDS

**TRENCH DETAIL
TWO PIPES**

REVISIONS		
No.	DATE	DETAILS
0	JAN/10	BYLAW UPDATE
		APP.

REVISION
0
DRAWING No.
S-3

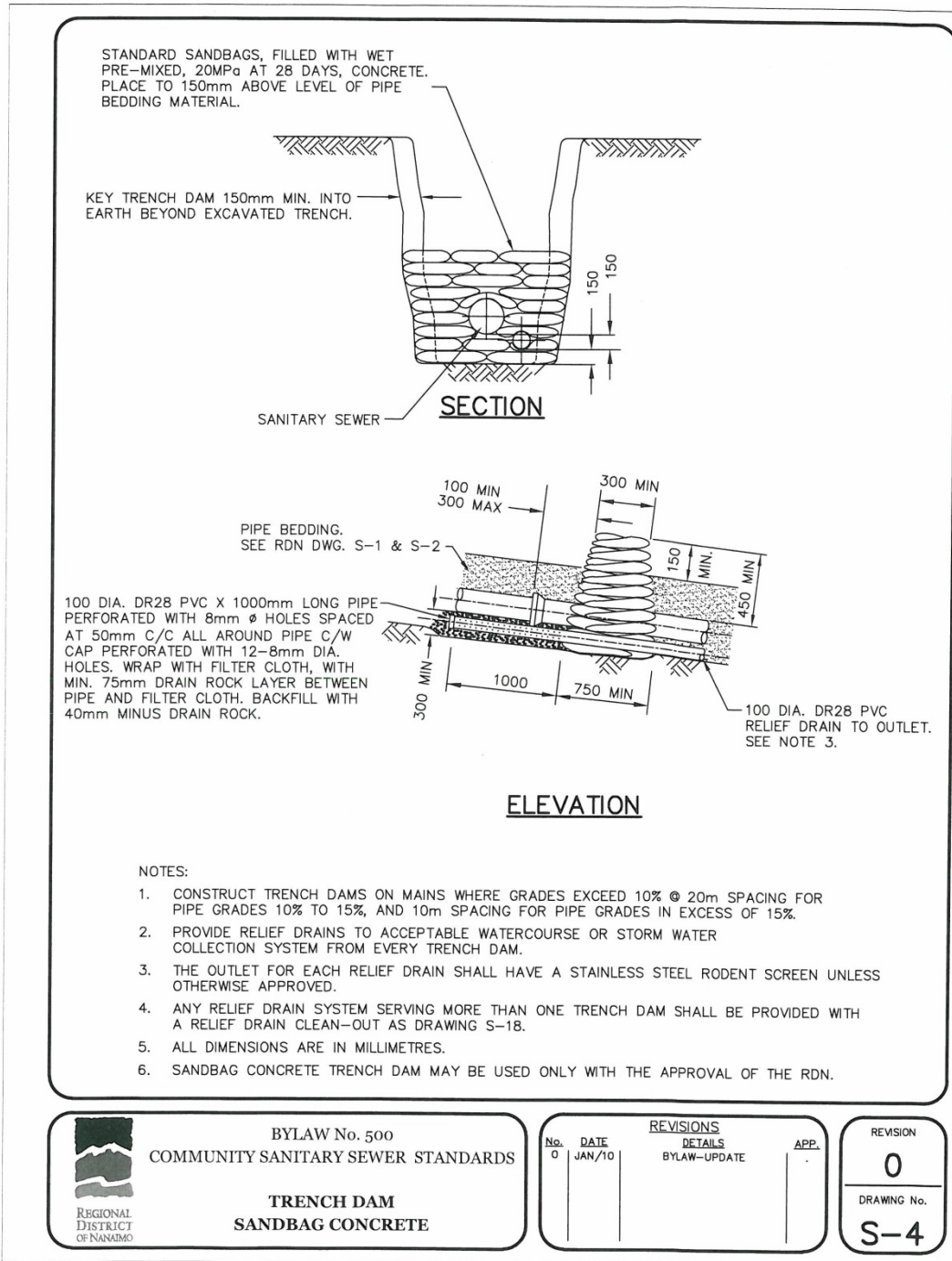

BYLAW No. 500
COMMUNITY SANITARY SEWER STANDARDS

**TRENCH DAM
SANDBAG CONCRETE**

REVISIONS		
No.	DATE	DETAILS
0	JAN/10	BYLAW-UPDATE

REVISION
0
DRAWING No.
S-4

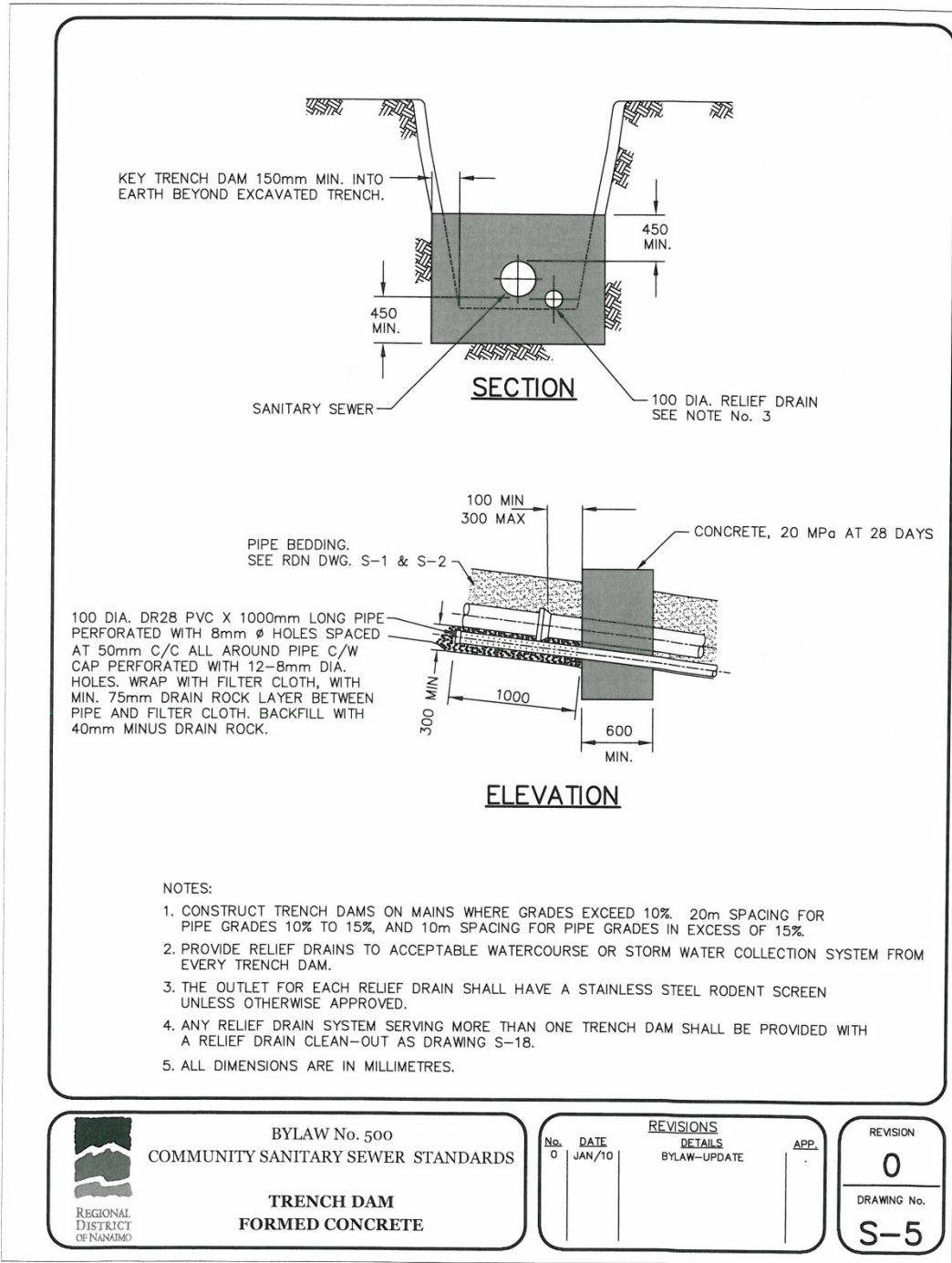



BYLAW No. 500
COMMUNITY SANITARY SEWER STANDARDS

**TRENCH DAM
FORMED CONCRETE**

REVISIONS		
No.	DATE	DETAILS
0	JAN/10	BYLAW-UPDATE
		APP.

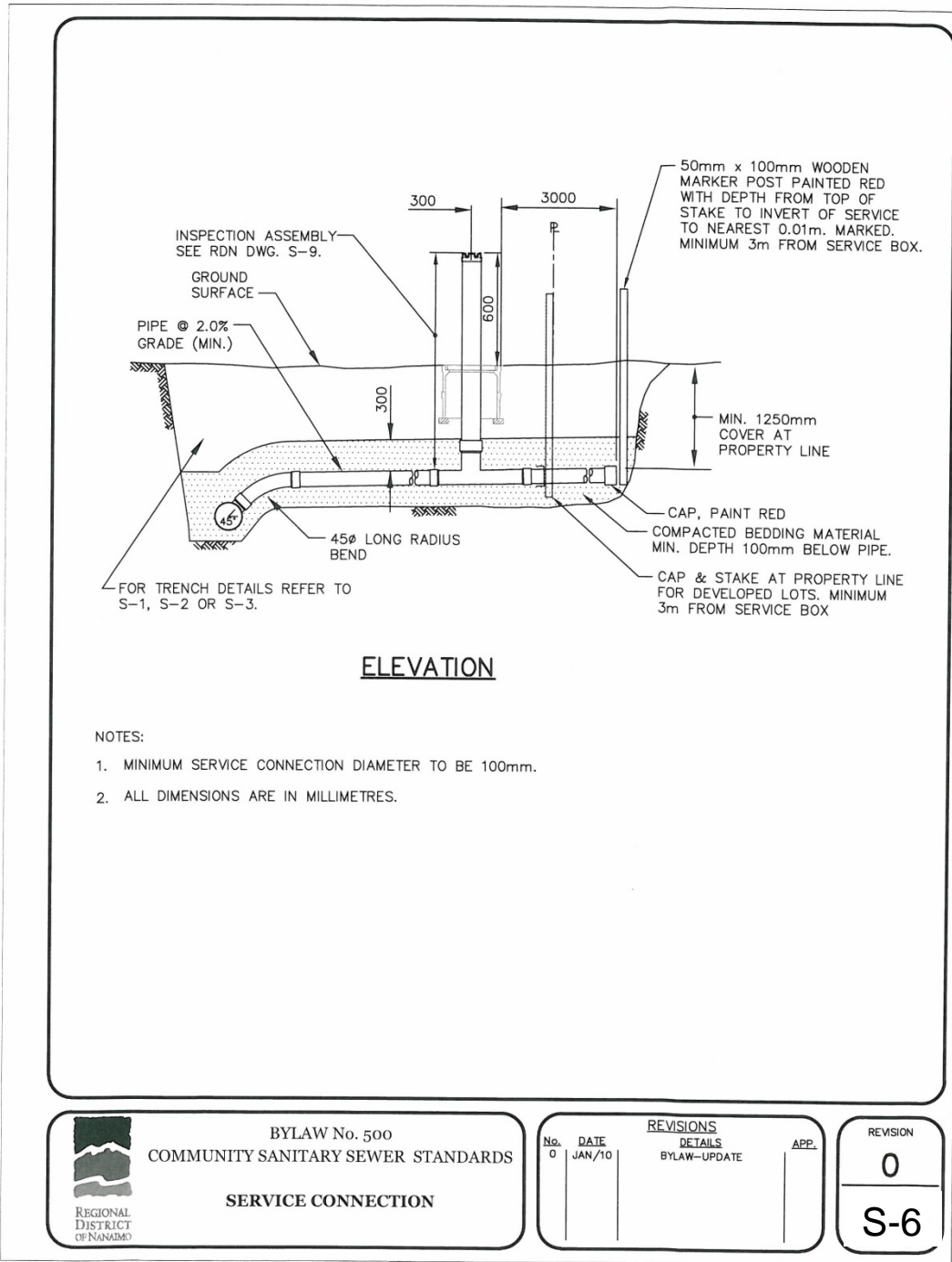
REVISION
0
DRAWING No.
S-5



 BYLAW No. 500
 COMMUNITY SANITARY SEWER STANDARDS
SERVICE CONNECTION

REVISIONS		
No.	DATE	DETAILS
0	JAN/10	BYLAW-UPDATE
		APP.

REVISION
0
S-6

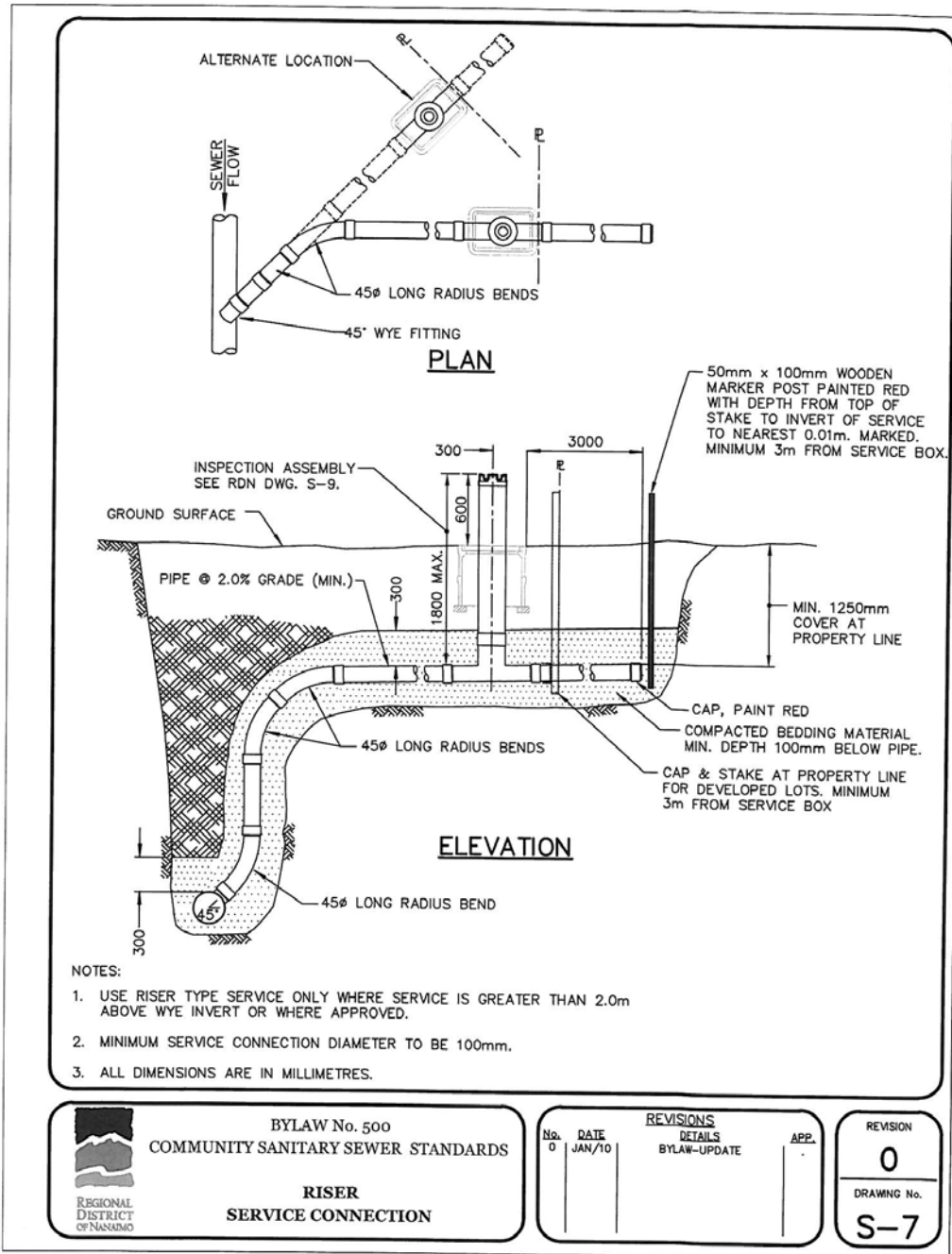

BYLAW No. 500
COMMUNITY SANITARY SEWER STANDARDS

**RISER
SERVICE CONNECTION**

No.	DATE	REVISIONS		APP.
		DETAILS	BYLAW-UPDATE	
0	JAN/10			

REVISION
0
DRAWING No.
S-7

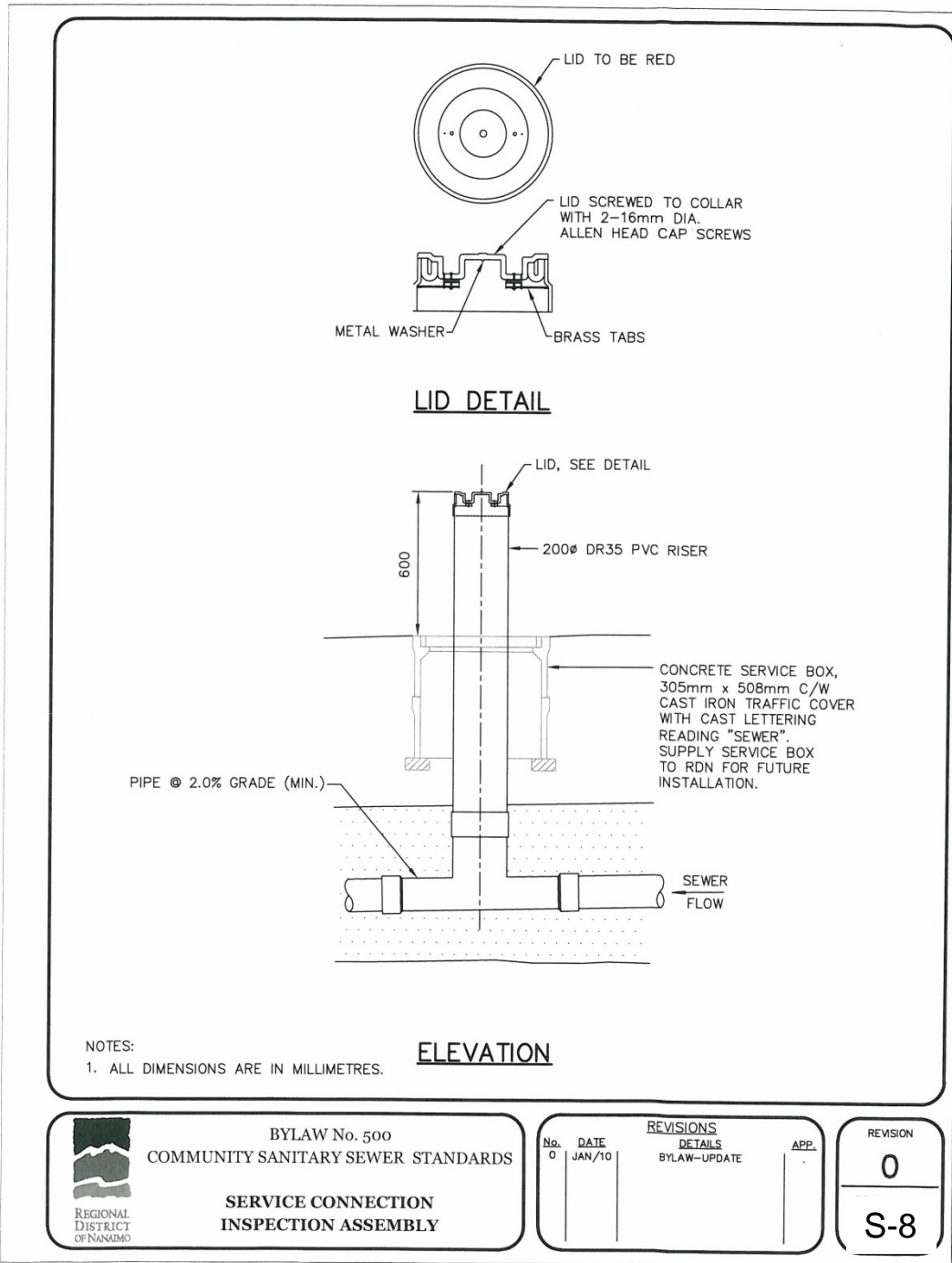

BYLAW No. 500
COMMUNITY SANITARY SEWER STANDARDS

**SERVICE CONNECTION
INSPECTION ASSEMBLY**

REVISIONS		
No.	DATE	DETAILS
0	JAN/10	BYLAW-UPDATE
		APP.

REVISION
0
S-8

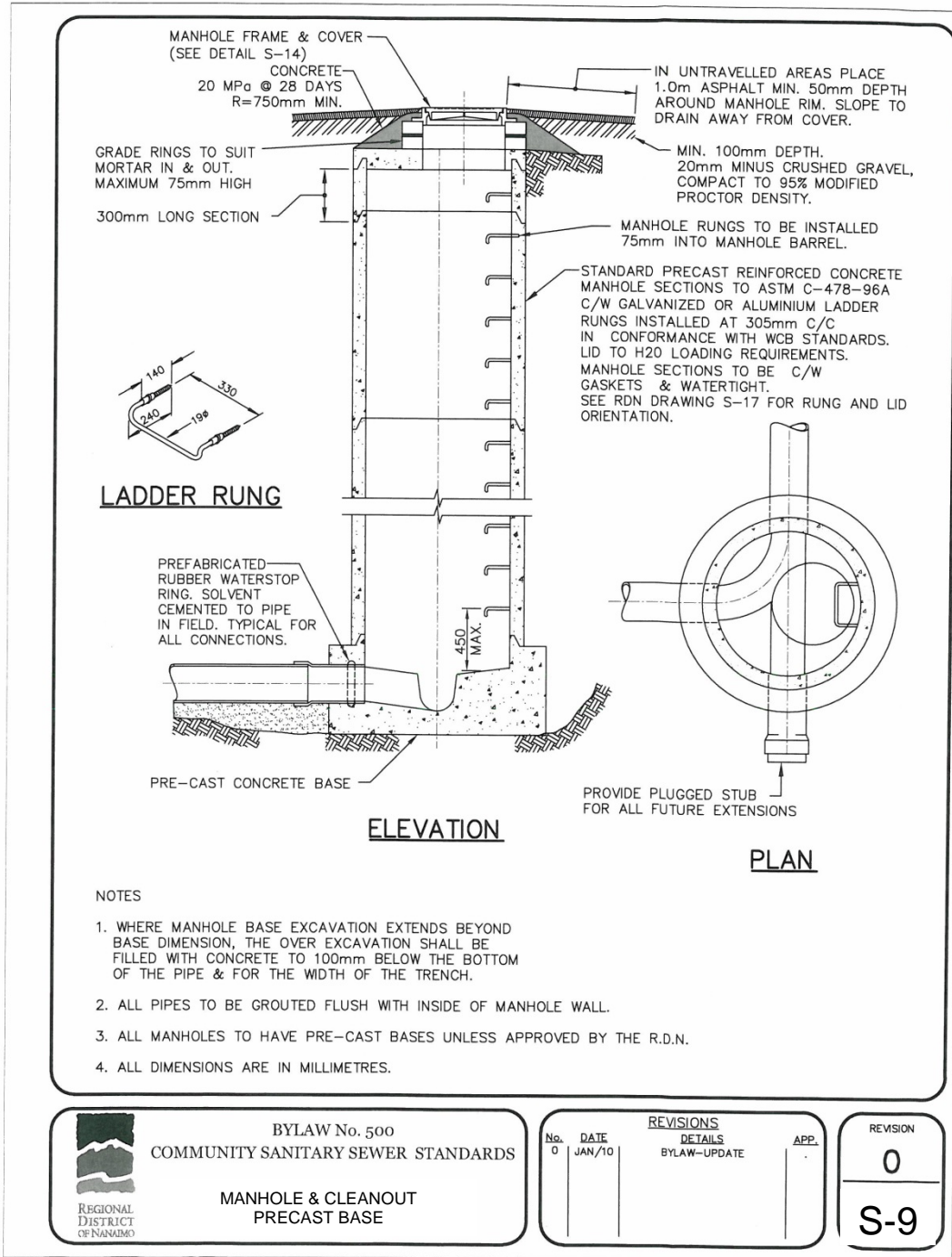

BYLAW No. 500
COMMUNITY SANITARY SEWER STANDARDS

MANHOLE & CLEANOUT
PRECAST BASE

REVISIONS		
No.	DATE	DETAILS
0	JAN/10	BYLAW-UPDATE
		APP.

REVISION
0
S-9

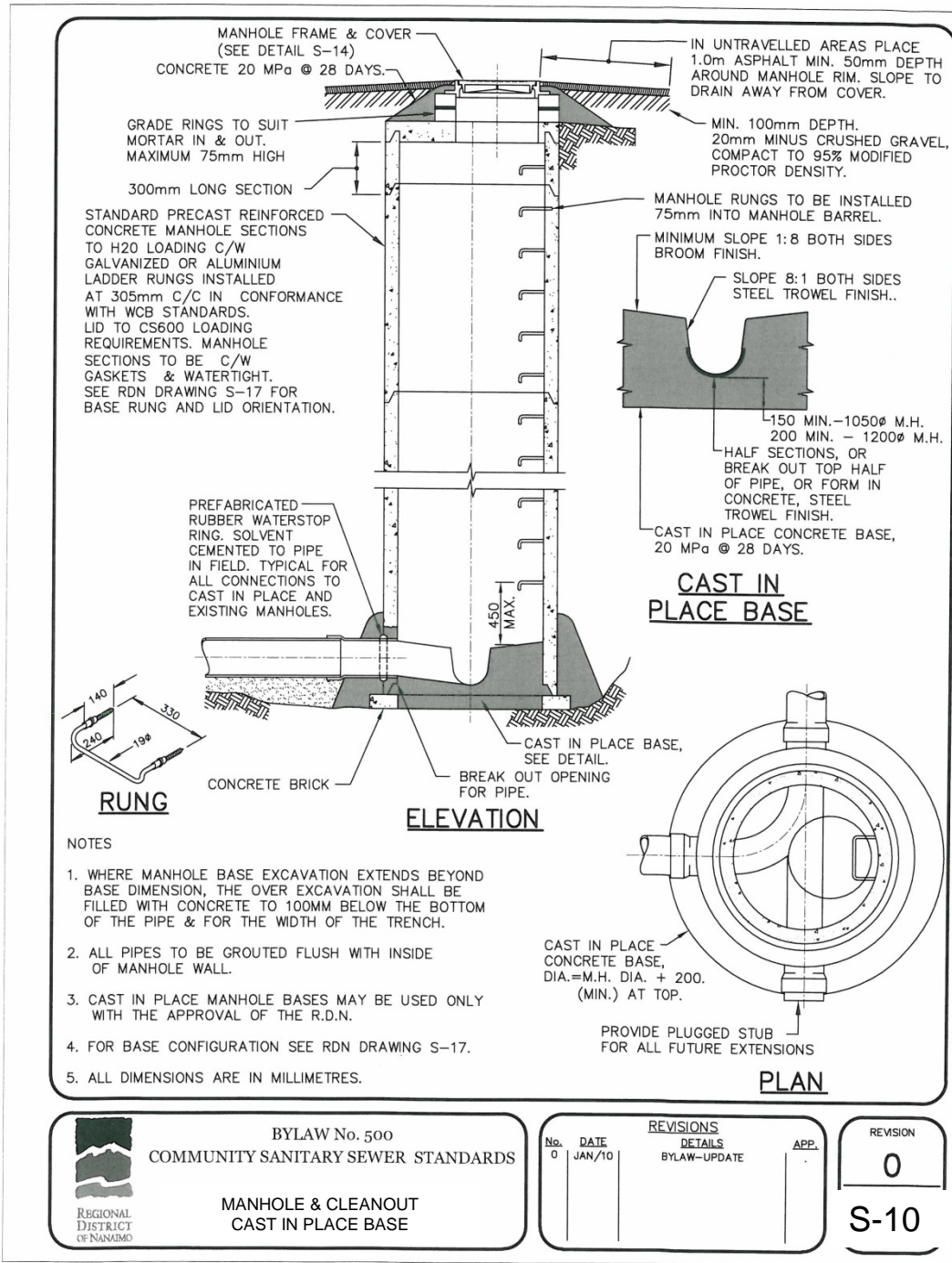

BYLAW No. 500
COMMUNITY SANITARY SEWER STANDARDS

MANHOLE & CLEANOUT
CAST IN PLACE BASE

REVISIONS		
No.	DATE	DETAILS
0	JAN/10	BYLAW-UPDATE
		APP.

REVISION
0
S-10

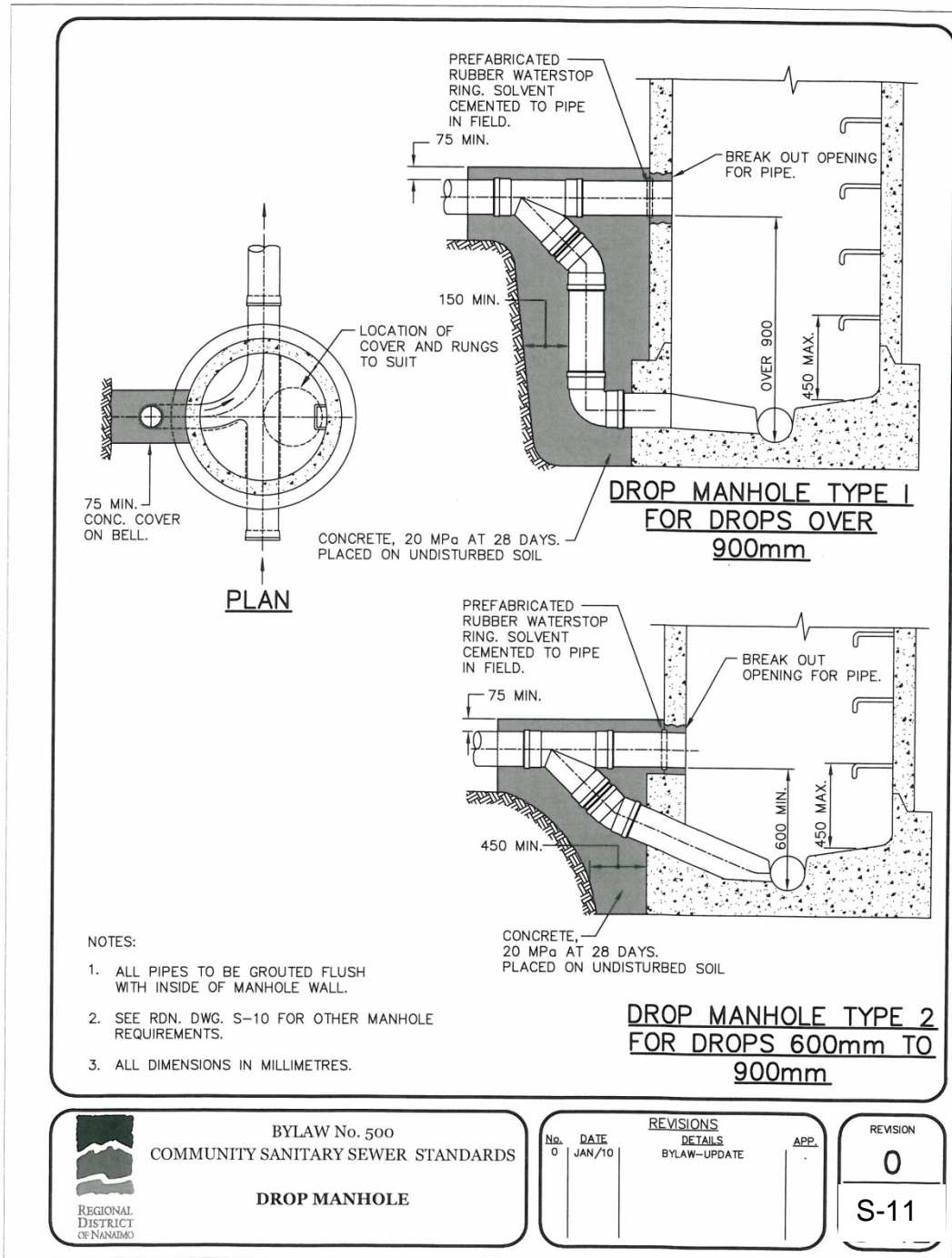

BYLAW No. 500
COMMUNITY SANITARY SEWER STANDARDS

DROP MANHOLE

REVISIONS			APP.
No.	DATE	DETAILS	
0	JAN/10	BYLAW-UPDATE	

REVISION
0
S-11

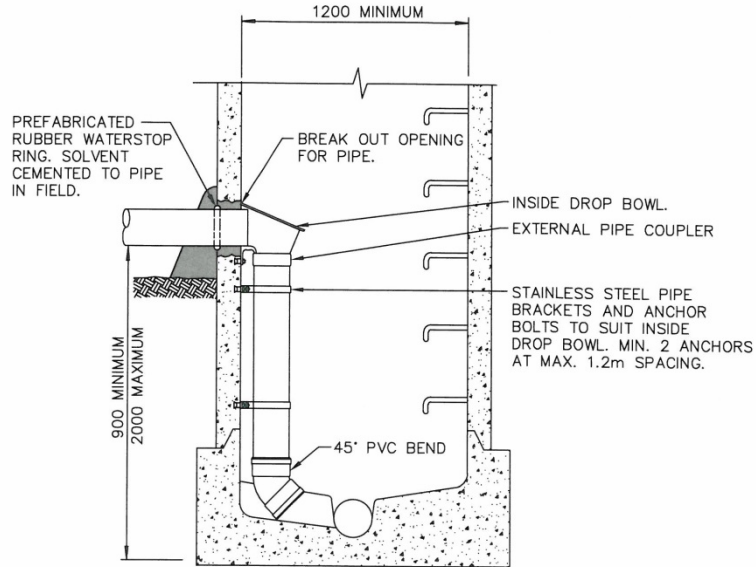

DROP MANHOLE TYPE 3
FOR DROPS OVER 900mm

NOTES:

1. DROP MANHOLE TYPE 3 TO BE USED ONLY WITH THE WRITTEN PERMISSION OF THE RDN. APPROVAL WILL ONLY BE GRANTED FOR SITUATIONS WHERE MODIFICATIONS TO EXISTING MANHOLES ARE PROPOSED.
2. DROP PIPE TO BE DR28 PVC, DIA. TO SUIT INSIDE DROP BOWL.
3. THIS DRAWING SHOWS INSIDE DROP ONLY. SEE RDN DWG. S-10 FOR ALL OTHER DETAILS PERTAINING TO MANHOLE REQUIREMENTS.
4. ALL MOUNTING & BRACKET HARDWARE, (STRAPS & BOLTS) SHALL BE STAINLESS STEEL
5. ALL DIMENSIONS ARE IN MILLIMETRES.



BYLAW No. 500
COMMUNITY SANITARY SEWER STANDARDS

INSIDE DROP MANHOLE DETAILS

REVISIONS		
No.	DATE	DETAILS
0	JAN/10	BYLAW-UPDATE
		APP.

REVISION
0
S-12

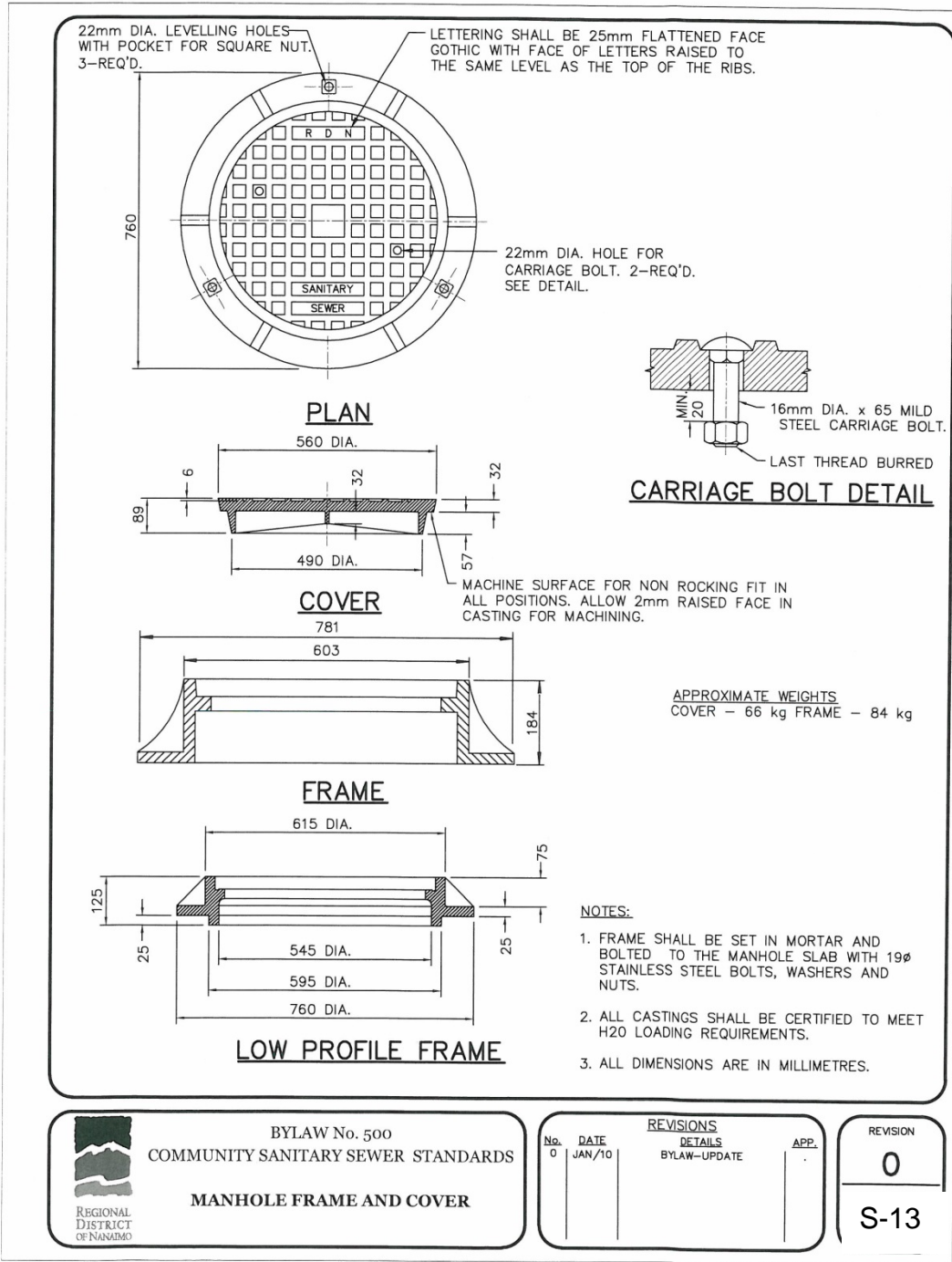

BYLAW No. 500
 COMMUNITY SANITARY SEWER STANDARDS

MANHOLE FRAME AND COVER

REVISIONS		
No.	DATE	DETAILS
0	JAN/10	BYLAW-UPDATE
		APP.

REVISION
0
S-13

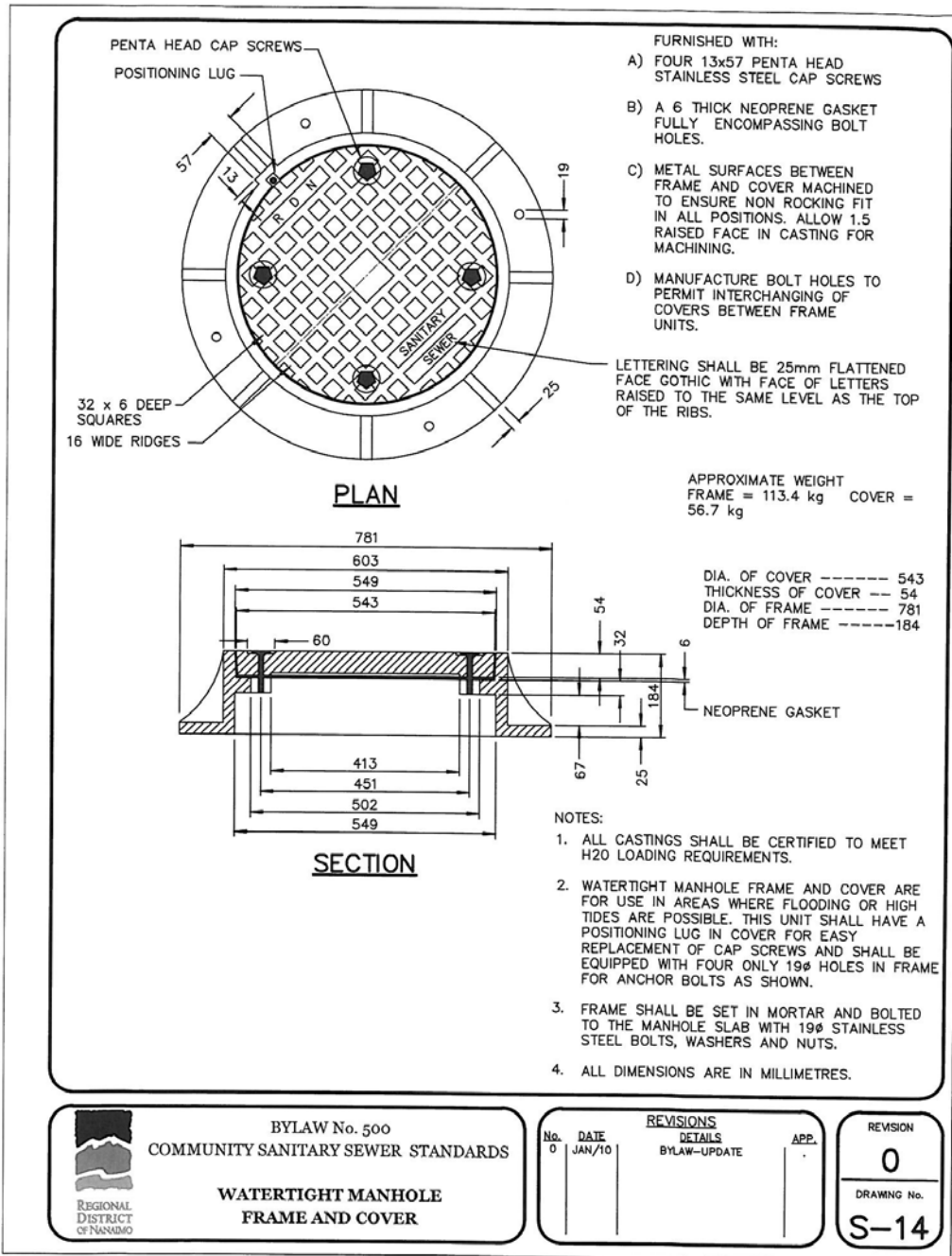

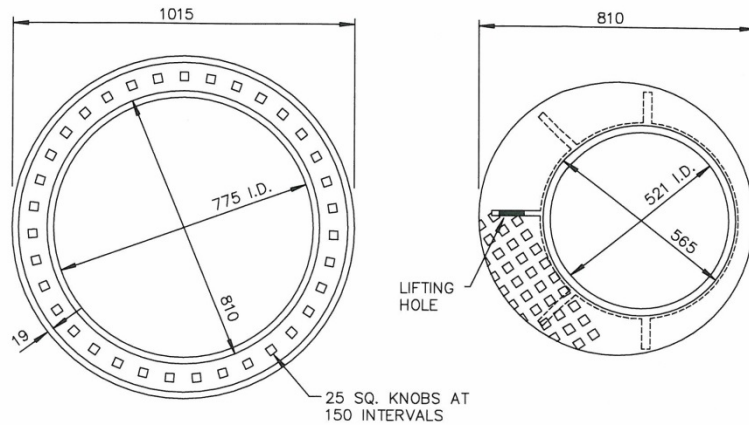

PLAN OF FRAME

PLAN OF OUTER RING

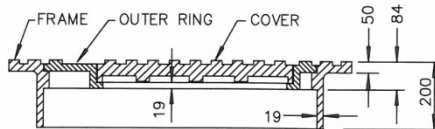

SECTION
FRAME, RING AND COVER

- NOTES:
1. THIS MANHOLE FRAME AND COVER IS TO BE USED FOR ACCESS TO UNDERGROUND UTILITY CHAMBERS INCLUDING PUMP STATIONS OR WHERE A LARGER ACCESS DIAMETER IS REQUIRED.
 2. ALL CASTINGS SHALL BE CERTIFIED TO MEET H2O LOADING REQUIREMENTS.
 3. FOR COVER LETTERING AND BOLTING REQUIREMENTS REFER TO RDN DWG. S-14.
 4. ALL DIMENSIONS ARE IN MILLIMETRES



BYLAW No. 500
COMMUNITY SANITARY SEWER STANDARDS

UTILITY CHAMBER
MANHOLE FRAME, RING AND COVER

REVISIONS			
No.	DATE	DETAILS	APP.
0	JAN/10	BYLAW-UPDATE	

REVISION
0
S-15

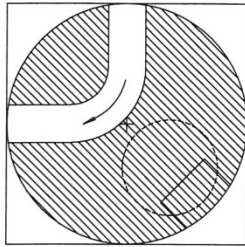

1. RIGHT ANGLE BEND

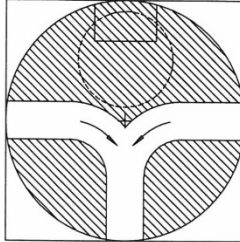

2. TEE CONNECTION

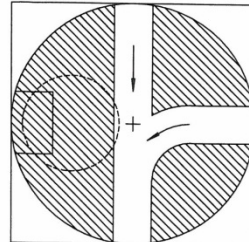

3. THREE WAY JUNCTION

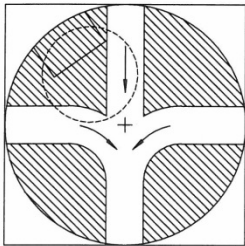

4. FOUR WAY JUNCTION

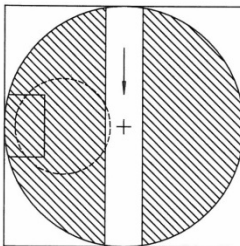

5. STRAIGHT THROUGH

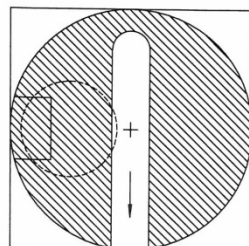

6. DEAD END

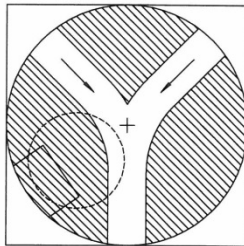

7. WYE CONNECTION

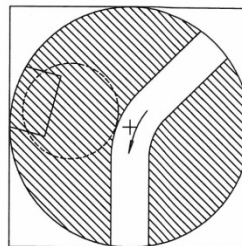

8. 45° BEND

NOTES

1. ALL CHANNELS SHALL BE FINISHED WITH A STEEL TROWEL. BENCHING (SHADED AREAS) SHALL BE BROOM FINISHED.
2. MANHOLE COVER OPENINGS AND RUNG LOCATIONS SHALL BE AS SHOWN UNLESS OTHERWISE NOTED ON THE CONSTRUCTION DRAWINGS.





BYLAW No. 500
 COMMUNITY SANITARY SEWER STANDARDS

CAST IN PLACE
 MANHOLE BENCHING

No.	DATE	REVISIONS	
		DETAILS	APP.
0	JAN/10	BYLAW-UPDATE	

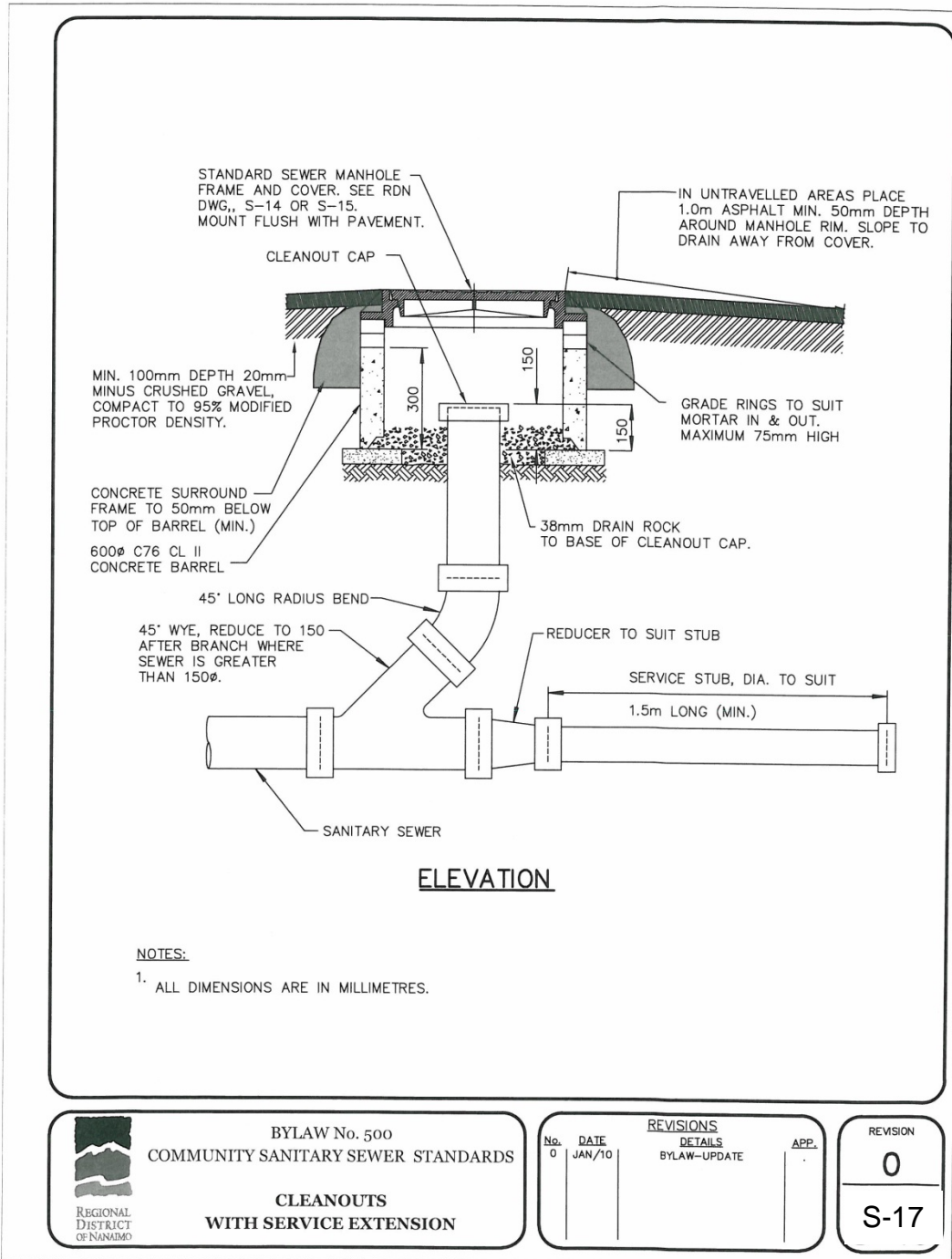
REVISION
0
S-16





BYLAW No. 500
COMMUNITY SANITARY SEWER STANDARDS
CLEANOUTS
WITH SERVICE EXTENSION

REVISIONS			
No.	DATE	DETAILS	APP.
0	JAN/10	BYLAW-UPDATE	

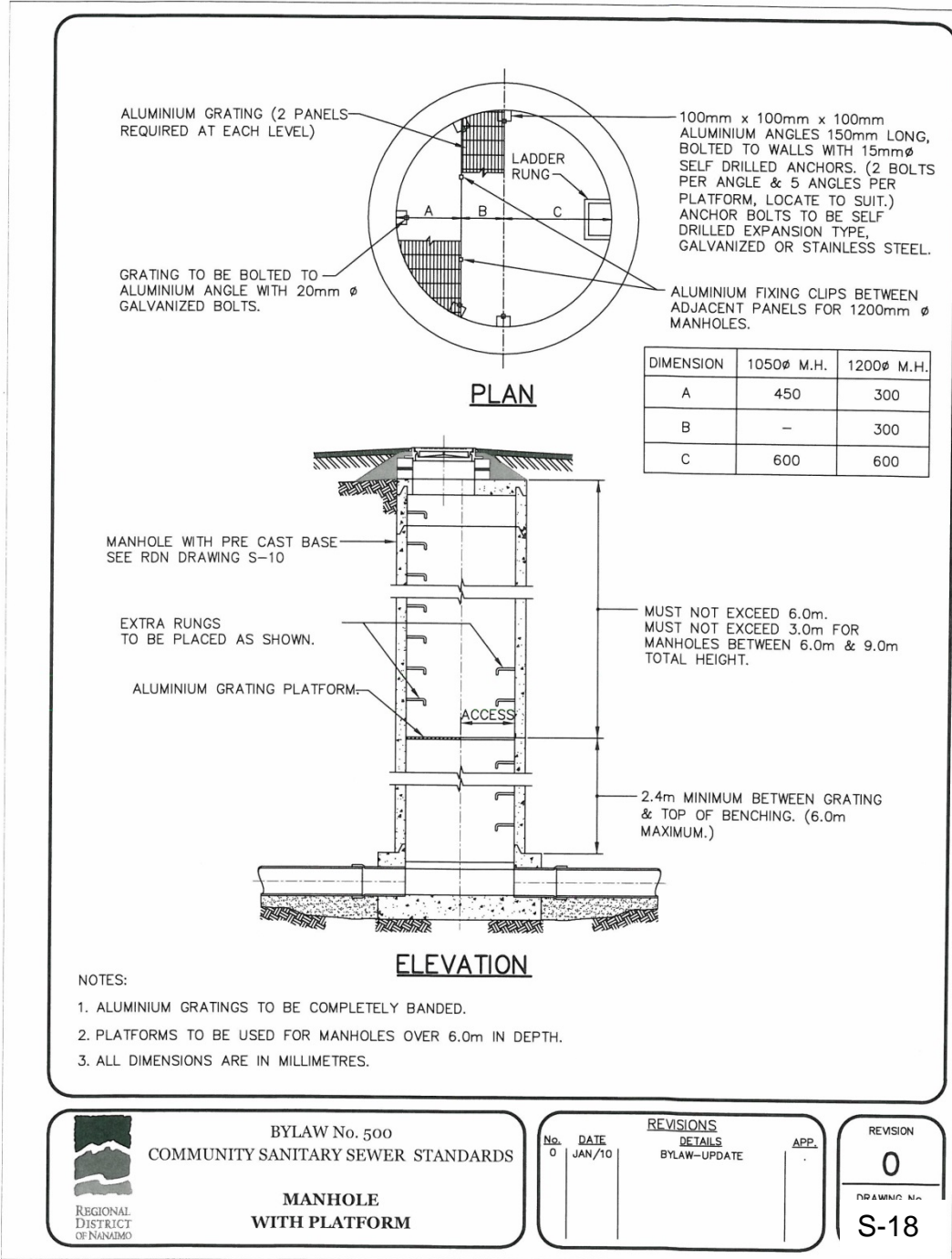
REVISION
0
S-17

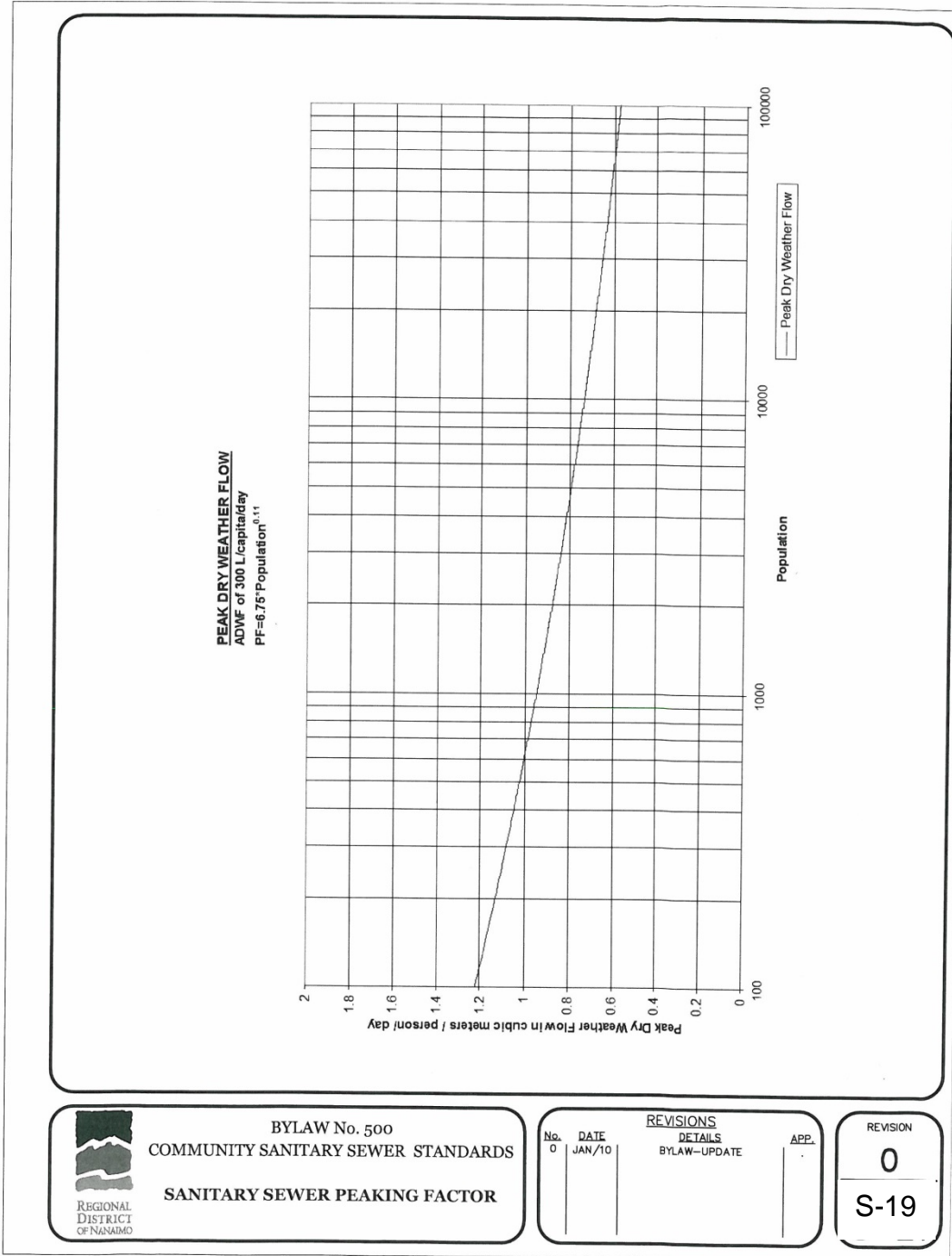



**REGIONAL DISTRICT OF NANAIMO
BYLAW NO. 500**

**LAKES DISTRICT AND SCHOONER COVE
COMMUNITY SEWER SYSTEM STANDARDS**

APPENDIX 2

LETTER OF ASSURANCE



LETTER OF ASSURANCE

NOTE:

To be submitted at time of Feasibility Review

To: Manager of Engineering Services
 Regional District of Nanaimo
 6300 Hammond Bay Road
 Nanaimo BC V9T 6N2

RE: _____

 (Project)

Date: _____, 20__.

This will confirm that (Developer _____) has retained (Consultant _____) to provide, design, contract administration, inspection and as-constructed drawings for this project all in accordance with the current bylaws and standards of the Regional District and in accordance with good engineering practice.

(Developer)

This confirms we have accepted this assignment on the above terms.

(Consultant)

**REGIONAL DISTRICT OF NANAIMO
BYLAW NO. 500**

**LAKES DISTRICT AND SCHOONER COVE
COMMUNITY SEWER SYSTEM STANDARDS**

**APPENDIX 3
CERTIFICATE OF DESIGN**



CERTIFICATE OF DESIGN

I, _____, a Professional Engineer registered in the Province of British Columbia, hereby certify that the works as herein set out on the attached drawings entitled _____

_____ have been designed in accordance with the Regional District of Nanaimo Bylaw 500 and/or in accordance with good engineering practice where such design is not covered by the Regional District Bylaw 500.

I have been retained to provide design, supervision, full-time inspection, as-built drawings, and final certification for this project by:

(Name of Client)

I am satisfied that in the contractual mandate which exists between myself and my client, the terms of reference will permit me to render a level of supervision of the construction work which will allow me to put my name and seal to the "Certification of Installed Works" required by the Regional District of Nanaimo, a sample of which is attached to this document and initialed by me.

In the event that my client releases me from this project, or in the event that I find the terms of reference do not permit me to render a level of supervision of the construction work which will allow me to put my name and seal to the form of certification required by the Regional District of Nanaimo, I will notify the Regional District within twenty-four (24) hours verbally and follow it up with written confirmation and clarification.

Signed this _____ day of _____, 20____.

_____, P.Eng.

(signature)

(name printed)

I understand that the "Certification of Installed Works" is to be completed in this format and submitted with the "as-constructed" drawings.

(Engineer)

**REGIONAL DISTRICT OF NANAIMO
BYLAW NO. 500**

**LAKES DISTRICT AND SCHOONER COVE
COMMUNITY SEWER SYSTEM STANDARDS**

APPENDIX 4

CERTIFICATION OF INSTALLED WORKS



CERTIFICATION OF INSTALLED WORKS

NOTE: To be completed in this format and submitted with the 'As-Built' drawings

Location of the Construction Site and Works: (Legal Description / Location)

all within the Regional District of Nanaimo, British Columbia.

I, _____, a Registered Professional Engineer (Reg. No. _____) in the Province of British Columbia, hereby certify:

4. THAT the following construction tests were carried out to confirm that construction met the specifications required:

- a) _____
- b) _____
- c) _____
- d) _____
- e) _____
- f) _____

5. THAT I was able to monitor the construction and provide a level of supervision of the construction work sufficient to be able to confirm that the specifications in force and effect by the Regional District of Nanaimo and in the applicable design drawings for the said Works were generally met during the Construction Period; and

6. THAT the accompanying plans labeled:

- (i) _____
- (ii) _____
- (iii) _____

accurately record the materials, grades, inverts, offsets and dimensions of the constructed work.

DATED this _____ day of _____, 20 _____.

Engineer (signature & seal)

Engineering Firm

**REGIONAL DISTRICT OF NANAIMO
BYLAW NO. 500**

**LAKES DISTRICT AND SCHOONER COVE
COMMUNITY SEWER SYSTEM STANDARDS**

APPENDIX 5

STANDBY IRREVOCABLE LETTER OF CREDIT

[BANK LETTERHEAD]

Letter of Credit No. _____ Amount: _____
Applicant _____ Initial Expiry Date: _____
_____ Beneficiary: _____
For the account of _____
(Name of Customer)
up to an aggregate amount of _____ available on demand.

Pursuant to the request of our customer, we hereby establish and give you a Standby Irrevocable Letter of Credit in your favour in the above amount which may be drawn on by you at any time and from time to time, upon written demand for payment made upon us by you, which demand we shall honour without enquiring whether you have the right as between yourself and the said customer to make such demand, and without recognizing any claim of our said customer, or objection by it to payment by us. This Letter of Credit relates to those Regional District of Nanaimo services and financial obligations set out in an Agreement between the customer and the Regional District of Nanaimo and briefly described as:

The amount of this Letter of Credit may be reduced from time to time as advised by notice in writing to us by the Regional District of Nanaimo. Partial or full drawings may be made. This Letter of Credit shall expire at 3:00 p.m. on _____. This Letter of Credit will continue in force for a period of 1 year, but shall be subject to the condition hereinafter set forth. It is a condition of the Letter of credit that it shall be deemed to be automatically extended without amendment from year to year from the present or any future expiration date hereof, unless at least 30 days prior to the present or any future expiration date, we notify you in writing by registered mail, that we elect not to consider this Letter of Credit to be renewable for any additional period. This Letter of Credit is subject to the Uniform Custom and Practice for Documentary Credits (1993 Revision) International Chamber of Commerce Publication No. 500.

DATED at _____, British Columbia, this ____ day of _____, 20__.

(Name of Bank)

(Address of Bank)

PER: _____
(Authorized Signature)

REGIONAL DISTRICT OF NANAIMO

BYLAW NO. 500

PART 4

SUBDIVISION REGULATIONS

PART 4 - SUBDIVISION REGULATIONS

4.1 Subdivision Districts

- 1) For the purpose of this Bylaw, the area described in the section of this Bylaw entitled **Application** is hereby divided into subdivision districts as provided in Schedule '4B'.
- 2) The extent of each subdivision district is shown on Schedule '4A'.
- 3) Where a subdivision district boundary does not follow a legally defined line, and where the distances are not specifically indicated, the location of the boundary shall be determined by scaling from Schedule '4A'.
- 4) Where a subdivision district boundary is designated as following a highway or watercourse, the centreline of the highway or the natural boundary of the watercourse or centreline of a creek shall be the subdivision district boundary.
- 5) Any land not included in any subdivision district by Schedule '4A' shall be deemed to be in Subdivision District A.

4.2 Prohibition

Land shall not be subdivided contrary to this Bylaw.

Subdivision Standards

4.3 Parcel Size

- 1) Minimum parcel size requirements for each subdivision district shall be in accordance with Schedule '4B'.
- 2) A panhandle shall not be considered part of a parcel for the purpose of calculating parcel size in any subdivision district described in this Bylaw.
- 3) The minimum parcel size shall be increased as necessary:
 - a) to suit the topography; and
 - b) to ensure that the gradient of an access driveway or a panhandle to service the proposed lots shall not exceed 20%.
- 4) Parcels within land to be subdivided may be reduced to 80% of the size otherwise permitted in the applicable subdivision district, provided that:¹
 - a) a maximum of 50% of the proposed parcels within the land to be subdivided may be reduced in size, unless a higher percentage has been approved by way of a development variance permit; and
 - b) the average parcel size of all parcels within the subdivision conforms with the parcel size permitted in the applicable subdivision district; and
 - c) a restrictive covenant in favour of the Regional District is registered against all parcels in the subdivision prohibiting further subdivision of the land unless the largest parcel created within the subdivision is less than twice the minimum parcel size applicable to that parcel at the time of subdivision.

¹ Bylaw No. 500.13, adopted October 13, 1987

4.4 Parcels Exempt from Minimum Parcel Size Requirements

- 1) Where the requirements of the authority having jurisdiction are met with respect to the provisions of water and method of sewage disposal, minimum parcel size and parcel servicing regulations shall not apply to a subdivision:
 - a) combining 2 or more parcels into a single parcel;
 - b) where the effect of subdivision would not be to increase the number of parcels, but to adjust the boundary between existing parcels, provided that the boundary change does not result in the reduction of either parcel by 20% or more of its original size;
 - c) adding an accretion to a parcel.

- 2) Parcels which consist of 2 or more parts physically separated by:
 - a) a highway which was dedicated prior to the adoption of this Bylaw;
 - b) the Nanaimo River, the Englishman River, the Little Qualicum River, or the Qualicum River;
 - c) a railway under jurisdiction of the applicable **Railway Act** and amendments thereto; may be subdivided along the dividing highway, the natural boundaries of the noted rivers, or the railway even when the newly created parcels fail to meet the minimum parcel size requirements of this Bylaw, provided the requirements of the authorities having jurisdiction are met with respect to the provision of water, method of sewage disposal and access.

- 3) Parcels proposed for subdivision pursuant to Section 946 of the **Local Government Act** shall be permitted provided that:¹
 - a) all requirements of provincial legislation are satisfied; and
 - b) the new parcel being created by subdivision is a minimum of 1.0 ha²; except where the parent parcel was connected to a community water service prior to the adoption, on June 10, 2003 of the “Regional District of Nanaimo Regional Growth Strategy Bylaw No. 1309, 2002”, then the minimum parcel size shall be no less than 2500m²; and
 - c) the size of the remainder of the parcel is the minimum size required under Schedule '4A' and '4B' of this Bylaw; and
 - d) all other requirements of this Bylaw are met.

Design and Servicing Standards

4.5 Parcel Shape and Dimensions

- 1) The depth of each parcel of land in a subdivision shall not exceed 40% of the length of the perimeter of the parcel, excluding any panhandle, unless the proposed subdivision will create parcels substantially closer to compliance with this provision than the existing parcel.

- 2) Unless the pattern of existing subdivision precludes it, side lot lines shall, wherever practicable, be created perpendicular or radial to the adjoining highway.

¹ Bylaw No. 500.69, adopted September 8, 1992

² Bylaw No. 500.320, adopted November 22, 2005

- 3) No panhandle shall be created:
 - a) narrower than 10.0 m where further subdivision of the parcel is possible; or
 - b) narrower than 6.0 m where further subdivision is not possible.

- 4) No parcel shall be created which is divided into 2 or more non-contiguous portions of land not included within the parcel or remainder, except a remainder which is divided into non-contiguous portions by the width of a highway allowance, provided that:
 - a) such a highway was in existence prior to the subdivision; and
 - b) it is impracticable to establish the non-contiguous portions as separate parcels.

4.6 Highway Requirements

- 1) No proposed highway to be dedicated by a plan of subdivision shall be shown on a plan, dedicated, laid out or constructed unless the design, dimensions, locations, alignment and gradient meet the requirements for highways, as established from time to time, by the Ministry of Transportation.

- 2) Additional dedicated rights of way of up to 6.0 m may be required for bus stop areas near key intersections.

- 3) A subdivision pursuant to the **Strata Property Act** and amendments thereto the following minimum access route standards shall apply along with any further requirements by the Ministry of Transportation:¹

PAVED WIDTH	PARKING
6.0 m	On street parking not permitted - parking provided in accordance with Schedule '3B'
8.5 m	On street parking permitted on one side

4.7 Sewage Disposal

- 1) Where a parcel is created and is not served by a community sewer system the authority having jurisdiction must be satisfied as to the sewage disposal capability of the parcel.

- 2) Any community sewer system, or part thereof, provided within the subdivision, to service the subdivision or to connect the sewage collection system within the subdivision to a Regional District trunk sewage main shall, if constructed after the enactment of this Bylaw, be constructed and installed at the expense of the owner of the land being subdivided and shall be carried out in accordance with the standards and specifications set out in Schedule '4D'.

- 3) Notwithstanding Section 4.7 (1), for lands within the Lakes District and Schooner Cove Community Water and Sewer Standards Area, all parcels shall be serviced by a community sewer system.²

- 4) Notwithstanding Section 4.7 (2), for lands within the Lakes District and Schooner Cove Community Water and Sewer Standards Area, any community sewer system, or part thereof, provided within the subdivision, to service the subdivision or to connect the sewage collection system within the subdivision to a Regional District trunk sewage main shall, be constructed and installed at the expense of the owner of the land being

¹ Bylaw No. 500.61, adopted March 27, 1990

² Bylaw No. 500.388, adopted July 22, 2014

subdivided and shall be carried out in accordance with the standards and specifications set out in Schedule '4D1'.¹

4.8 Water Supply

- 1) Where a parcel to be created is not to be served by a community water system and is less than 5.0 ha in area, the applicant shall provide reasonable proof to the satisfaction of the Approving Officer that a minimum year-round potable water supply of 3.5 m³ per day can be provided for each parcel being created.
- 2) Any community water system, or part thereof, provided within the subdivision, to service the subdivision or to connect the water distribution system within the subdivision to a Regional District trunk water main shall, if constructed after the enactment of this Bylaw, be constructed and installed at the expense of the owner of the land being subdivided and shall be carried out in accordance with the standards and specifications set out in Schedule '4C'.
- 3) Notwithstanding Section 4.8 (1), for lands within the Lakes District and Schooner Cove Community Water and Sewer Standards Area, all parcels shall be serviced by a community water system.²
- 4) Notwithstanding Section 4.8 (2), for lands within the Lakes District and Schooner Cove Community Water and Sewer Standards Area any community water system, or part thereof, provided within the subdivision, to service the subdivision or to connect the water distribution system within the subdivision to a Regional District trunk water main shall, be constructed and installed at the expense of the owner of the land being subdivided and shall be carried out in accordance with the standards and specifications set out in Schedule '4C1'.³
- 5) The standards and specifications set out in Schedule '4C' do not apply to community water system owned, operated and maintained by a municipality or an improvement district, or a community water system which is operated by a person required to hold a certificate of public convenience and necessity under the **Water Utility Act**.⁴

4.9 Exception

Subdivision regulations to not apply to:

- a) parcels to be used solely for unattended public utility use;
- b) park.

¹ Bylaw No. 500.388, adopted July 22, 2014

² Bylaw No. 500.388, adopted July 22, 2014

³ Bylaw No. 500.388, adopted July 22, 2014

⁴ Bylaw No. 500.238, adopted February 10, 1998

REGIONAL DISTRICT OF NANAIMO

BYLAW NO. 500

PART 5

DEVELOPMENT PERMIT AREAS

PART 5 – DEVELOPMENT PERMIT AREAS

TABLE OF CONTENTS

5.1 Development Permit Area Organization 3

5.1.1 Freshwater and Fish Habitat Development Permit Area 4

5.1.2 Sensitive Ecosystems Development Permit Area 11

5.1.3 Eagle and Heron Nesting Trees Development Permit Area 16

5.1.4 Aquifers Development Permit Area 19

5.1.5 Marine Coast Development Permit Area 23

5.1.6 Hazard Lands Development Permit Area 29

5.1.7 Farmland Protection Development Permit Area 33

5.1.8 Yellow Point Aquifer Development Permit Area 36

5.1.9 South Wellington Industrial – Commercial Development Permit Area 40

5.1.10 Cedar Main Street Development Permit Area 44

5.1.11 Cassidy Development Permit Area 57

5.1.12 Cedar Development Permit Area 61

5.1.13 Extension Village Centre – Commercial Development Permit Area 65

5.1.14 East Wellington – Pleasant Valley Industrial Development Permit Area 67

5.1.15 Nanoose Bay Form and Character Development Permit Area 68

5.1.16 Qualicum Bay and Dunsmuir Village Centres Development Permit Area 70

5.1.17 Bowser Village Centre Development Permit Area 74

5.1.18 Multi Residential, Intensive Residential, Industrial and Commercial Form and Character
Development Permit Area 87

5.1.19 Rural Commercial Development Permit Area 92

5.1.20 Highway Corridor Protection Development Permit Area 95

5.1.21 Inland Island Highway Corridor Development Permit Area 96

5.1 Development Permit Area Organization

For the area covered by this bylaw, the relevant official community plan designates development permit areas and describes the special conditions or objectives that justify the designations. The applicability, exemption and guidelines for the development permit areas are contained within this bylaw as within Part 5.

5.1.1 Freshwater and Fish Habitat Development Permit Area

Information Note: the designation of this development permit area and description of the special conditions or objectives that justify the designation are located in the applicable official community plans.

APPLICABILITY

Terms used in this Development Permit Area that are defined in the provincial *Riparian Areas Regulation* (RAR), of the *Riparian Areas Protection Act*, are intended to be interpreted in accordance with the definition given in the Regulation, as it may be amended from time to time. This Regulation and Act may be obtained from the Provincial Ministry of Forests, Lands, Natural Resource Operations and Rural Development or from the BC Laws website.

A development permit is required for the following activities wherever they occur within this Development Permit Area, unless specifically exempted:

1. removal, alteration, disruption, or destruction of vegetation;
2. disturbance of soils; including grubbing, scraping and the removal of top soils;
3. construction or erection of buildings and structures;
4. creation of non-structural impervious or semi-impervious surfaces;
5. flood protection works;
6. construction of roads, trails, docks, wharves, and bridges; and
7. subdivision of land.

EXEMPTIONS

The following activities are exempt from any requirement for a development permit.

Exemptions Applicable to all Watercourses

1. Development in an area where no stream or watercourse exists, or where the proposed development is clearly outside the development permit area, as determined by the Regional District, a BC Land Surveyor, or a Registered Professional Biologist. This exemption does not apply if the stream or watercourse ecosystem was previously filled or realigned without a development permit.
2. Renovations, repairs, maintenance, the construction of a second storey addition, excluding cantilevered construction to existing buildings within the same footprint (a building permit may still be required).
3. All park or parkland ancillary uses not containing commercial, residential, or industrial activities.
4. Emergency procedures to prevent, control, or reduce erosion, or other immediate threats to life and property including:
 - a) emergency flood or protection works;
 - b) clearing of an obstruction from bridge, culvert, or drainage flow, repairs to bridges and safety fences;

5.1.1 Freshwater and Fish Habitat Development Permit Area

- c) any emergency works to be undertaken in accordance with the Provincial *Water Sustainability Act* and *Wildlife Act*, and the federal *Fisheries Act*.

Notwithstanding the above, emergency actions for flood protection and clearing of obstructions by anyone other than the Regional District or Ministry must be reported to the Regional District and applicable Ministry immediately to secure exemption under this provision. Note that once the emergency has passed, a development permit may be required for remediation or permanent protection works.

5. Removal of trees deemed hazardous by a certified Arborist or Registered Professional Forester that pose an imminent threat to buildings or life safety. Removal of hazardous trees that also contain an eagle or heron nest are exempt only if a permit under the *Wildlife Act* has been obtained.
6. The small-scale, manual removal of non-native invasive plants or noxious weeds or planting of non-invasive, native vegetation on a small scale conducted in accordance with best practices such as the Invasive Plant Council of BC's 'Grow Me Instead' publication.
7. The activity is part of a farm operation as defined by the *Farm Practices Protection (Right to Farm) Act*, is a permitted farm use as defined in Section 2(2) of the *Agricultural Land Reserve Use, Subdivision, and Procedures Regulations*, and the lands are assessed as 'farm' under the *BC Assessment Act*. The farm operation of land clearing is only exempt from the requirement of a development permit if conducted in accordance with a current Environmental Farm Plan (less than five years old); otherwise, land clearing as part of a farm operation is not exempt. Note that other provincial legislation such as the *Waste Management Act* and the *Water Sustainability Act* may apply to farm operation activities.
8. Digging of observation holes for percolation testing under supervision of a Registered Onsite Wastewater Practitioner or Professional Engineer, and digging of test pits for geotechnical investigation under supervision of a Professional Engineer.
9. Works conducted and/or approved by the Department of Fisheries and Oceans and/or Ministry of Environment with respect to trail construction, stream enhancement, fish and wildlife habitat restoration and in-stream works as defined by Section 11 of the *Water Sustainability Act*.
10. All forest management activities on lands subject to the *Forest Act* or *Private Managed Forest Land Act* and classified as 'Forest Lands' on the property assessment.
11. Works conducted by the Regional District or its agents where appropriate measures have been undertaken to satisfy the applicable development permit area guidelines as determined by the Regional District.
12. Subdivision where the minimum lot size is met exclusive of the development permit area, and no works are proposed within the development permit area.

Exemptions Applicable to Streams under the RAR only

13. Subdivision where the minimum lot size is met exclusive of the Streamside Protection and Enhancement Area (SPEA), and no works are proposed within the Riparian Assessment Area.
14. Within Electoral Area A, development activities more than 30 metres from the Nanaimo River or Haslam Creek, measured from the top of bank or present natural boundary, whichever is greater, where:

5.1.1 Freshwater and Fish Habitat Development Permit Area

- a. a RAR assessment report has been completed by a Qualified Environmental Professional in accordance with the RAR Assessment Methods and submitted to the province; and
 - b. notification of the assessment report has been received by the provincial ministry responsible and the Regional District.
15. For streams subject to the RAR, in the case where a simple assessment is submitted which assigns a SPEA, a development proposed outside of the SPEA where:
- a) the assessment report has been completed by a Qualified Environmental Professional (QEP) in accordance with the RAR Assessment Methods; and
 - b) notification of the assessment report has been received by the provincial ministry responsible and the Regional District, and there are no measures outside of the SPEA required to protect the SPEA.

Exemptions Applicable to this development permit area where the RAR does not apply

16. Subdivision involving only lot line adjustment. For lot line adjustment to be exempt there must be sufficient developable area outside the development permit area as confirmed by the Regional District, BC Land Surveyor, or Registered Professional Biologist, and there are no works proposed within the development permit area.
17. A property owner may construct a single trail within this development permit area in accordance with the principles and standards of 'Access Near Aquatic Areas' of the Stewardship Series published by the provincial and federal governments, and subject to the following conditions:
- a) the trail provides the most direct route or feasible passage through the development permit area while minimizing the extent of vegetation removal or disturbance and minimizing excavation and removal of native soils;
 - b) the ground is stable, ie. erodible stream banks or other erosion prone areas shall be avoided;
 - c) no motorized vehicles are permitted on the trail;
 - d) the trail is not to exceed a maximum width of 1.5 metres;
 - e) no trees, which are greater than 5.0 metres in height and 10.0 centimetres in diameter, are to be removed; instead limbing and pruning of trees shall be done, where necessary, to facilitate the construction of the single trail;
 - f) the trail's surface shall only be composed of pervious materials.
18. Minor additions to existing buildings or structures to a cumulative maximum of 25 percent of the original ground floor area, if the addition is located on the side or part of the building or structure most distant from the waterbody or stream.
19. The construction of a small accessory building or structure if all the following apply:
- a) the building or structure is located within an existing landscaped area;
 - b) no native trees with a diameter at breast height of 20 centimetres or greater are removed;
 - c) there is no permanent foundation;

5.1.1 Freshwater and Fish Habitat Development Permit Area

- d) the building or structure is located a minimum of 10 metres from the high water mark or, where the bank has a slope greater than 3:1, 10 metres from the top of the bank; and
- e) the total area of the accessory building or structure is less than 10 square metres.

GUIDELINES

Development permits shall be issued in accordance with the following:

Guidelines applicable to all watercourses

1. An assessment must be prepared by a Registered Professional Biologist (a QEP for streams applicable to the RAR) for the purpose of identifying sensitive biophysical features on or near the development permit area and providing recommendations and conditions for development to avoid or mitigate impacts to these features. The assessment should list each guideline with an explanation of how the development is consistent with the guideline, or an explanation as to how the guideline is not applicable. The site plan should indicate the areas for yard and driveway and areas to remain free from development. See Guideline 13 for additional requirements of this report for streams applicable to the RAR.
2. If development or alteration of land is proposed within the development permit area, it shall be located so as to minimize the impact on the stream or waterbody. The assessment report shall include an explanation as to how locating development entirely outside of the development permit area has been considered, and the reason that it is not being proposed. Variances to the zoning bylaw regulations to minimize development in the development permit area should be considered.
3. Sensitive biophysical features to be assessed in this development permit area include but are not limited to:
 - a) forest cover and ecological communities;
 - b) surface drainage patterns;
 - c) site topography and channel morphology;
 - d) aquatic and riparian habitat values, condition and function;
 - e) rare and uncommon species and plant communities; and
 - f) an overall assessment of the ecological importance of the watercourse.
4. Mitigation measures that should be considered in the biological assessment include but are not limited to:
 - a) minimization of vegetation removal;
 - b) maintenance of linkages with adjacent sensitive ecosystems to minimize habitat fragmentation and maintain wildlife corridors;
 - c) sediment and erosion control;
 - d) protection of sensitive areas through fencing or other permanent demarcation; and
 - e) timing of construction to minimize potential impacts.

5.1.1 Freshwater and Fish Habitat Development Permit Area

5. Where the applicant's biologist or other qualified professional recommends revegetation and/or enhancement works, the Regional District may require the applicant to submit a landscaping plan and a security deposit equal to the total estimated costs of all materials and labour as determined by a Landscape Architect or other qualified professional to the satisfaction of the Regional District.
6. For the SPEA or where the applicant's biologist or other qualified professional recommends other specific areas that must remain free from development:
 - a) the Regional District may require a Section 219 covenant to be prepared at the applicant's expense, to the satisfaction of the Regional District, to ensure that the identified areas remain free from development; and
 - b) prior to construction commencing, the installation of temporary fencing or flagged stakes marking the protection area is required to avoid encroachment within the areas to be protected through to the completion of the development.
7. The applicant's biologist or QEP may be required to provide confirmation to the Regional District that the property has been developed in accordance with the QEPs recommendations.

Guidelines Related to Rainwater Management and Protection of Development from Hazardous Conditions

8. On any development where there is potential for silt, petroleum or any other contaminants to enter a watercourse either directly or indirectly through infiltration, provision of oil, grease and sediment removal facilities and the ongoing maintenance of these features will be required.
9. Directing drainage of rainwater from development sites into the SPEA and other watercourses and water bodies shall be avoided. Instead, rainwater is to be managed onsite with an emphasis on infiltration approaches to management. If impacts cannot be avoided through onsite infiltration, a sediment and erosion control plan may be required, and grading plan may be required where fill is placed near the freshwater feature.
10. In low-lying areas subject to flooding, development should not increase the flood risk on the subject property or on adjacent or nearby properties. Where the placement of fill is proposed within a floodplain as defined by the RDN Floodplain Management Bylaw, it shall be designed by a Professional Engineer to ensure that the placement of the proposed fill will not restrict the passage of flood waters, redirect flood flows, decrease natural flood storage, result in higher flood flows or result in higher flood potential elsewhere in the floodplain.
11. Where there is a slope greater than 30 percent over a minimum horizontal distance of 10 metres, an assessment report prepared by a Professional Engineer with experience in geotechnical engineering may be required to assist in determining what conditions or requirements shall be included in the development permit so that proposed development is protected from the hazard and no increase in hazard is posed to existing development. The geotechnical report will form part of the development permit terms and conditions, and may include registration of a Section 219 covenant, prepared at the applicant's expense and to the satisfaction of the Regional District.

Additional Guidelines Applicable to Streams Subject to the RAR only

12. No development shall take place within any SPEA except where:
 - a) a QEP has determined that no serious harm is likely to occur or that it can be mitigated by following prescribed measures; or
 - b) the owner has obtained an authorization under subsection 35(2) [serious harm to fish] of the *Fisheries Act* or Section 11 [changes in and about a stream] of the *Water Sustainability Act*.
13. The Regional District shall require the applicant to retain a QEP, at the expense of the applicant, for the purpose of preparing an assessment report, pursuant to Section 4(2) of the RAR and the RAR Assessment Methodology Guidebook, and the assessment report must be electronically submitted to the provincial ministry responsible, via the Riparian Area Regulations Notification System, and a copy must be provided to the Regional District.
14. In addition to implementing the measures in the assessment report, to ensure the integrity of the SPEA the Regional District and landowner may consider the following:
 - a) gift to a nature preservation organization all or part of the SPEA; or
 - b) register a restrictive covenant or conservation covenant on title securing the measures prescribed in the assessment report.
15. For the purpose of subdivision design, proposed lot configuration shall consider the protection of the SPEA and minimize new lot lines in the SPEA. The proposed lot configuration should demonstrate that enough developable land is available on each lot to establish a development envelope that includes a reasonable yard area outside of the SPEA to accommodate wastewater disposal field, driveway, accessory buildings and yard.
16. Permanent fencing and/or other means of clearly delineating the SPEA boundary such as signage must be designed to follow the standard established by the Regional District and Ministry of Environment shown below. Signage should be installed to the satisfaction of the Regional District prior to land alteration and in the case of subdivision prior to the Regional District notifying the Approving Officer that the conditions of the development permit have been met. Fencing must be maintained in good order.

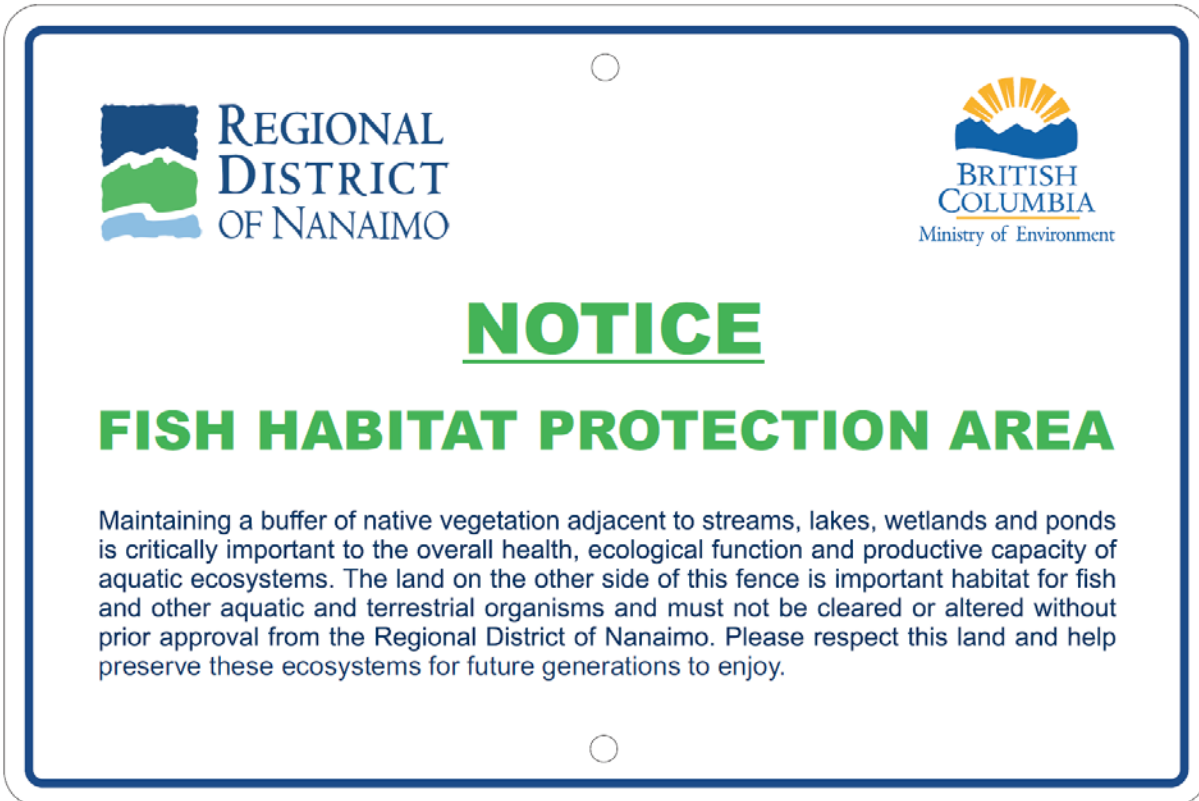

Aluminum or Dibond 12"x18" Radius corners
Inline border .14"
RDN logo: 2"x5.17"
Ministry of Environment logo: 2.5"x2.92"
Notice: Arial black type .90"
Fish Habitat Protection Area: Arial black type .60"
All other text: Arial bold type .27"

5.1.2 Sensitive Ecosystems Development Permit Area

Information Note: the designation of this development permit area and description of the special conditions or objectives that justify the designation are located in the applicable official community plans.

APPLICABILITY

A development permit is required for the following activities wherever they occur within this development permit area, unless specifically exempted:

1. removal, alteration, disruption or destruction of vegetation, including trees, plants and shrubs;
2. disturbance of soils, including grubbing, scraping and the removal of top soils;
3. construction or erection of buildings and structures;
4. creation of non-structural impervious or semi-pervious surfaces; and
5. subdivision of land as defined in the *Land Title Act* or *Strata Property Act*.

EXEMPTIONS

The following activities are exempt from any requirement for a development permit:

1. Development in an area where the sensitive ecosystem does not exist due to mapping inaccuracy, upon written confirmation from a Registered Professional Biologist. For clarity, if the sensitive ecosystem was previously disturbed without a development permit this exemption does not apply.
2. Minor additions to existing buildings or structures to a cumulative maximum of 25 percent of the original ground floor area, provided that the addition is not situated closer to the environmentally sensitive feature for which the development permit area has been identified, than the existing building or structure.
3. Repair, maintenance, or alteration of existing legal buildings, structures or utilities except for shoreline protection structures, provided the footprint of the building is not expanded (a building permit may still be required).
4. A second storey addition, excluding cantilevered construction, to a legally sited structure, provided the second storey addition is within the existing footprint of the existing structure.
5. A single trail within this development permit area, subject to the following:
 - a) the trail provides the most direct route of feasible passage through the development permit area;
 - b) the location is chosen to require a minimum amount of vegetation removal or disturbance, where no rare plants will be disturbed or otherwise impacted, and where there is limited excavation and removal of native soils;
 - c) the ground is stable, i.e erodible stream banks or other erosion prone areas must be avoided;
 - d) no motorized vehicles are permitted;

- e) the trail is a maximum of 1.5 metres in width;
 - f) no trees, which are greater than 5.0 metres in height and no trees with a diameter at breast height of 10.0 centimetres or more are being removed; limbing, pruning and topping of trees should be done instead; and,
 - g) the trail's surface is pervious but may be constructed with materials that limit erosion and bank destabilization (certain structures may require a building permit).
6. The planting of trees, shrubs, or groundcovers for the purpose of enhancing the habitat values and/or soil stability within the development permit area provided the planting is carried out in accordance with the guidelines provided in 'Develop with Care: Environmental Guidelines for Urban and Rural Land Development in British Columbia', published by Ministry of Environment, or any subsequent editions.
 7. Gardening and yard maintenance activities within an existing landscaped area, such as lawn mowing, tree and shrub pruning, vegetation planting and minor soil disturbance that do not alter the general contours of the land. For clarity, this exemption does not apply to retaining walls and anything that is considered a structure as defined by the current zoning bylaw.
 8. The small-scale, manual removal of non-native invasive plants or noxious weeds or planting of non-invasive, native vegetation on a small scale conducted in accordance with best practices such as the Invasive Plant Council of BC's 'Grow Me Instead' publication.
 9. Removal of trees deemed hazardous by a certified Arborist or Registered Professional Forester that pose an imminent threat to buildings or life safety. Removal of hazardous trees that also contain an eagle or heron nest is exempt only if a permit under the *Wildlife Act* has been obtained.
 10. The construction of a small accessory building or structure if all the following apply:
 - a) the building or structure is located within an existing landscaped area;
 - b) no native trees with a diameter at breast height of 20 centimetres or greater are removed;
 - c) there is no permanent foundation;
 - d) the building or structure is located a minimum of 10 metres from the natural boundary of the sea or, where the bank has a slope greater than 3:1, 10 metres from the top of the bank; and
 - e) the total area of the small accessory building or structure is less than 10 square metres.
 11. Subdivision where the following criteria is met:
 - a) minimum lot sizes will be met exclusive of the sensitive ecosystem;
 - b) no development activities including grading, clearing, trenching, or installation of pipes, relating to the creation of all lots will occur within the sensitive ecosystem; and
 - c) where a covenant is registered to protect the sensitive ecosystem or ecosystems in a manner that is consistent with the applicable development permit area guidelines.
 12. Subdivision involving only lot line adjustment. For lot line adjustment to be exempt there must be sufficient developable area outside the development permit area as confirmed by the

Regional District, BC Land Surveyor, or Registered Professional Biologist, and there are no works proposed within the development permit area.

13. The activity is part of a farm operation as defined by the *Farm Practices Protection (Right to Farm) Act*; is a permitted farm use as defined in Section 2(2) of the *Agricultural Land Reserve Use, Subdivision, and Procedures Regulations*; and the lands are assessed as ‘farm’ under the *BC Assessment Act*. The farm operation of land clearing is only exempt from the requirement of a development permit if conducted in accordance with a current Environmental Farm Plan (less than five years old); otherwise, land clearing as part of a farm operation is not exempt. Note that other provincial legislation such as the *Waste Management Act* and the *Water Sustainability Act* may apply to farm operation activities.
14. Emergency procedures to prevent, control, or reduce erosion, or other immediate threats to life and property including:
 - a) emergency flood or protection works;
 - b) clearing of an obstruction from bridge, culvert, or drainage flow; repairs to bridges and safety fences;
 - c) any emergency works to be undertaken in accordance with the Provincial *Water Sustainability Act* and *Wildlife Act*, and the Federal *Fisheries Act*.

Notwithstanding the above, emergency actions for flood protection and clearing of obstructions by anyone other than the Regional District or Ministry must be reported to the Regional District and applicable Ministry immediately to secure exemption under this provision. Note that once the emergency has passed, a development permit may be required for remediation or permanent protection works.

15. Works conducted and/or approved by the Department of Fisheries and Oceans and/or Ministry of Environment with respect to trail construction, stream enhancement, fish and wildlife habitat restoration and in-stream works as defined by Section 11 of the *Water Sustainability Act*.
16. Works conducted by the Regional District or its agents where appropriate measures have been undertaken to satisfy the applicable development permit area guidelines as determined by the Regional District.
17. All forest management activities on lands subject to the *Forest Act* or *Private Managed Forest Land Act* and classified as ‘forest lands’ on the property assessment.

GUIDELINES

1. If development or alteration of land is proposed within the development permit area, it shall be located where it will cause the least impact on the sensitive ecosystem. It should be demonstrated that locating development entirely outside of the development permit area has been considered, and a description of why that is not being proposed should be provided. It should be demonstrated that variances to minimize development in the development permit area have been obtained or considered.
2. An assessment must be prepared by a Registered Professional Biologist with the objectives of identifying sensitive biophysical features on or near the property and providing recommendations and conditions for development to avoid or mitigate impacts to these

5.1.2 Sensitive Ecosystems Development Permit Area

features. The assessment should list the guidelines in this development permit area with an explanation of how the proposed development is consistent with them (or an explanation of how a guideline is not applicable) and should indicate on a site plan the areas for yard and driveway and areas to remain free from development.

3. Existing native vegetation should be retained wherever possible to minimize disruption to habitat and maintain ecological processes that support ecosystem function, wildlife ecology, and unique ecosystems. These include, but are not limited to:
 - a) vegetation, trees, snags and root systems;
 - b) rare and uncommon species and plant communities;
 - c) soils and soil conditions (moisture, nutrients and permeability);
 - d) bird and other wildlife and their habitats, such as nesting and breeding areas;
 - e) wildlife habitat, including but not limited to wildlife breeding areas as well as nesting and perch trees; and
 - f) topography and relative orientation of features on neighbouring properties.
4. Mitigation measures that should be considered in the biological assessment include but are not limited to:
 - a) maintenance of an effective visual and sound (natural vegetated) buffer around nesting trees;
 - b) minimization of vegetation removal;
 - c) maintenance of linkages with adjacent sensitive ecosystems to minimize habitat fragmentation and maintain wildlife corridors; and
 - d) timing of construction to minimize potential impacts.
5. Where the applicant's biologist recommends revegetation and/or enhancement works within the development permit area, the Regional District may require the applicant to submit a landscaping plan and security deposit equal to the total estimated costs of all materials and labour as determined by a Landscape Architect or other qualified professional.
6. Where the applicant's biologist recommends specific areas that must remain free from development:
 - a) the Regional District may require a Section 219 covenant to be prepared at the applicant's expense, to the satisfaction of the Regional District, to ensure that the identified areas remain free from development; and
 - b) prior to construction commencing, the installation of temporary fencing or flagged stakes marking the protection area is required to avoid encroachment within the areas to be protected through to the completion of the development.
7. The applicant's biologist may be required to provide confirmation to the Regional District that the property has been developed in accordance with the biologist's recommendations.

Guidelines Related to Rainwater Management and Protection of Development from Hazardous Conditions

8. Where there is a slope greater than 30 percent over a minimum horizontal distance of 10 metres, an assessment report prepared by a Professional Engineer with experience in geotechnical engineering may be required to assist in determining what conditions or requirements shall be included in the development permit so that proposed development is protected from the hazard and no increase in hazard is posed to existing development. The geotechnical report will form part of the development permit terms and conditions, and may include registration of a Section 219 covenant, prepared at the applicant's expense and to the satisfaction of the Regional District.
9. Development or subdivision of land should be designed to:
 - a) replicate the function of a naturally vegetated watershed;
 - b) maintain the hydraulic regime of surface and groundwater and pre-development flow rates;
 - c) not interfere with groundwater recharge; and
 - d) not introduce or remove materials where it would cause erosion of or the filling in of natural watercourses and/or wetlands.
10. The use of rain gardens, vegetated swales, a reduction in impervious surfaces, and other methods for managing rainwater on site should be included in all development proposals considered in this DPA.

5.1.3 Eagle and Heron Nesting Trees Development Permit Area

Information Note: the designation of this development permit area and description of the special conditions or objectives that justify the designation are located in the applicable official community plans.

APPLICABILITY

A development permit is required for the following activities wherever they occur within this development permit area, unless specifically exempted:

1. removal, alteration, disruption or destruction of natural features, including plants, trees and shrubs;
2. disturbance of soils, including grubbing, scraping and the removal of top soils;
3. construction or erection of buildings and structures;
4. creation of non-structural impervious or semi-pervious surfaces; and
5. subdivision of land as defined in the *Land Title Act* or *Strata Property Act*.

EXEMPTIONS

The following activities are exempt from any requirement for a development permit:

1. Development or alteration of land to occur outside the designated development permit area, as determined by a BC Land Surveyor, Registered Professional Biologist, or by the Regional District.
2. The landowner has offered and entered into a restrictive covenant to maintain an acceptable no disturbance buffer as determined by a registered professional biologist.
3. A Registered Professional Biologist with relevant experience has confirmed in writing that no Bald Eagle or no Great Blue Heron has established a nest and is present during the breeding and nesting season of the past five years. In general terms, this is from January to September for Great Blue Herons; and January to September for Bald Eagles.
4. Removal, trimming or alteration of vegetation other than the nest tree; onsite sewage disposal system installations and well drilling within the nest tree development permit area is permitted without a development permit where:
 - a) the activity is conducted entirely outside of the nesting season which is from January 15 to September 15 for Pacific Great Blue Herons and January 1 to September 1 for Bald Eagles, or
 - b) a Registered Professional Biologist with relevant experience has confirmed in writing that the activity will not negatively impact the nest tree, or its associated Great Blue Herons or Bald Eagles.
5. Subdivision involving only lot line adjustment or lot consolidation. For lot line adjustment to be exempt there must be sufficient developable area outside the development permit area as confirmed by the Regional District, BC Land Surveyor, or Registered Professional Biologist, and there are no works proposed within the development permit area.
6. Removal of trees deemed hazardous by a certified Arborist or Registered Professional Forester that pose an immediate threat to buildings or life safety. Removal of hazardous trees that also

5.1.3 Eagle and Heron Nesting Trees Development Permit Area

contain an eagle or heron nest is exempt only if a permit under the *Wildlife Act* has been obtained.

7. The small-scale, manual removal of non-native invasive plants or noxious weeds or planting of non-invasive, native vegetation on a small scale conducted in accordance with best practices such as the Invasive Plant Council of BC's 'Grow Me Instead' publication.
8. Emergency procedures to prevent, control, or reduce erosion, or other immediate threats to life and property including:
 - a) emergency flood or protection works;
 - b) clearing of an obstruction from bridge, culvert, or drainage flow; repairs to bridges and safety fences;
 - c) any emergency works to be undertaken in accordance with the Provincial *Water Sustainability Act* and *Wildlife Act*, and the Federal *Fisheries Act*.

Notwithstanding the above, emergency actions for flood protection and clearing of obstructions by anyone other than the Regional District or Ministry must be reported to the Regional District and applicable Ministry immediately to secure exemption under this provision. Note that once the emergency has passed, a development permit may be required for remediation or permanent protection works.

9. Works conducted and/or approved by the Regional District, Department of Fisheries and Oceans and/or Ministry of Environment with respect to trail construction, stream enhancement, fish and wildlife habitat restoration and in-stream works as defined by Section 11 of the *Water Sustainability Act*, and where they have been made aware of the eagle or heron nest.
10. All forest management activities on lands subject to the *Forest Act* or *Private Managed Forest Land Act* and classified as 'Forest Lands' on the property assessment.
11. Works conducted by the Regional District or its agents where appropriate measures have been undertaken to satisfy the applicable development permit area guidelines as determined by the Regional District.

GUIDELINES

Development permits shall be issued in accordance with the following:

1. Development shall be located where it will cause the least impact to the nesting activity of eagles or herons. It should be demonstrated that locating development entirely outside of the development permit area has been considered, and a description of why that is not being proposed should be provided.
 - a) An assessment must be prepared by a Registered Professional Biologist with relevant experience to assess the potential impact of the proposed development on the function of the nest tree and development or land alteration within the development permit area on the subject property. The report should include, but is not limited to, the following:
 - b) definition of the study area and the proposed activities in relation to the nesting tree, including a map to identify the location including geographic coordinates of nesting tree or trees, the development permit area, and proposed or existing buildings and structures;

5.1.3 Eagle and Heron Nesting Trees Development Permit Area

- c) identification of the breeding season;
 - d) assessment of the impacts of the proposed activities in relation to the resident birds (Bald Eagle or Great Blue Heron) and prescribe appropriate measures to preserve, protect, restore or enhance the function of the nesting tree area and any alteration of the development permit area on the subject property;
 - e) recommendations on how to mitigate negative impacts during and after construction, if permitted under the *Wildlife Act*, to protect the long term integrity of the nesting habitat; and
 - f) reference to ‘Guidelines for Ecosystem and Species Protection’ and/or ‘Guidelines for Raptor Conservation during Urban and Rural Land Development in BC’ found in ‘Develop with Care: Environmental Guidelines for Urban and Rural Land Development in British Columbia’ published by the Province of BC, or any subsequent editions.
2. The recommendations within the assessment report will form part of the development permit terms and conditions, which may include registration of a Section 219 covenant, prepared at the applicant’s expense, to the satisfaction of the Regional District.
 3. To avoid encroachment within the area to be protected as identified in the Assessment Report, prior to construction commencing and through to the completion of the development, installation of temporary fencing or flagged stakes is required at a distance from the nesting tree as prescribed in the Assessment Report.
 4. The applicant’s biologist may be required to provide confirmation to the Regional District that the property has been developed in accordance with their recommendations.

5.1.4 Aquifers Development Permit Area

Information Note: the designation of this development permit area and description of the special conditions or objectives that justify the designation are located in the applicable official community plans.

APPLICABILITY

A development permit is required for the following activities wherever they occur within this development permit area, unless specifically exempted:

1. alteration of land, disturbance of soils, including grubbing, scraping and the removal of top soils;
2. construction, alteration, or erection of buildings and structures;
3. creation of non-structural impervious or semi-pervious surfaces;
4. subdivision of land as defined in the *Land Title Act* or *Strata Property Act*; and
5. excavation or sub-surface disturbance in the sub-area defined as ‘risk of artesian conditions’.

EXEMPTIONS

The following activities are exempt from any requirement for a development permit:

1. Construction, renovation, repair or addition to a single dwelling unit, duplex dwelling unit, secondary suite, building or structure accessory to residential use including a driveway and except for excavation of a depth greater than 1.5 metres in an area with ‘risk of artesian conditions’.
2. Construction of or additions to a building or structure that do not require a building permit.
3. Digging of observation holes for percolation testing under supervision of a Registered Onsite Wastewater Practitioner or Professional Engineer, and digging of test pits for geotechnical investigation under supervision of a Professional Engineer.
4. Onsite wastewater disposal system installation meeting the requirements of the *Sewerage System Regulation* of the *Public Health Act*.
5. Subdivision of land within Cedar Village Centre and South Wellington Light Industrial & Commercial Area as designated in the Electoral Area A Official Community Plan, except for intensive residential within the Cedar Main Street Village Plan area (intensive residential is defined in that plan).
6. Subdivision of land where a maximum of three lots are proposed, including the remainder, and where the subject property:
 - a) in Electoral Area H has a ‘low’ vulnerability as identified in the Official Community Plan or;
 - b) in Electoral Area G does not have a development subclass of ‘heavy’ nor a vulnerability class of ‘high’ or a combination of ‘heavy’ or ‘high’ as identified in the Official Community Plan.

5.1.4 Aquifers Development Permit Area

7. Subdivision of land where the application is limited to lot line adjustment and no additional lots are created.
8. Subdivision of land where each lot has an approved connection to a community water system, except for within Cassidy Village Centre.
9. The activity is part of a farm operation as defined by the *Farm Practices Protection (Right to Farm) Act*, is a permitted farm use as defined in Section 2(2) of the *Agricultural Land Reserve Use, Subdivision, and Procedures Regulations*, and the lands are assessed as ‘farm’ under the *BC Assessment Act*. The farm operation of land clearing is only exempt from the requirement of a development permit if conducted in accordance with a current Environmental Farm Plan (less than 5 years old); otherwise, land clearing as part of a farm operation is not exempt. Note that other provincial legislation such as the *Waste Management Act* and the *Water Sustainability Act* may apply to farm operation activities.
10. All forest management activities on lands subject to the *Forest Act* or *Private Managed Forest Land Act* and classified as ‘Forest Lands’ on the property assessment.
11. Works conducted by the Regional District or its agents where appropriate measures have been undertaken to satisfy the applicable development permit area Guidelines as determined by the Regional District.

GUIDELINES

Development permits shall be issued in accordance with the following:

1. The use or disposal of substances or contaminants that may be harmful to area aquifers is discouraged and steps must be taken to ensure the proper disposal of such contaminants.
2. A report must be prepared by a Professional Engineer or Geoscientist with experience in hydrogeology. The report should follow any applicable checklist of the Regional District for preparation of hydrogeological assessment reports and should also include, but is not limited, to the following:
 - a) definition of the study area and the relationship of the proposed development to the protected aquifer and known recharge areas, including map(s) indicating community water well locations;
 - b) capture zone analysis for existing and proposed new wells;
 - c) an assessment of the ability of the aquifer to accommodate additional groundwater demand proposed by the development, which shall include the anticipated water demand of the proposed uses based on the development potential of the subject property based on the current zoning;
 - d) identification of potential impacts on adjacent properties and land uses; and
 - e) recommendations for measures required to ensure the quality and quantity of water in the aquifer is protected.
3. The use of permeable paving and other methods to reduce rainwater runoff are encouraged.

4. Where a proposed development will include any of the purposes or activities listed in Schedule 2 of the Contaminated Sites Regulation, (B.C. Reg. 375/96), the report prepared by a Professional Engineer or Geoscientist with experience in hydrogeology (as described in Guideline 2) shall be required to confirm the protection of the aquifer in relation to the intended uses. In this case, the professional report should additionally include the following:
 - a) as part of the map(s) described in Guideline 2a., also indicate: site location of activities listed in abovementioned regulation, all well locations (abandoned or operational, proposed or existing above ground or underground fuel storage tanks, and underground utilities, such as water, sanitary, and storm water drainage or natural gas lines;
 - b) assess the potential for contamination and the expected results should a spill occur;
 - c) identify appropriate site-specific groundwater protection measures;
 - d) address site design, and best management practices for site drainage, sewage disposal and hazardous material use, handling, storage, disposal and spill response; and
 - e) provide recommendations, a conclusion and a reference site layout plan.
5. A rainwater management plan prepared by a Professional Engineer may be required to ensure that the discharge of any treated effluent and rainwater does not negatively affect groundwater quality. The plan must include recommendations on how to minimize the risk of deleterious substances entering the groundwater.
 - a) Treated effluent and diverted rainwater collection and discharge systems on commercial, industrial, multi-residential, and other developments where there is potential for silt and petroleum-based contaminants to enter a watercourse or infiltrate into the ground must be directed through an appropriately sized and engineered sediment, oil, water and grease separator or other engineered solution. Examples of uses to which this guideline applies includes uses such as vehicle and machinery storage, cleaning and maintenance, and public parking areas.
 - b) The engineer must provide an appropriate maintenance schedule.
6. Development or subdivision of land should be designed to:
 - a) replicate the function of a naturally vegetated watershed;
 - b) not interfere with groundwater recharge;
 - c) maintain the hydraulic regime of surface and groundwater and pre-development flow rates which includes no net increase in peak rainwater run-off from the land to adjoining lands.
7. Where a proposed development is within a sub-area “risk of artesian conditions” as identified in the applicable official community plan:
 - a) the professional report shall determine the depth of the overlying till aquitard, and provide recommendations for its protection during excavation, well drilling, and construction; and
 - b) wells must be drilled by a registered well driller who is qualified to control artesian flow.
8. Where a proposed development is within the well protection area or well capture zone of a community water system, the professional report must refer to the relevant well protection

5.1.4 Aquifers Development Permit Area

plan and provide recommendations for the development to ensure mitigation of any potential risk to the community water source.

9. All development that proposes a site, facility, or premise where municipal solid waste or recyclable materials will be managed must be conducted in accordance with RDN Waste Stream Management Licensing Bylaw No. 1386, 2004 as amended or replaced from time to time.
10. Recommendations within the professional report(s) will form part of the development permit terms and conditions, and may include registration of a Section 219 covenant, prepared at the applicant's expense and to the satisfaction of the Regional District. Where a maintenance schedule for a sediment, oil, water and grease separator is recommended, a commitment to the maintenance schedule may be included in the covenant.
11. Developments that are found to pose detrimental impact(s) on either the quality or quantity of groundwater which cannot be adequately mitigated shall not be supported by the Regional District.

5.1.5 Marine Coast Development Permit Area

Information Note: the designation of this development permit area and description of the special conditions or objectives that justify the designation are located in the applicable official community plans.

APPLICABILITY

A development permit is required for the following activities wherever they occur within this development permit area, unless specifically exempted:

1. removal, alteration, disruption or destruction of vegetation, including trees, plants and shrubs;
2. disturbance of soils, including grubbing, scraping and the removal of top soils;
3. construction or erection of buildings and structures;
4. creation of non-structural impervious or semi-pervious surfaces; and
5. subdivision of land as defined in the *Land Title Act* or *Strata Property Act*.

EXEMPTIONS

The following activities are exempt from any requirement for a development permit:

1. Development or alteration of land to occur outside the designated development permit area, as determined by a BC Land Surveyor or by the Regional District.
2. Repair, maintenance, or alteration of existing legal buildings, structures or utilities except for shoreline protection structures, provided the footprint of the building is not expanded (a building permit may still be required). For clarity, repair, maintenance, alteration or reconstruction of shoreline protection works such as riprap and stacked rocks, requires a development permit whether or not they meet the definition of 'structure' in other bylaws of the Regional District.
3. Minor additions to existing buildings or structures to a cumulative maximum of 25 percent of the original ground floor area, provided that the addition is located on the side or part of the building or structure most distant from the foreshore.
4. A second storey addition, excluding cantilevered construction, to a legally sited structure, provided the second storey addition is within the existing footprint of the existing structure.
5. Repair and maintenance of existing roads, driveways, paths and trails, provided there is no expansion of the width or length of the road, driveway, path or trail, and no creation of additional impervious surfacing, including paving, asphaltting or similar surfacing.
6. Construction of a fence so long as no native trees with a diameter at breast height of 20 centimetres or greater are removed and the disturbance of native vegetation is restricted to 0.5 metres on either side of the fence.
7. Gardening and yard maintenance activities within an existing landscaped area, such as lawn mowing, tree and shrub pruning, vegetation planting and minor soil disturbance that do not alter the general contours of the land.

5.1.5 Marine Coast Development Permit Area

8. The construction of a small accessory building or structure such as a pump house, gazebo, deck, patio, garden shed or play house if all the following apply;
 - a) the building or structure is located within an existing landscaped area;
 - b) no native trees with a diameter at breast height of 20 centimetres or greater are removed;
 - c) there is no permanent foundation
 - d) the building or structure is located a minimum of 10 metres from the natural boundary of the sea or, where the bank has a slope greater than 3:1, 10 metres from the top of the bank; and
 - e) the total area of the small accessory building or structure is less than 10 square metres.
9. Removal of trees deemed hazardous by a certified Arborist or Registered Professional Forester that pose an imminent threat to buildings or life safety. Removal of hazardous trees that also contain an eagle or heron nest is exempt only if a permit under the *Wildlife Act* has been obtained.
10. The small-scale, manual removal of non-native invasive plants or noxious weeds or planting of non-invasive, native vegetation on a small scale conducted in accordance with best practices such as the Invasive Plant Council of BC's 'Grow Me Instead' publication.
11. Works conducted and/or approved by the Regional District, Department of Fisheries and Oceans and/or Ministry of Environment with respect to trail construction, stream enhancement, fish and wildlife habitat restoration and in-stream works as defined by Section 11 of the *Water Sustainability Act*.
12. Works conducted by the Regional District or its agents where appropriate measures have been undertaken to satisfy the applicable development permit area guidelines as determined by the Regional District.
13. Subdivision involving only lot line adjustment or lot consolidation. For lot line adjustment to be exempt there must be sufficient developable area outside the development permit area as confirmed by the Regional District, BC Land Surveyor, or Registered Professional Biologist, and there are no works proposed within the development permit area.

GUIDELINES

General Guidelines

1. Development within the development permit area should be limited and not negatively impact the ecological health of the immediate area, disrupt coastal sediment transport processes, or impede public access along the shore. It should be demonstrated that locating development entirely outside of the development permit area has been considered, and a description of why that is not being proposed should be provided. It should be demonstrated that variances to minimize development in the development permit area have been obtained or considered.
2. An assessment must be prepared by a Registered Professional Biologist with the objectives of identifying sensitive biophysical features on or near the property and providing recommendations and conditions for development to avoid or mitigate impacts to these

features. The assessment should list the guidelines in this development permit area with an explanation of how the proposed development is consistent with them (or an explanation of how a guideline is not applicable) and should indicate on a site plan areas for yard and driveway and areas to remain free from development.

3. Existing native vegetation should be retained wherever possible to minimize disruption to habitat and to protect against erosion:
 - a) Dune grass is particularly sensitive to foot traffic and often keeping foot traffic away through fencing or signage can result in regeneration in short time periods. Replanting of dune grass and associated plants where it has been previously disturbed may be a condition of a development permit.
 - b) Coniferous trees provide important perches for eagles, and older trees may be used by eagles for nests. It is important that some trees are retained or replanted within and close to the development permit area when properties are developed, even if the trees are young.
 - c) Trees and shrubs to be retained should be clearly marked prior to development, and temporary fencing installed at the drip line to protect them during clearing, grading, storage of fill or building materials, and other development activities.
 - d) Temporary fencing at a prescribed distance from the natural boundary or top of bank should be required to protect the shoreline vegetation.
4. New, or additions to, upland buildings and structures should be located and designed to avoid the need for shore protection works throughout the life of the building or structure. Only if all options to locate and design without the need for shore protection measures are exhausted should such works be considered.
5. Shore protection measures shall not be allowed for the sole purpose of reducing the setback pursuant to the Floodplain Bylaw or for reclaiming land lost due to erosion.
6. Where shoreline protection works are proposed they shall be designed by a Professional Engineer and:
 - a) be limited to that necessary to prevent damage to existing structures or established uses on adjacent upland;
 - b) be the ‘softest’ possible shore protection measure that will still provide satisfactory protection;
 - c) not be expected to cause erosion or other physical damage to adjacent or down-current properties;
 - d) address compatibility with any adjacent shore protection works; and
 - e) be in compliance with the Regional District’s Marine Retaining Wall Policy B1-09.
7. Where a geotechnical report is required, it will form part of the development permit terms and conditions, which may include registration of a Section 219 covenant, prepared at the applicant’s expense and to the satisfaction of the Regional District.
8. Where protection from erosion is proposed as either new works or replacement, every effort will be made to design shoreline protection in accordance with the *Green Shores* programs of the Stewardship Centre of BC. These programs provide resources for, and examples of, shoreline

erosion protection involving creation or maintenance of low-angle slopes allowing for dissipation of wave energy, retaining native plants and habitat, and providing a natural appearance. Some *Green Shores* approaches rely on use of the beach below the natural boundary, which requires permission from the Province.

9. Where erosion protection works are proposed below the natural boundary, they should not obstruct public access along the foreshore or beach, and must be authorized by the Provincial Crown as owner of that land.
10. Heavy equipment shall not be permitted on the beach unless existing conditions do not permit upland access and, if required, mitigation methods acceptable to the Regional District shall be identified as part of the application. Procedures shall be in compliance with the Regional District's Marine Retaining Wall Policy B1-09, as amended or replaced from time to time. For commercial and multi-family developments, the *Green Shores for Coastal Developments* program of the Stewardship Centre of BC should be reviewed and referenced, and every effort made to design the development in accordance with its recommendations and best practices.
11. Entirely 'hard' structural shore protection measures such as concrete walls, lock block, or stacked rock (riprap), may be considered as a last resort only when a geotechnical and biophysical analysis demonstrates that:
 - a) the erosion is not being caused by upland conditions, such as the loss of vegetation and drainage associated with upland development;
 - b) all possible on site drainage solutions by directing drainage away from the shoreline edge have been exhausted;
 - c) Green Shores non-structural or structural measures are not feasible or not sufficient to address the stabilization issues;
 - d) it is not feasible to instead construct a retaining wall that meets the zoning bylaw setback;
 - e) the shore protection measure is designed so that neighbouring properties are not expected to experience additional erosion; and
 - f) all shore protection structures are installed upland of the present natural boundary of the sea.
12. Where the installation of a hydrothermal and geoexchange unit is proposed, the Regional District will require the applicant to provide a report by a Registered Professional Biologist with experience in marine ecology, to assess the potential impact of the proposed installation on the marine environment, public users of the foreshore, the anchoring of vessels, and First Nation shellfish harvesting, and provide recommendations to restore or enhance those areas impacted by the proposed development.
13. Where the applicant's biologist or other qualified professional recommends revegetation and/or enhancement works within the development permit area, the Regional District may require the applicant to submit a landscaping and security deposit equal to the total estimated costs of all materials and labour as determined by a Landscape Architect or other qualified professional.
14. The applicant may be required to provide confirmation to the Regional District that the property has been developed in accordance with the recommendations of the biologist or engineer, as applicable.

Guidelines Applicable to Subdivisions and New Development

15. Subdivisions should be designed so that the new lots will not require shore protection measures in order for useable, safe building sites to be created above the year 2100 flood construction level when considering sea level rise.
16. New development on steep slopes or bluffs shall be set back sufficiently from the top of the bluff to ensure that shore protection measures will not be necessary during the life of the structure, as demonstrated by a geotechnical analysis.
17. New driveways, parking lots, and wastewater disposal systems should not be located in the development permit area. If such a location cannot be avoided, the encroachment into the development permit area must be minimized, and the design and construction of the road, parking lot or wastewater disposal system be supervised by a qualified professional to ensure that the objectives and guidelines of the development permit area are met. These works may be required to be completed prior to final approval of the subdivision.

Guidelines Applicable to Vegetation Management, Restoration and Enhancement

18. If the area has been previously cleared of native vegetation or where clearing is proposed, replanting should be required in accordance with these guidelines and according to the recommendations of a Registered Professional Biologist. Where it is not practical to replace all vegetation that is or has been removed, replanting should be focused on the areas of highest ecological value such as foreshore dune grass ecosystems, trees suitable for eagle perching, or other areas identified in the biophysical assessment.
19. Vegetation species used in replanting, restoration or enhancement should be salt and wind tolerant, and selected to suit the soil, light and groundwater conditions of the site, should be native to the area, and be selected for erosion control and/or wildlife habitat values as needed. A minor amount of suitably adapted, non-invasive, non-native vegetation may also be considered acceptable subject to supportive recommendations in a biophysical report.
20. All replanting should be maintained by the property owner for a minimum of two years from the date of completion of the planting. This may require removal of invasive, non-native weeds (e.g., Himalayan Blackberry, Scotch Broom, English Ivy) and irrigation. Unhealthy, dying or dead stock should be replaced at the owner's expense within that time in the next regular planting season.

Guidelines Applicable to Beach Nourishment and Upland Fill

21. Fill on land above the natural boundary greater than 10 cubic metres in volume should be considered only when necessary to assist in the enhancement of the natural shoreline's stability and ecological function. Such fills should be located, designed, and constructed to protect shoreline ecological functions and ecosystem-wide processes, including channel migration, and the Regional District may require a sediment and erosion plan prepared by a qualified professional.
22. Fill below (seaward of) the natural boundary should be considered only when necessary to assist in the enhancement of the natural shoreline's stability and ecological function, typically as part of a beach nourishment design. This would also require permission from the Province.

Guidelines Applicable to Commercial and Industrial Development

23. New boating facilities that provide moorage shall not be constructed unless access is available to adequate and convenient facilities for pump-out of holding tanks.
24. New boat maintenance and repair facilities shall be designed, located and operated in a way that ensures there will be no discharge of toxic materials from boats (fuels, oils, maintenance by-products, etc.)
25. In order to minimize the impact on aquatic life, lighting of commercial and industrial developments built over the water surface should be kept to the minimum necessary for safety and visibility. Light fixtures on such sites should focus light on the area to be illuminated and avoid spillage of light into other areas. Fixtures should not result in glare when viewed from areas that overlook the sea. Low-glare fixtures with a high-cutoff angle should be used. Full-spectrum fixtures are preferred. Neon lighting should not be used outside buildings.
26. Signs on commercial and industrial developments built over the water surface should not move or be audible and should not incorporate lighting that moves or flashes or gives the impression of doing so.

Guidelines Applicable to Boat Launch Facilities or Ramps

27. Boat launch ramps are the least desirable of all water access structures and may only be located on stable, non-erosional banks where a minimum amount of substrate disturbance or stabilization is necessary. Ramps should be kept flush with the slope of the foreshore to minimize interruption of natural geo-hydraulic processes. The ramp width should be minimized, and paved strips versus a full concrete pad is preferable. Development Permit applications must demonstrate all applicable provincial and federal guidelines have been followed and approvals are in place.

5.1.6 Hazard Lands Development Permit Area

Information Note: the designation of this development permit area and description of the special conditions or objectives that justify the designation are located in the applicable official community plans.

APPLICABILITY

A development permit is required for the following activities unless specifically exempt:

1. alteration of land, placement of fill, disturbance of soils, including grubbing, scraping and removal of top soils;
2. construction or erection of buildings and structures;
3. creation of non-structural impervious or semi-pervious surfaces; and,
4. subdivision of land.

EXEMPTIONS

The following activities are exempt from requiring a development permit:

1. Development or alteration of land to occur outside the designated development permit area, as determined by a BC Land Surveyor or by the Regional District.
2. Where there is no flooding or steep slope hazard, confirmation of which may require a letter from a Professional Engineer.
3. The construction of buildings and structures in accordance with the RDN Floodplain Management Bylaw No. 1469, 2006 or a subsequent Floodplain Bylaw, where there is no proposed land alteration, placement of fill, or modification to land within the floodplain outside of the building footprint beyond minor soil disturbance resulting from normal construction practices.
4. Where a geotechnical report for a proposed building or structure is provided to the building inspector and a s.219 covenant regarding building on the land is registered on the title to the land, in circumstances where there is no proposed alteration of land, including placement of fill, other than minor soil and vegetation disturbance of a type and to an extent that is usual in normal construction practices.
5. On a lot where the hazard is not due to a steep slope, a second storey addition to an existing structure provided the building footprint remains the same.
6. The construction of a small accessory building or structure if all the following apply:
 - a) the building is located within an existing landscaped area;
 - b) no native trees with a diameter at breast height of 20 centimetres or greater are removed;
 - c) is moveable by being not directly affixed to the ground;
 - d) the building is located a minimum of 10 metres from the high water mark of a watercourse or waterbody or, where a slope greater than 3:1, 10 metres from the top of the slope; and

- e) the total area of the small accessory building is less than 10 metres square.
- 7. The construction of a fence.
- 8. In the case of an application to subdivide, a development permit is not required where:
 - a) minimum lot areas are met exclusive of the development permit area; and
 - b) no development activities (such as grading, clearing, trenching, installation of pipes, etc.) relating to the creation of lots or provision of services for those lots will occur within the development permit area.
- 9. Subdivision involving only lot line adjustment or lot consolidation. For lot line adjustment to be exempt there must be sufficient developable area outside the development permit area as confirmed by the Regional District, BC Land Surveyor, or Professional Engineer, and there are no works proposed within the development permit area.
- 10. Removal of trees deemed hazardous by a certified Arborist or Registered Professional Forester that pose an imminent threat to buildings or life safety. Removal of hazardous trees that also contain an eagle or heron nest is exempt only if a permit under the *Wildlife Act* has been obtained.
- 11. The small-scale, manual removal of non-native invasive plants or noxious weeds or planting of non-invasive, native vegetation on a small scale conducted in accordance with best practices such as the Invasive Plan Council of BC's 'Grow Me Instead' publication.
- 12. The activity is part of a farm operation as defined by the *Farm Practices Protection (Right to Farm) Act*, is a permitted farm use as defined in Section 2(2) of the *Agricultural Land Reserve Use, Subdivision, and Procedures Regulations*, and the lands are assessed as 'farm' under the *BC Assessment Act*. The farm operation of land clearing is only exempt from the requirement of a development permit if conducted in accordance with a current Environmental Farm Plan (less than five years old); otherwise, land clearing as part of a farm operation is not exempt. Note that other provincial legislation such as the *Waste Management Act* and the *Water Sustainability Act* may apply to farm operation activities.
- 13. Emergency procedures to prevent, control, or reduce erosion, or other immediate threats to life and property including:
 - a) emergency flood or protection works;
 - b) clearing of an obstruction from bridge, culvert, or drainage flow; repairs to bridges and safety fences;
 - c) any emergency works to be undertaken in accordance with the Provincial *Water Sustainability Act* and *Wildlife Act*, and the federal *Fisheries Act*.

Notwithstanding the above, emergency actions for flood protection and clearing of obstructions by anyone other than the Regional District or Ministry must be reported to the Regional District and applicable Ministry immediately to secure exemption under this provision. Note that once the emergency has passed, a development permit may be required for remediation or permanent protection works.

- 14. Digging of observation holes for percolation testing under supervision of a Registered Onsite Wastewater Practitioner or Professional Engineer, and digging of test pits for geotechnical investigation under supervision of a Professional Engineer.

5.1.6 Hazard Lands Development Permit Area

15. Works conducted and/or approved by the Regional District, Department of Fisheries and Oceans and/or Ministry of Environment with respect to trail construction, stream enhancement, fish and wildlife habitat restoration and in-stream works as defined by Section 11 of the *Water Sustainability Act*.
16. All forest management activities on lands subject to the *Forest Act* or *Private Managed Forest Land Act* and classified as 'Forest Lands' on the property assessment.
17. Works conducted by the Regional District or its agents where appropriate measures have been undertaken to satisfy the applicable development permit area guidelines as determined by the Regional District.

GUIDELINES

General Guidelines

1. An assessment report prepared by a Professional Engineer or Geoscientist with experience in geotechnical engineering, geohazard assessment or river hydrology, as applicable, shall be required to assist in determining what conditions or requirements shall be included in the development permit so that the proposed development is protected from the hazard, and no increase in hazard is posed to existing development on or near the subject property.
 - a) The assessment report should include a site plan identifying areas susceptible to the flooding, erosion or steep slope hazard, location of watercourses, existing natural vegetation, on site topography, and the location of the proposed development.
 - b) The assessment report must include a statement from the Professional Engineer that states in their opinion that the property is safe for the intended use.
 - c) The assessment report will form part of the development permit terms and conditions, and which may include registration of a Section 219 covenant, prepared at the applicant's expense and to the satisfaction of the Regional District.
2. It should be demonstrated that locating development entirely outside of the development permit area has been considered, and a description of why that is not being proposed should be provided. It should be demonstrated that variances to minimize development in the development permit area have been obtained or considered.
3. Where the assessment report recommends revegetation and/or enhancement works, the Regional District may require the applicant to submit a landscaping plan and a security deposit equal to the total estimated costs of all materials and labour as determined by a Landscape Architect or other qualified professional to the satisfaction of the Regional District.
4. Development should:
 - a) be designed to ensure that development can withstand the hazard;
 - b) take a form that minimizes the development with any hazardous areas and minimizes impact on the natural features including vegetation, that help to mitigate flood and/or erosion risk; and
 - c) be conducted at a time of year, and use construction methods, that minimize the impact on the development permit area.

5.1.6 Hazard Lands Development Permit Area

5. Prior to construction commencing, the installation of temporary fencing or flagged stakes marking any areas to be avoided due to either hazardous conditions or to avoid disturbance to a sensitive vegetation that plays a role in mitigating the hazard, is required.

Guidelines related to flood hazard

6. Development or subdivision of land should be designed to:
 - a) replicate the function of a naturally vegetated watershed;
 - b) maintain the hydraulic regime of surface and groundwater and pre-development flow rates; and
 - c) not interfere with groundwater recharge.
7. Wetlands and other natural water features should be maintained in their natural state to enhance natural flood storage and protect environmentally sensitive ecosystems. Restoration of previously impacted natural freshwater systems should be considered in this development permit area to improve flood hazard mitigation.
8. Site development shall preserve natural vegetation where it contributes to flood protection and mitigation.
9. Where the placement of fill is proposed within a floodplain, the fill must not restrict the passage of flood waters, redirect flood flows, decrease natural flood storage, or result in higher flood flows or flood potential elsewhere in the floodplain. The Regional District may require a report by a Professional Engineer that ensures the placement of the proposed fill would not restrict the passage of flood waters, redirect flood flows, decrease natural flood storage, or result in higher flood flows or flood potential elsewhere in the floodplain.

Guidelines related to steep slopes

10. No unnecessary disturbance of the steep slope shall be permitted. Site development shall preserve natural vegetation on steep slopes and retain the natural terrain, topography of the site, and minimize cutting into the slopes.
11. Development at the top and toe of a steep slope should be designed to prevent negative impacts to slope stability and protect development from the hazard. The assessment report should include recommendations for development such as drainage management, landscaping, and proximity of buildings and structures to the slope.

5.1.7 Farmland Protection Development Permit Area

Information Note: the designation of this development permit area and description of the special conditions or objectives that justify the designation are located in the applicable official community plans.

APPLICABILITY

A development permit is required for the following activities wherever they occur within the Development Permit Area, unless specifically exempted:

1. Subdivision of land as defined in the *Land Title Act* or bare land strata under the *Strata Property Act*.
2. For Electoral Areas A, E and G only where the lot is greater than 5000 m²:
 - a) alteration of land, disturbance of soils, including grubbing scraping and removal of top soils;
 - b) construction or erection of buildings and structures; and
 - c) creation of non-structural impervious or semi-pervious surfaces.

EXEMPTIONS

The following activities are exempt from any requirement for a development permit:

1. Development on lands within the ALR.
2. Development in accordance with an existing covenant for maintenance of a landscaped buffer related to adjacency of the ALR.
3. Lands zoned industrial, and proposed to be or being used for industrial purposes.
4. Subdivision where each proposed lot within the DPA have a minimum lot depth of 50 metres measured perpendicular from the ALR boundary.
5. The activity is part of a farm operation as defined by the *Farm Practices Protection (Right to Farm) Act*; is a permitted farm use as defined in Section 2(2) of the *Agricultural Land Reserve Use, Subdivision, and Procedures Regulations*; and the lands are assessed as 'farm' under the *BC Assessment Act*. The farm operation of land clearing is only exempt from the requirement of a development permit if conducted in accordance with a current Environmental Farm Plan (less than five years old); otherwise, land clearing as part of a farm operation is not exempt. Note that other provincial legislation such as the *Waste Management Act* and the *Water Sustainability Act* may apply to farm operation activities.
6. Construction of a building or structure located further than 15 metres from the boundary of the ALR.
7. Land alteration, disturbance of soils, including grubbing, scraping and removal of top soils greater than 15 metres from the boundary of the ALR.
8. Maintenance of existing buildings and structures.
9. Reconstruction of, redevelopment of, additions (including second storey), or alterations to an existing dwelling unit or other building or structure within the development permit area

provided the changes do not result in the buildings or structures being located further within the DPA than the existing buildings or structure.

10. Construction of one access driveway provided it is no more than 9.0 metres in width.
11. The construction of a fence provided the area being disturbed to allow for construction and maintenance is 3.0 metres or less in width, and no trees with a diameter at breast height of 10 centimetres or more are being removed.
12. Emergency procedures to prevent, control, or reduce erosion, or other immediate threats to life and property including:
 - a) emergency flood or protection works;
 - b) clearing of an obstruction from bridge, culvert, or drainage flow, repairs to bridges and safety fences;
 - c) any emergency works to be undertaken in accordance with the Provincial *Water Sustainability Act* and *Wildlife Act*, and the Federal *Fisheries Act*.
 - d) notwithstanding the above, emergency actions for flood protection and clearing of obstructions by anyone other than the Regional District or Ministry must be reported to the Regional District and applicable Ministry immediately to secure exemption under this provision. Note that once the emergency has passed, a development permit may be required for remediation or permanent protection works.
13. Removal of trees deemed hazardous by a certified Arborist or Registered Professional Forester that pose an immediate threat to buildings or life safety. Removal of hazardous trees that also contain an eagle or heron nest is exempt only if a permit under the *Wildlife Act* has been obtained.
14. The small-scale, manual removal of non-native invasive plants or noxious weeds or planting of non-invasive, native vegetation on a small scale conducted in accordance with best practices such as the Invasive Plant Council of BC's 'Grow Me Instead' publication.
15. All forest management activities on lands subject to the *Forest Act* or *Private Managed Forest Land Act* and classified as 'Forest Lands' on the property assessment.
16. Works conducted by the Regional District or its agents where appropriate measures have been undertaken to satisfy the applicable development permit area guidelines as determined by the Regional District.
17. The construction of a small accessory building or structure if all the following apply:
 - a) the building or structure is located within an existing landscaped area;
 - b) no native trees with a diameter at breast height of 20 centimetres or greater are removed;
 - c) there is no permanent foundation;
 - d) the building or structure meets setbacks in the zoning bylaw; and
 - e) the total area of the small accessory building or structure is less than 10 square metres.

GUIDELINES

1. A 15 metre wide vegetated buffer should be retained or established and maintained on land adjacent to an ALR boundary. The buffer shall generally be designed and landscaped using materials set out in *Guide to Edge Planning: Appendix B*, published by the BC Ministry of Agriculture, or any subsequent editions.
2. Within the vegetated buffer area mature trees and existing native vegetation shall be preserved and where possible integrated with the new landscaping. The planting of trees is strongly encouraged.
3. Plant layout, spacing and support shall generally be in accordance with *Guide to Edge Planning: Appendix B*, published by the BC Ministry of Agriculture, or any subsequent editions. The planting material should include non-invasive, low maintenance, native vegetation that can thrive with little or no fertilizer.
4. Where the introduction of vegetation is required within the development permit area, the Regional District may require the applicant to submit a landscaping and security deposit equal to the total estimated costs of all materials and labour as determined by a landscape architect or other qualified person to the satisfaction of the Regional District.
5. New buildings and structures, except for fencing, should not be situated within the 15 metre vegetated buffer area.
6. Despite the above guidelines, a vegetated buffer of less than 15 metres may be considered in cases where 15 metres is not possible due to existing lot size or other natural or human-made constraint, and buildings or structures may be located within the 15 metres area where it is shown there are no other practical options. Where the buffer area is proposed to be less than 15 metres, as much existing buffering vegetation as possible should be retained or enhancement of vegetation and/or construction of fencing should be undertaken.
7. The vegetated buffer should be installed prior to commencing construction or land alteration, or prior to final subdivision approval.
8. A Section 219 covenant as per the *Land Title Act* may be required to restrict the removal of vegetation and the construction of any buildings or structures other than fencing within the buffer area, and notify any future property owner that the lot is adjacent to the ALR where normal farm practices may produce noise, odour, dust or other impacts.
9. Subdivision design must minimize the impacts that may occur between farm and non-farm uses on adjacent ALR lands including but not limited to the following:
 - a) Site design to allow the clustering of lots, buildings or structures away from ALR lands.
 - b) Avoid road endings or stubs which point directly into the ALR, and half roads along the ALR boundary, except where required for access by farm vehicles.
 - c) Where a parkland dedication is required, the dedication should be located next to the ALR boundary and include the required vegetated buffer.
10. Fencing should be constructed generally in accordance with *Guide to Edge Planning: Appendix C – Fencing Specifications*, published by the BC Ministry of Agriculture, or any subsequent editions.

5.1.8 Yellow Point Aquifer Development Permit Area

Information Note: the designation of this development permit area and description of the special conditions or objectives that justify the designation are located in the Electoral Area A Official Community Plan.

APPLICABILITY

A development permit is required for the following activities unless specifically exempt:

1. Subdivision of land as defined in the Land Title Act or the Strata Property Act; and,
2. Construction, alteration, or erection of a dwelling unit(s).

EXEMPTIONS

The following activities are exempt from requiring a development permit:

1. Subdivision of land which results in three or fewer lots and the parcel proposed to be subdivided has not been subdivided within the past five years.
2. Land alteration.
3. Construction of a dwelling unit or subdivision of land on lands serviced by a community water system.
4. Construction and/or alteration of accessory buildings, agricultural buildings, structures and fencing.
5. Construction or renovation to commercial, institutional, recreational, and industrial buildings.
6. All additions or alterations to an existing dwelling unit.
7. The replacement or reconstruction of an existing dwelling unit with another dwelling unit within the same basic footprint.
8. Construction of a secondary suite.
9. Construction of a dwelling unit where the applicant demonstrates that there is:
 - a) A well that existed prior to July 26, 2011 which produces a minimum of 3.5 m³ per day year round that will be connected to the proposed dwelling unit;
 - b) an existing (prior to July 26, 2011) water license with capacity to satisfy at least 30% of total household water use for a 90 day period; or
 - c) a valid approved source of water which is not groundwater that is currently in use and has adequate capacity to satisfy at least 30% of total household water use for a 90 day period.
10. Construction of a dwelling unit where the dwelling unit:
 - a) Is not to be connected to a groundwater source; and,
 - b) Is entirely serviced with water through stored and treated rainwater which meets or exceeds Canadian Drinking Water Standards.

Note: for exemption 10 above, prior to the issuance of a building permit, a report from an Engineer or other qualified professional may be required to satisfy the Regional District that the proposed rainwater

system has adequate capacity to meet the year round water demands of the dwelling unit being proposed and that the water will be stored and treated to Canadian drinking water standards.

GUIDELINES

A. For subdivision, the following guidelines apply:

1. Where property is proposed to be subdivided and more than three parcels, including the remainder (if applicable) are proposed, the Regional District shall require the applicant to supply a report prepared by a professional Hydrogeologist or engineer registered in the province of British Columbia and experienced in hydrogeological investigations which includes the following:
 - a) An assessment of the characteristics and behavior of the aquifer at its most stressed time of the year which includes two cross sections which define the groundwater body and determine where the water comes from. The assessment must also examine the location of proposed wells and their interaction with the Yellow Point Aquifer;
 - b) The results and professional interpretation of a minimum 72 hour pumping test to occur in at least one location within the lands being subdivided or a greater number as recommended by a professional hydrogeologist or engineer based on the scale of development and aquifer characteristics;
 - c) An assessment of seasonal water table fluctuations and the ability of the Yellow Point aquifer to provide a sustainable water supply which satisfies the additional groundwater demand without impacting adjacent rural properties or restricting or limiting the availability of water supply for agricultural irrigation;
 - d) An assessment of the potential for salt water intrusion as a result of the proposed water extraction which is required to service the proposed development; and,
 - e) Identification of key recharge points located on the subject property and recommended measures to protect them.
 - f) Recommendations to address the impacts on groundwater quality and quantity identified through the assessments outlined in sections 1.i – v.

The Regional District shall require the applicant to implement the report's recommendations in the proposed development and the recommendations shall become conditions of the development permit.

2. The Regional District may require, at the applicant's expense, and to the satisfaction of the Regional District, a Section 219 covenant registering the Hydrogeologist's and/or engineer's report on the title of the subject property.
3. The Regional District may require the applicant to install a groundwater monitoring device in at least one well within the proposed subdivision. The Regional District may require an agreement be registered on title to allow the Regional District to access the property to collect data from the device
4. Where rainwater management is recommended by the report identified in Guideline 1 above, rainwater must be retained on site and managed using methods such as vegetated swales, rain gardens, or other methods which allow rainwater to return to the ground.

B. For the construction of a dwelling unit the following guidelines apply:

Siting of Buildings and Structures

1. Dwelling units must be sited to allow for the optimal placement of a gravity fed rainwater collection tank which collects rainwater from the roof leaders of the dwelling unit which captures the majority of the rainwater flows.
2. Water storage tanks should be sited in the least obtrusive way possible from the neighboring properties.
3. A site plan should be provided illustrating the location of the proposed water storage tank(s) in relation to the proposed dwelling unit and adjacent property lines. The site plan should illustrate the rainwater harvesting system components and may be prepared by the applicant provided it is drawn to scale and is legible.

Form and exterior design

4. Dwelling units should be designed to optimize opportunities for rainwater capture for the intended use and corresponding cistern volume.
5. Roof surface materials should be selected to accommodate the type of rainwater harvesting system being proposed.

Specific features in the development

6. Impervious surfaces should be minimized. The use of impervious paved driveways is discouraged.

Machinery, equipment, and systems external to buildings and other structures

7. The Regional District shall require that all new dwelling units include a rainwater harvesting system which is designed to satisfy a minimum of 30% of the total household water use (indoor and outdoor) for a minimum of 90 consecutive precipitation free days.
8. Rainwater harvesting systems should target a minimum rainwater storage tank volume of 18,181 litres (4,000 Imperial Gallons). Larger tank sizes are also supported. This figure was derived based on the following information and calculation:

- Average total household water use the RDN is 704 litres per day
- 30% of the total household water use is for outdoor non-potable use
- Storage must satisfy 100% of outdoor watering needs for a 90 day period

Minimum tank volume is calculated as follows:

Average household use per day \times 0.3 \times 90 days = minimum water storage tank volume

$$704 \text{ litres} \times \frac{30}{100} \times 90 \text{ days} = 19,008 \text{ litres}$$

9. Notwithstanding Guideline 8 above, a water storage tank with a lesser volume may be supported where an assessment of total household water use (indoor and outdoor) prepared by a registered plumber, accredited rainwater harvesting professional, or Engineer is provided, and the applicant is proposing to satisfy a minimum of 30% of total household use for a minimum of 90 consecutive precipitation free days with a rainwater harvesting system.

10. Rainwater harvesting systems may, at the applicant’s discretion, be designed for non-potable outdoor use, non-potable indoor use, or potable drinking water use. The design of such systems must reflect their intended use.

11. The rainwater harvesting system design must, at minimum, consider and include the following components:

- a) Roofing materials that are appropriate for the type of rainwater harvesting system being proposed.
- b) Gutters, downspouts, and transport piping to move the rainwater collected on the roof towards the water storage tank and beyond to its end use.
- c) Debris removal, filters, and first flush diverter sized and designed to accommodate the proposed rainwater harvesting system.
- d) Provisions for tank overflow.
- e) A water storage tank(s) rated for potable use while it is strongly recommended that all other components be rated for potable use.
- f) A pumping system to move the rainwater and distribution system.
- g) Rainwater filtration, purification, and disinfection (in the case of potable systems).

12. Rainwater harvesting systems should be designed to facilitate additional storage volume and future connection to the dwelling unit.

13. All external pipe, plumbing fixtures, and hose bibs where rainwater is used shall be clearly marked with “Non-Potable Water Do Not Drink” as shown in Diagram 2 at right.

14. Although not a requirement of these Development Permit Area Guidelines, where non-potable rainwater harvesting equipment is required, the Regional District shall encourage the applicant to install dedicated plumbing lines within proposed dwelling units to make use of stored rainwater for flushing toilets and other non-potable uses. The Regional District shall assist the applicant in obtaining the necessary building permit approvals.



DEFINITIONS

Total household water use means the sum total of all water use in a household during a typical hot dry summer day including gardens and lawns, baths and showers, kitchen (dishwasher, etc.), toilet flushing, laundry, car washing, drinking, property maintenance, and other outdoor uses.

5.1.9 South Wellington Industrial – Commercial Development Permit Area

Information Note: the designation of this development permit area and description of the special conditions or objectives that justify the designation are located in the Electoral Area A Official Community Plan.

APPLICATION

A development permit is required for the following activities unless specifically exempt:

1. Alteration of land, disturbance of soils, including grubbing, scraping and removal of top soils;
2. Construction, alteration, or erection of buildings and structures; and,
3. Creation of non-structural impervious or semi-pervious surfaces;

EXEMPTIONS

1. A development permit shall not be required for the construction, renovation, or addition to single or duplex dwelling units or accessory residential buildings.
2. A development permit shall not be required for the subdivision of land.
3. A development permit shall not be required for alterations or additions to a building which do not require a building permit. This exemption excludes new signage which shall require a development permit.

GUIDELINES

General Design

1. The Regional District shall require building elevations prepared by an architect or other qualified designer.
2. The use of non-combustible building materials is encouraged and where feasible locally produced natural building materials should be incorporated in to the design without compromising the building or structure's fire resistance.
3. There shall be no net increase in peak rainwater run-off from the land to adjoining lands.
4. Development of land should be designed to:
 - a) Replicate the function of a naturally vegetated watershed;
 - b) Maintain the hydraulic regime of surface and groundwater and pre-development flow rates;
 - c) Not interfere with groundwater recharge; and,
 - d) Not introduce or remove materials where it would cause erosion of or the filling in of natural watercourses and/or wetlands.
5. Public open space and pedestrian walkway linkages to adjacent neighbourhoods which complement existing parks and recreation opportunities and reduce automobile dependence shall be encouraged.
6. The use of energy efficient building materials, techniques, and practices that reduce the amount of energy consumption shall be encouraged.

7. The use of rainwater catchment and reuse as well as other water conservation devices and strategies shall be encouraged.
8. Buildings and structures, located on parcels adjacent to the Tran Canada Highway, South Wellington Road, or Schoolhouse Road, shall generally be sited and shaped in a visually unobtrusive manner.

Parking and Loading

9. Parking and loading areas shall generally be located to the rear of buildings, should be screened from view from the Trans Canada Highway and adjacent residential uses and be located outside of the minimum required zoning setback, unless a variance is being considered. Screening should consist of landscaping, fencing, or a combination of landscaping and fencing. Parking areas should include landscaped areas, defined by concrete curbs, to provide visual breaks between clusters of approximately ten stalls.
10. Vehicular and truck movement patterns must be illustrated on the site plan submitted by the applicant to ensure adequate circulation. A Professional Engineer may be required to ensure that adequate lane widths and turning radiuses are provided for all forms of vehicles intended to use the property.
11. Provision should be made for public transit, emergency vehicles, delivery and service vehicles.
12. Safe and effectively designed and located internal roadways, entrance points, parking areas, pedestrian paths, and open spaces shall be provided.

Landscaping and Screening

13. The applicant may be required to submit a landscaping plan prepared by a landscape architect or equivalent designer which meets the current edition of the British Columbia Landscape Standard and satisfies the following objectives:
 - a) To use a variety of drought tolerant deciduous and evergreen native plant species that are best suited to the site specific growing conditions;
 - b) To minimize water consumption through means such as micro-irrigation and xeriscaping;
 - c) To provide visual separation from the Tran Canada Highway and compatibility with surrounding single residential uses;
 - d) To improve the aesthetic appeal of the development;
 - e) To assist in the safe movement of pedestrians throughout the site;
 - f) To reduce the amount of impervious surfaces on the site;
 - g) To complement the development and surrounding uses;
 - h) To establish or enhance habitat values on the development site where appropriate; and/or,
 - i) To shade the development from the summer sun.
14. The landscaping plan must be drawn to scale and show the type, size, and location of proposed landscaping and shall be submitted with the development permit application.

15. At minimum, and in addition to the requirements specified in Regional District of Nanaimo Land Use and Subdivision Bylaw No. 500, 1987 as amended or replaced from time to time, the landscape design should provide:
 - a) A continuous landscaped screen area of at least 2.0 metres in width along the inside of all property lines, excluding access points and adjacent to all roads and highways;
 - b) Where landscaping is for the purpose of visual separation, a minimum height of 5.0 metres once mature; and,
 - c) A landscape buffer of at least 5.0 metres in width to create spatial separation between non-residential and residential zoned properties and should contribute towards the objectives identified in Policy 20 above.
16. Notwithstanding Policy 20 above, the landscaped buffer width and enhancement works adjacent to any watercourse shall be determined by a Qualified Environmental professional and shall work towards Policy 20(h) above– to establish or enhance habitat values on the development site.
17. Development should be sited in a manner that minimizes the disturbance of existing native vegetation.
18. Vegetation species used in replanting, restoration, and enhancement shall be selected to suit the local soils; light conditions, and groundwater regime of the site and should be native to the area, and where applicable, selected for erosion control and/or fish and wildlife habitat values.
19. All landscaping shall require the following minimum depth of topsoil or amended organic soils on all landscaped areas of a property:
 - a) Shrubs – 45 cm;
 - b) Groundcover and grass – 30 cm; and,
 - c) Trees – 30 cm around and below the root ball.
20. Where irrigation is required to maintain proposed landscaping, it should be designed by an Irrigation Industry Association of British Columbia certified irrigation designer and be installed by an irrigation industry association of British Columbia irrigation contractor or other equivalent to the satisfaction of the Regional District.
21. The Regional District shall require the applicant to submit a landscaping and security deposit equal to the total estimated costs of all materials and labour as determined by a landscape architect or other similarly qualified person to the satisfaction of the Regional District to be released upon final inspection by a landscape architect or other similarly qualified person to the satisfaction of the Regional District.
22. Garbage and recycling containers shall be screened with landscaping and solid gated fencing to a minimum height of 2.0 metres. Similarly, utilities, service kiosks, meters, elevator housing, exhaust elements, satellite dishes, etc. shall be screened with fencing, landscaping, or a combination of the two.
23. Chain link fencing shall be used only when screened by landscaping. Decorative fences are encouraged which complement the materials used for the principle building.

Site Illumination and Signage:

24. Lighting should be designated for security and safety. However, there should not be glare on neighbouring properties, adjacent roads or light directed towards the sky.
25. All new, replacement, and upgraded exterior lighting in existing and proposed developments shall be Full Cut-off Flat Lens (FCO/FL) luminaries to light roads, parking, loading, and pedestrian areas. Exterior building lighting will also be required to have FCO lighting fixtures.
26. The size, location, and design of freestanding signage shall be architecturally integrated with the overall design of the buildings and landscaping. The design of fascia signs containing individual business signage shall be integrated into the design of the building.
27. Signage should be visually unobtrusive; particular emphasis should be given to signage which is aesthetically pleasing and requires a minimal amount of lighting or boldness to be effective. No video, reader board, neon, or LED signs will be supported.
28. Where there is a conflict between these DPA guidelines and the [RDN Sign Bylaw No. 993, 1995](#), these guidelines shall prevail. However, a variance to the sign bylaw may be required.

Pedestrian and Cyclist Considerations:

29. Pedestrian sidewalks or defined pathways connecting building entrances to and through parking areas and sidewalks or road right of ways of the adjacent streets should be provided.
30. All internal pedestrian walkways shall be distinguished from driving surfaces through the use of a clearly delineated pathway or durable low maintenance surface material such as pavers, bricks, or concrete to enhance pedestrian safety and comfort as well as the attractiveness of the walkways.
31. Bicycle parking facilities should be considered at grade near primary building entrances.

5.1.10 Cedar Main Street Development Permit Area

Information Note: the designation of this development permit area and description of the special conditions or objectives that justify the designation are located in the Cedar Main Street Village Plan.

APPLICATION

A development permit is required for the following development activities unless specifically exempt:

1. Alteration of land or disturbance of soils such as grubbing, scraping, and removal of top soils;
2. Construction, alteration, or erection of buildings and structures; and,
3. Creation of non-structural impervious or semi-pervious surfaces.
4. Subdivision of land(s).

EXEMPTIONS

A Development Permit shall not be required for the following:

1. Construction, renovation, or addition to a single or duplex dwelling unit or accessory residential building on a lot.
2. The replacement or repair of an existing sign provided that the sign is not enlarged or moved and is replaced with the same type of sign (i.e. fascia, freestanding, canopy, etc.).
3. Subdivision of land, except in the case of subdivision for intensive residential¹.
4. Renovations or alterations within a building.
5. Alterations or additions to a building which do not require a building permit, except where new signage requires a development permit.
6. Development activities that are not visible from Cedar Road or other public spaces.
7. Invasive species removal on lands located outside of the 30 metre Riparian Assessment Area or the Streamside Protection and Enhancement Area as established by a Qualified Environmental Professional.
8. Construction of unattended public utilities.
9. Construction of an attended public utility and related accessory buildings and structures (excluding government office) such as a water treatment facility, shall be exempt from DPA guidelines in the following categories: General Guidelines, Building Massing, Site Planning and Pedestrian Design, Façade Design and Architectural Detailing.

¹ For the purpose of this DPA, intensive residential shall mean any residential development with an average minimum parcel size less than 2000 m² or density greater than 5 dwelling units per ha whether fee simple or strata.

VARIANCES TO BYLAW NO. 500

The requirements of this Plan may not be consistent with the Regional District of Nanaimo Land Use and Subdivision Bylaw No. 500, 1987. Where there is inconsistency between Bylaw No. 500 and these DPA Guidelines, a variance to Bylaw No. 500 may be required to meet the intent of this Plan.

PERMIT SECURITY

1. The Regional District may require applicants for any development permits within the Cedar Main Street Development Permit Area to provide security in the form of cash or an unconditional, irrevocable and automatically renewing letter of credit in cases where:
 - The Regional District considers that damage to the natural environment (including ground and surface water) could result as a consequence of a contravention of a condition in a development permit issued;
 - The permit holder is required to retain, restore or replace vegetation;
 - The permit holder is required to provide landscaping; and/or,
 - The permit holder is required to provide onsite rainwater management.

The amount of these securities shall be determined by a qualified person and shall be sufficient to cover the cost of materials and labour.

GUIDELINES

The Cedar Main Street Development Permit Area Guidelines are organized into the following ten categories.

- | | |
|--|----------------------------|
| 1. General Guidelines | 6. Architectural Detailing |
| 2. Building Massing | 7. Landscape Design |
| 3. Site Planning and Pedestrian Design | 8. Signage |
| 4. Green Building | 9. Lighting |
| 5. Façade Design | 10. Parking and Loading |

Development applications must generally satisfy all applicable Development Permit Area Guidelines in order for staff to recommend approval of a Development Permit application.

General Guidelines

1. Development is encouraged to incorporate design elements and reflect the general intent of the Design Ideas included in Sections 3 and 4 of the Cedar Main Street Village Plan.
2. Where new or alterations to buildings and structures are proposed, the Regional District may require building elevations prepared by an architect or other qualified designer.
3. In the case of subdivision for intensive residential development, each dwelling unit shall be designed in a way which is consistent with the direction provided in this Development Permit Area. Building elevations showing how the proposed buildings comply may be required and may be secured at the time of subdivision through the use of a Section 219 covenant.

BUILDING MASSING

4. A variety of architectural styles shall be used that create visual interest, complement adjacent buildings, and reflect local culture and history. Applicants are encouraged to refer to the Visual Preference Exercise results contained in the Final Charrette Report dated June 2012 for inspiration.
5. Larger buildings (>12 metres in width) shall be designed in such a way as to avoid large flat building expanses which are visible from Cedar Road. Large expanses shall include trim, design features (such as windows, gables, projections, and porches), varied façade materials, and architectural design.

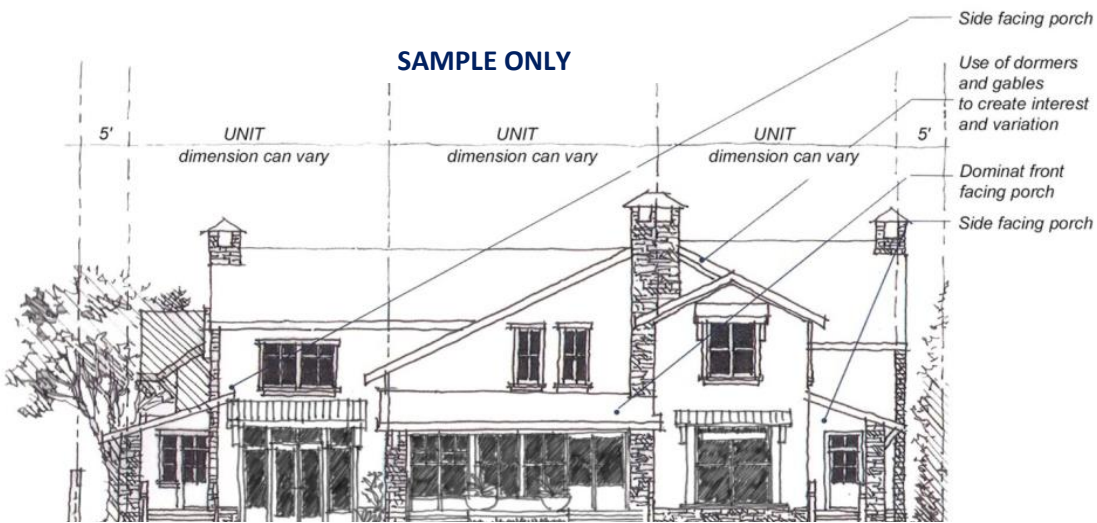

Sample of how a larger building could be designed to avoid large flat building expanses.

6. Larger buildings should be consistent with the height and emerging character of other buildings on the street.
7. Smaller buildings (≤ 12 metres in width) should include one or more of the following design features:

- a) Design which maintains a residential scale and simplicity in façade and roof design;
- b) Generous first floor heights;
- c) Front porches or patios;
- d) A vertical orientation not in a rancher style;



SAMPLE: Building with vertical orientation



5.1.10 Cedar Main Street Development Permit Area

- e) Gable ends of the roof facing Cedar Road. (exceptions can be made for flat roofed buildings and buildings utilizing passive solar and requiring certain roof orientations; and,
 - f) Architectural design which compliments adjacent buildings through contrasting roof orientations and shapes. Roof design that provides usable space through dormers and gables is strongly encouraged.
8. Multi-tenant/Multi-use buildings should include independent entrances and visual separation between uses. Visual separation could include both colour, façade, and/or other design elements.
9. New buildings should appear to be two storeys as viewed from Cedar Road.
10. A third floor can be included where:
- a) It is fully contained within the roof and the building.
 - b) It maintains a two storey appearance from Cedar Road.
 - c) The building meets the fire protection and rescue requirements of the North Cedar Fire Department.²
11. Buildings should emphasize a 'small town' or 'rural' scale and should utilize a variety of heights, varied building faces, and artistic design features to add interest to the streetscape.



Example of third floor space built into the roofscape.

SAMPLE ONLY



Example of how topography could be used to support of third storey within the roof on the downslope side of a parcel.

² Applicants may be required to submit correspondence from the North Cedar Fire Department regarding both fire protection and rescue.

SITE PLANNING AND PEDESTRIAN DESIGN

- 12. Travel ways which straddle lot lines to accommodate shared access and/or parking facilities are preferred. Travel ways should be avoided between every building.
- 13. Mixed use and commercial buildings shall be located in close proximity to the sidewalks and the pedestrian space.

SAMPLE ONLY



- Third floor space where bonused shall be built into the roofscape through hand framed rafters.
- Travel ways which straddle the lot line are preferred.
- Parking shall not be placed in front of buildings.
- Storefront entrances should be covered from the elements.
- Provide bicycle racks
- Where on-street parking is possible it shall be used in the overall parking counts.

Illustration of desirable design elements such as mixed on and off street parking and shared travel ways between developments.

- 14. Design, siting, and construction of sidewalks shall be determined through discussions with the owner/developer and MOTI where applicable.
- 15. Where mixed use or commercial buildings are proposed, avoid large spaces between buildings.
- 16. Maximize opportunities for the creation of accessible public space such as patios, plazas, and courtyards.
- 17. The use of drive-through shall not be part of building or site design.
- 18. For commercial and mixed-use developments



Example of a covered walkway

SAMPLE ONLY



Illustration of commercial building storefront located in close proximity to the sidewalk.

5.1.10 Cedar Main Street Development Permit Area

continuous weather protection for pedestrians should be provided on the exterior of the building. This can be accomplished in a number of ways including:

- a) Maintaining covered porch areas adjacent to building entrances;
- b) Providing canopies above storefront doors constructed of wood or other quality, durable materials which are colour-fast and resistant to deterioration caused by dampness; and,
- c) Extending roof elements at least 1.8 metres past the building envelope provided the roof above is no more than 5.5 metres in average above the storefront threshold.

19. Safe, convenient pedestrian routes for all units should be provided from the unit to an abutting street. All pedestrian access points and routes should be designed for universal access to accommodate persons with disabilities.

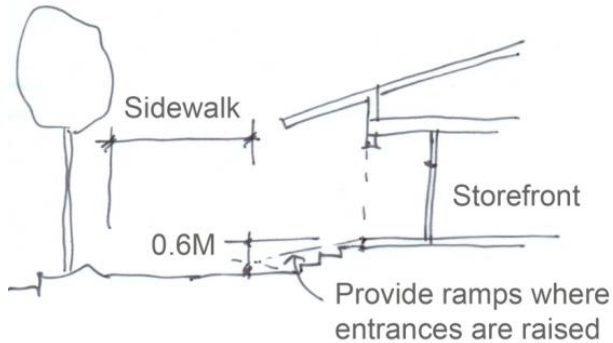

20. Where the possibility for view exists, the protection and creation of view corridors towards York Lake or the Nanaimo River should be incorporated in a site's design.

21. Where a building is adjacent to Cedar Road, its principal elevation should be oriented towards Cedar Road and designed in such a manner as to promote a lively energetic, pedestrian-oriented, streetscape. Residential developments proposed to be screened from Cedar Road are exempt from this guideline.

22. Buildings located on corner lots should be oriented towards both streets and building design should add significant prominence to the corner.

23. Outdoor seating areas should be provided.

SAMPLE ONLY



Example of an outdoor seating area on a corner

GREEN BUILDING

24. The use of rainwater harvesting for landscape irrigation and other indoor and outdoor non-potable uses should be used. The use of potable rainwater harvesting systems for potable is encouraged³ where supported by a report from a Professional Engineer or other qualified person that the system⁴ produces water that meets or exceeds Canadian Drinking Water Standards in a quantity sufficient for the proposed use.
25. Sites should be evaluated for passive solar gain opportunities. On sites with substantial solar exposure, buildings should be sited, designed, and landscaped to take advantage of passive solar gain in winter and reduce sun exposure in summer.
26. Electric vehicle charging stations are encouraged.
27. All new commercial, mixed use, and multi-unit residential buildings within the Development Permit Area should strive to achieve a third party certification such as built green gold or Leadership in Energy and Environmental Design (LEED). The Regional District may provide assistance in the Planning and Design Process and may offer grants and incentives in accordance with current offers and rebate programs.
28. The use of solar panels, geothermal heating and other efficient or renewable energy use alternatives are encouraged in building and site design.

FAÇADE DESIGN

29. Visually appealing quality siding materials shall be used.
30. Building design shall avoid large expanses of any one type or style of cladding.
31. The use of vinyl siding should be minimized.
32. To create visual interest the following design strategies shall be used:
 - a) Create different textures by using both horizontal and vertical façade elements;
 - b) Break up large building expanses;
 - c) Separate uses with trim and exterior design features; and,
 - d) Use a variety of complementary types of siding material, trim, colour, etc.
33. A variety of complementary colours shall be used. The use of at least three different colours on the building exterior is encouraged.
34. Materials must be high quality, practical, durable, and hard wearing and must be appropriate for a west coast environment. Materials that integrate well within the natural environment should be included in the design.

³ May require approval from outside jurisdiction such as Vancouver Island Health Authority or North Cedar Improvement District.

⁴ System includes roofing material, collection, treatment, and all other components.

ARCHITECTURAL DETAILING

- 35. Buildings should utilize a variety of high quality complimentary architectural styles rather than a unified design theme.
- 36. Exposed structural elements such as exposed rafter tails, timber brackets, posts, and beams are encouraged.

SAMPLE ONLY



Example of different architectural types that are supported.

- 37. At gable ends, encourage the use of frieze boards, details, and other trim.

SAMPLE ONLY



Care should be taken in detailing the façade. Use trim in appropriate dimensions and locations.

SAMPLE ONLY



Illustration showing the use of frieze boards and other trim

38. Larger buildings shall utilize accent design features/ strategies to break up large expanses of siding.
39. Rooftop mechanical units shall be screened from view with design elements that are incorporated within the architectural massing. Consideration should be given to impacts on adjacent properties.

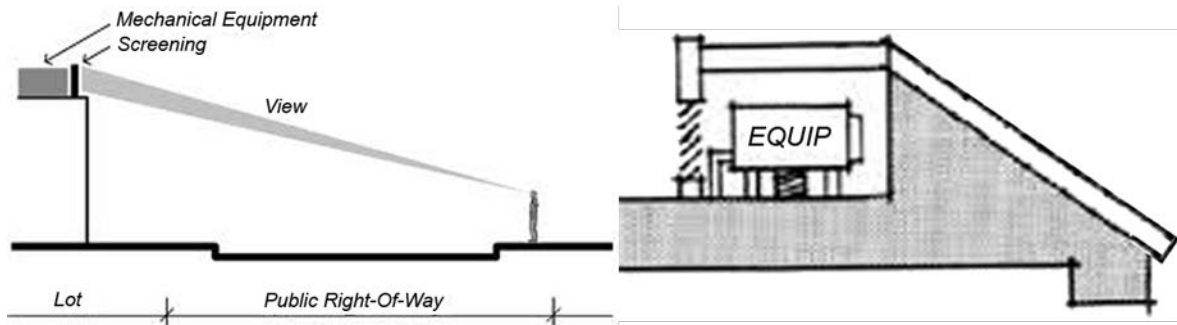

Examples of rooftop screening

LANDSCAPE DESIGN

40. Where landscaping is required as part of the development permit, the applicant shall submit a landscaping plan prepared by a landscape architect or equivalent designer which meets the British Columbia Landscape Standard and satisfies the following objectives:
 - a) To use a variety of drought tolerant deciduous and evergreen native plant species that are best suited to the site specific growing conditions;
 - b) To protect, enhance, or retain existing mature healthy vegetation;
 - c) To minimize water consumption through means such as micro-irrigation and xeriscaping;
 - d) To promote compatibility with surrounding uses;
 - e) To improve the aesthetic appeal of the development and adjacent streetscape;
 - f) To assist in the safe movement of pedestrians throughout the site;
 - g) To reduce the amount of impervious surfaces on the site;
 - h) To shade the proposed development from the summer sun;
 - i) To complement the development and surrounding uses; and/or,
 - j) To establish or enhance habitat values on the development site where appropriate.
41. Notwithstanding Guideline 40 above, edible landscapes (food producing plants, shrubs, and trees) are encouraged and may be considered part of the landscape design where suitable arrangements have been made for ongoing care and maintenance as well as produce harvesting to the satisfaction of the Regional District. Community gleaning is strongly encouraged.
42. The landscaping plan must be drawn to scale and show the type, size, and location of proposed landscaping and shall be submitted with the Development Permit application.

5.1.10 Cedar Main Street Development Permit Area

43. To provide separation between residential and non-residential uses (excluding mixed use buildings and developments and shared parking and laneways), a landscaped screen of at least 2.0 metres in width along the shared property lines, excluding access points, between all commercial and residential zoned properties should be provided.
44. Landscaping should be provided adjacent to all roadways to improve aesthetic appeal, minimize impervious surfaces, and provide a visual screen for all outdoor storage, refuse, parking, loading, and unloading facilities and must also work towards the objectives identified in Guideline 6.8.8(1) above.
45. Landscaping of boulevards should be provided, including the provision of street trees in accordance with the following:
 - a) All landscaping and works within the public road right-of-way require MOTI approval with a maintenance agreement arranged between the property owner/developer, MOTI, and the Regional District.
 - b) Where the opportunity exists, street trees should generally be provided as follows:
 - i. One high branched tree, of at least 5 centimetre caliper at breast height at time of planting, for every 6.0 metres of street property line with a maximum distance between trees of 12.0 metres, where the type and spacing of trees is to form a sidewalk canopy. Existing native vegetation may be considered provided it satisfies the general intent of this guideline;
 - ii. Tree species should be compatible with the local growing conditions and character of the area; and,
 - iii. A minimum of 3 cubic metres of appropriate soil and growing space is provided for each tree.
46. Garbage and recycling containers shall be screened with landscaping and/or gated fencing to a minimum height of 2.0 metres. Chain link fence may only be used in accordance with Guideline 52 below. Similarly, utilities, service kiosks, metres, elevator housing, exhaust elements, satellite dishes, etc. shall be screened with fencing, landscaping, or a combination of the two.
47. Buildings and structures should be sited in a manner that minimizes the disturbance of existing native vegetation.
48. A principle of 'no net loss' of significant native vegetation in any development should be considered. Where it is necessary to remove significant vegetation in order to develop a property, replacement plantings should be provided of a sufficient number, size, type, and maturity to offset its removal.
49. Plant species used in replanting, restoration, and enhancement shall be selected to suit the local soils; light conditions, and groundwater regime of the site and should be native to the area, and where applicable, selected for erosion control and/or fish and wildlife habitat values.
50. Unless otherwise noted above, all landscaping shall require the following minimum depth of topsoil or amended organic soils on all landscaped areas of a property:
 - a) Shrubs – 45 cm;
 - b) Groundcover and grass – 30 cm; and,
 - c) Trees – 30 cm around and below the root ball.

5.1.10 Cedar Main Street Development Permit Area

51. Where irrigation is required to maintain proposed landscaping, it should be designed by an Irrigation Industry Association of British Columbia certified irrigation designer and be installed by an Irrigation Industry Association of British Columbia irrigation contractor or other equivalent to the satisfaction of the Regional District.
52. The Regional District shall require the applicant to submit a landscaping and security deposit equal to the total estimated costs of all materials and labour, as determined by a landscape architect or other similarly qualified person to the satisfaction of the Regional District. The security shall be released following the completion of all approved landscaping and/or site improvements as specified in the Development Permit to the satisfaction of the Regional District. Notwithstanding the above, the Regional District shall withhold 25% of the security for one year to ensure proper maintenance.
53. Chain link fencing shall be used only when screened by landscaping. Decorative fences are encouraged which complement the materials used for the principle building.

SIGNAGE

54. Signs should be hand crafted and provide individuality to each establishment.
55. Materials chosen for signage should be durable enough to last for several years of continuous use, except for the special cases of temporary signage or banners.
56. The following types of signs are not considered acceptable:
 - a) reader board;
 - b) neon;
 - c) flashing;
 - d) animated;
 - e) rotating,
 - f) backlit; and,
 - g) signs which are illuminated in a way which projects light beyond the sign's surface or results in light being directed beyond the sign's surface or towards the sky.

SAMPLE ONLY



Example of a hand crafted sign

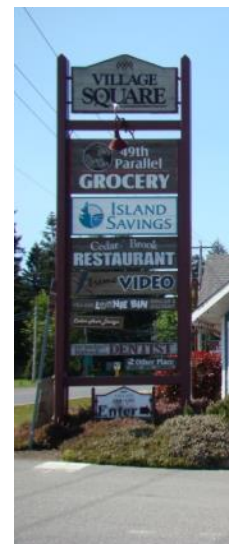

Example of a consolidated free standing sign

57. Signs should be designed to cater to the pedestrian (limit height, size, and placement) and be in scale with the building and be related to a use or a business within.

58. Free standing signage should be consolidated where possible with other businesses or uses as illustrated.

SAMPLE ONLY



Example of a fascia sign that is complementary to the design of the building and graphically communicates a message.

59. Creativity in how signs are designed (i.e. different shapes, colours, materials, and fonts) is supported.

60. The size, location, and design of freestanding signage shall be architecturally integrated with the overall design of the buildings and landscaping. The design of fascia signs containing individual business signage shall be complementary to the design of the building.

61. Signage should be visually unobtrusive and particular emphasis should be given to signage which is aesthetically pleasing and requires a minimal amount of lighting or boldness to be effective.

62. Signs should graphically communicate a message.

63. If there is a conflict between these Development Permit Area guidelines and the [RDN Sign Bylaw No. 993, 1995](#) as amended or replaced from time to time, these guidelines shall prevail. However, a variance to the sign bylaw may be required.

SAMPLE ONLY

LIGHTING

64. The use of solar lighting is encouraged.

65. Lighting should be designed for security and safety in accordance with Crime Prevention Through Environmental Design (CPTED) principles.

66. Site illumination must not result in glare directed towards neighbouring properties, adjacent roads, or light directed towards the sky.

67. Building façades may be discreetly illuminated through the use of strategically placed lighting which shines down from the buildings surface.



Full cut off light fixtures direct light below the horizontal plane reducing light pollution and protecting the night sky.

5.1.10 Cedar Main Street Development Permit Area

68. All new, replacement, and upgraded exterior lighting in existing and proposed developments shall be Full Cut-off Flat Lens (FCO/FL) luminaries to light roads, parking, loading, and pedestrian areas. Exterior building lighting will also be required to have FCO lighting fixtures.
69. Decorative street lights which are compatible with existing decorative street lighting and are in scale with their surroundings are encouraged.

PARKING AND LOADING

70. If on street parking is proposed, it must be designed by a Professional Engineer and approved by the Ministry of Transportation and Infrastructure.
71. On site parking and loading areas should generally be located to the rear or side of buildings, should be screened from view from the adjacent road, and be located outside of the minimum required building setback. The screening should consist of landscaping, fencing, or a combination of landscaping and fencing.
72. Vehicular and truck movement patterns must be illustrated on the site plan submitted by the applicant to ensure adequate circulation. A professional engineer may be required to ensure that adequate lane widths and turning radii are provided for all forms of vehicles intended to use the property.
73. Provision should be made for public transit, emergency vehicles, delivery and service vehicles.
74. Safe and effectively designed and located internal roadways, entrance points, parking areas, pedestrian paths and open spaces shall be provided.
75. Parking areas should be designed to be aesthetically pleasing and should include smaller groupings of parking spaces separated by landscaping and shade trees. Large expanses of open parking area should be avoided.
76. The use of permeable paving materials is encouraged in parking areas where it can be demonstrated that oil, water, and other potential contaminants will not enter the aquifer, river, lake, or wetland.
77. Bicycle parking facilities should be provided for each use in accordance with the following:
 - a) Office use: 0.5 - 1 space per 100 m² of gross floor area;
 - b) Institutional: 0.5 – 0.8 spaces per 100 m² of gross floor area;
 - c) Commercial: 1 space per 750 m² of gross floor area with a minimum of four spaces per establishment; or,
 - d) Multi-unit residential: 0.2 spaces per dwelling unit.

Where calculation results in a fractional number, the nearest whole number above the calculation shall be taken.

5.1.11 Cassidy Development Permit Area

Information Note: the designation of this development permit area and description of the special conditions or objectives that justify the designation are located in the Electoral Area A Official Community Plan.

APPLICATION

A development permit is required for the following activities unless specifically exempt:

1. Alteration of land and disturbance of soils;
2. Construction, alteration, or erection of buildings and structures;
3. Subdivision as defined in the [Land Title Act](#) or the [Strata Property Act](#); and,
4. Creation of non-structural impervious or semi-pervious surfaces;

EXEMPTIONS

1. A development permit shall not be required for the construction, renovation, or addition to one single or duplex dwelling unit or accessory residential building on one single lot.
2. The replacement or repair of an existing sign provided that the sign is not enlarged or moved and is replaced with the same type of sign (i.e. fascia, freestanding, canopy, etc.).
3. A development permit shall not be required for alterations or additions to a building which do not require a building permit. This exemption excludes new signage which shall require a development permit.

GUIDELINES

General Design

1. For commercial, multi residential, The Regional District shall require an applicant to submit building elevations prepared by an architect or other qualified designer.
2. Commercial and mixed use buildings should be designed to reflect the fact that they are located within a pedestrian environment and should be of human scale at street level and should aim to provide functional civic space.
3. The siting of buildings shall be integrated with other existing uses within the Cassidy Rural Village land use designation to promote safe pedestrian linkages and encourage consolidated vehicle access.
4. The use high quality building materials such as Hardiplank, stone, wood, brick, and other exterior natural building materials shall be encouraged.
5. Development should generally not be visible from the Trans Canada Highway with the exception of those properties north of Timberlands Road which are designated Commercial by this plan.
6. The architectural design of buildings and structures should be varied, aesthetically pleasing and visually pleasing.

5.1.10 Cassidy Development Permit Area

7. Buildings clad entirely in vinyl siding will be strongly discouraged. Where vinyl is used, it should be used sparingly and in combination with other materials.
8. The use of energy efficient building materials, techniques, technologies, and practices that produce local energy and/or reduce the amount of energy consumption shall be strongly encouraged which include, but are not limited to:
 - a) passive solar gain;
 - b) district heat and hot water;
 - c) solar voltaic cells;
 - d) solar hot water;
 - e) micro wind; and
 - f) geothermal.

Parking and Loading

9. Parking areas should be located to rear or side of buildings and should include landscaped boulevards and other aesthetically pleasing landscaping features.
10. In cases where parking is not practical to the rear or side of buildings, it may be supported in front of a building provided all parking areas are adequately screened by solid fencing, landscaping, or a combination of the two.
11. Loading areas should be located to the side or rear of buildings and should not be visible from the adjacent road.
12. Vehicular and truck movement patterns must be illustrated on the site plan submitted by the applicant to ensure adequate circulation. A professional engineer may be required to ensure that adequate lane widths and turning radiuses are provided for all forms of vehicles intended to use the property.
13. Provision should be made for public transit, emergency vehicles, delivery and service vehicles.
14. Safe, efficient, and effectively designed and located roadways, entrance points, parking areas, pedestrian paths and open spaces shall be provided.

Landscaping and Screening

15. The Regional District may require the applicant to submit a landscaping plan prepared by a landscape architect or qualified designer which meets the British Columbia Landscape Standard and satisfies the following objectives:
 - a) To use a variety of drought tolerant deciduous and evergreen native plant species that are best suited to the site specific growing conditions;
 - b) To minimize water consumption through means such as micro-irrigation and xeriscaping;
 - c) To improve the aesthetic appeal of the development;
 - d) To screen the development from the Trans Canada Highway and adjacent established neighbourhoods;

5.1.10 Cassidy Development Permit Area

- e) To maintain rural character;
 - f) To shade the proposed development from the summer sun;
 - g) To assist in the safe movement of pedestrians throughout the site;
 - h) To reduce the amount of impervious surfaces on the site;
 - i) To complement the development and surrounding uses; and,
 - j) To establish or enhance habitat values on the development site where appropriate.
16. The landscaping plan must be drawn to scale and show the type, size, and location of proposed landscaping and shall be submitted with the development permit application.
17. Where development is proposed adjacent to Timberlands Road, Hallberg Road, or the Trans Canada Highway, the landscape design should provide a landscaped buffer consisting of native vegetation either maintained, enhanced, or established of sufficient height, width, and density to provide spatial separation and screen the proposed development from view from Timberlands Road, Hallberg Road, and the Trans Canada Highway with the exception of strategically placed and consolidated signage and access and egress points.
18. All landscaping shall require the following minimum depth of topsoil or amended organic soils on all landscaped areas of a property:
- a) Shrubs – 45 cm;
 - b) Groundcover and grass – 30 cm; and,
 - c) Trees – 30 cm around and below the root ball.
19. Where irrigation is required to maintain proposed landscaping, it should be designed by an Irrigation Industry Association of British Columbia certified irrigation designer and be installed by an Irrigation Industry Association of British Columbia irrigation contractor or other equivalent to the satisfaction of the Regional District.
20. The Regional District shall require the applicant to submit a landscaping security deposit equal to the total estimated costs of all materials and labour as determined by a landscape architect or other similarly qualified person to the satisfaction of the Regional District to be released upon final inspection by a landscape architect or other similarly qualified person to the satisfaction of the Regional District.
21. Garbage and recycling containers shall be screened with landscaping and solid gated fencing to a minimum height of 2.0 metres. Similarly, utilities, service kiosks, meters, elevator housing, exhaust elements, satellite dishes, etc. shall be screened with landscaping, fencing, or a combination of the two.
22. Decorative fences are encouraged which complement the materials used for the principle building.

Site Illumination and Signage

23. Lighting should be designated for security and safety. However, there should not be glare on neighbouring properties, adjacent roads, or the sky.
24. All new, replacement and upgraded exterior lighting in existing and proposed developments shall be Full Cut-off Flat Lens (FCO/FL) luminaries to light roads, parking, loading, and pedestrian areas. Exterior building lighting will also be required to have FCO lighting fixtures.
25. The size, location, and design of freestanding signage shall be architecturally integrated with the overall design of the buildings and landscaping. The design of fascia signs containing individual business signage shall be integrated into the design of the building. No video, neon, reader board, or LED signs will be supported.
26. The installation of fascia or projecting signs that are handcrafted, hand painted, and individually designed are strongly encouraged.
27. Signage should be visually unobtrusive and particular emphasis should be given to signage which is aesthetically pleasing and requires a minimal amount of lighting or boldness to be effective.
28. If there is a conflict between these DPA guidelines and the [RDN Sign Bylaw No. 993, 1995](#) as amended or replaced from time to time, these guidelines shall prevail. However, a variance to the sign bylaw may be required.

Pedestrian and Cyclist Considerations

29. Pedestrian sidewalks or defined pathways to encourage pedestrian movement throughout the site should be provided.
30. All internal pedestrian walkways shall be distinguished from driving surfaces through the use of a clearly delineated pathway or durable low maintenance surface material such as pavers, bricks, or concrete to enhance pedestrian safety and comfort as well as the attractiveness of the walkways.
31. Bicycle parking facilities should be provided at grade near primary building entrances.

5.1.12 Cedar Development Permit Area

Information Note: the designation of this development permit area and description of the special conditions or objectives that justify the designation are located in the Electoral Area A Official Community Plan.

APPLICATION

A development permit is required for the following activities unless specifically exempt:

1. Alteration of land and disturbance of soils;
2. Construction, alteration, or erection of buildings and structures; and,
3. Creation of non-structural impervious or semi-pervious surfaces;

EXEMPTIONS

1. A development permit shall not be required for the construction, renovation, or addition to one single or duplex dwelling unit or accessory residential building on one single lot.
2. The replacement or repair of an existing signs provided that the sign is not enlarged or moved and is replaced with the same type of sign (i.e. fascia, freestanding, canopy, etc.).
3. A development permit shall not be required for the subdivision of land.
4. A development permit shall not be required for alterations or additions to a building which do not require a building permit. This exemption excludes new signage which shall require a development permit.

GUIDELINES

General Design

1. The Regional District shall require building elevations prepared by an architect or other qualified designer.
2. Commercial development should be ground-oriented and in scale with the surrounding uses.
3. The use of non-combustible building materials is encouraged and where feasible, locally produced natural building materials should be incorporated in to the design without compromising the building or structure's fire resistance.
4. There shall be no net increase in peak rainwater run-off from the land to adjoining lands.
5. Development of land should be designed to:
 - a) Replicate the function of a naturally vegetated watershed;
 - b) Maintain the hydraulic regime of surface and groundwater and pre-development flow rates;
 - c) Not interfere with groundwater recharge; and,
 - d) Not introduce or remove materials where it would cause erosion of or the filling in of natural watercourses and/or wetlands.

5.1.10 Cedar Development Permit Area

6. Public open space and pedestrian walkway linkages to adjacent neighbourhoods, which complement existing parks and recreation opportunities and reduce automobile dependence, shall be encouraged.
7. The use of energy efficient building materials, techniques, and practices that reduce energy consumption shall be encouraged.

Parking and Loading

8. Parking and loading areas should generally be located to the rear of buildings, should be screened from view from the adjacent road, and be located outside of the minimum required zoning setback, unless a variance is being considered. The screening should consist of landscaping, fencing, or a combination of landscaping and fencing.
9. Vehicular and truck movement patterns must be illustrated on the site plan submitted by the applicant to ensure adequate circulation. A professional engineer may be required to ensure that adequate lane widths and turning radiuses are provided for all forms of vehicles intended to use the property.
10. Provision should be made for public transit, emergency vehicles, delivery and service vehicles.
11. Safe and effectively designed and located internal roadways, entrance points, parking areas, pedestrian paths and open spaces shall be provided.

Landscaping and Screening

12. The Regional District may require the applicant to submit a landscaping plan prepared by a landscape architect or equivalent designer which meets the British Columbia Landscape Standard and satisfies the following objectives:
 - a) To use a variety of drought tolerant deciduous and evergreen native plant species that are best suited to the site specific growing conditions;
 - b) To minimize water consumption through means such as micro-irrigation and xeriscaping;
 - c) To promote compatibility with surrounding residential uses;
 - d) To improve the aesthetic appeal of the development;
 - e) To assist in the safe movement of pedestrians throughout the site;
 - f) To reduce the amount of impervious surfaces on the site;
 - g) To shade the proposed development from the summer sun;
 - h) To complement the development and surrounding uses; and/or,
 - i) To establish or enhance habitat values on the development site where appropriate.
13. The landscaping plan must be drawn to scale and show the type, size, and location of proposed landscaping and shall be submitted with the development permit application.
14. To provide separation between residential and non-residential uses, a continuous landscaped buffer area of at least 2.0 metres in width along the inside of all property lines, excluding access points, adjacent to all residential zoned property should be provided.

15. Landscaping should be provided adjacent to all roadways to improve aesthetic appeal, minimize impervious surfaces, and provide a visual screen for all outdoor storage, refuse, parking, loading, and unloading facilities and must also work towards the objectives identified in Guideline 12 above.
16. Garbage and recycling containers shall be screened with landscaping and/or solid gated fencing to a minimum height of 2.0 metres. Similarly, utilities, service kiosks, meters, elevator housing, exhaust elements, satellite dishes, etc. shall be screened with fencing, landscaping, or a combination of the two.
17. Buildings and structures should be sited in a manner that minimizes the disturbance of existing native vegetation.
18. Vegetation species used in replanting, restoration, and enhancement shall be selected to suit the local soils; light conditions, and groundwater regime of the site and should be native to the area, and where applicable, selected for erosion control and/or fish and wildlife habitat values.
19. All landscaping shall require the following minimum depth of topsoil or amended organic soils on all landscaped areas of a property:
 - a) Shrubs – 45 cm;
 - b) Groundcover and grass – 30 cm; and,
 - c) Trees – 30 cm around and below the root ball.
20. Where irrigation is required to maintain proposed landscaping, it should be designed by an Irrigation Industry Association of British Columbia certified irrigation designer and be installed by an Irrigation Industry Association of British Columbia irrigation contractor or other equivalent to the satisfaction of the Regional District.
21. The Regional District shall require the applicant to submit a landscaping and security deposit equal to the total estimated costs of all materials and labour, as determined by a landscape architect or other similarly qualified person to the satisfaction of the Regional District, to be released upon final inspection by a landscape architect or other similarly qualified person to the satisfaction of the Regional District.
22. Chain link fencing shall be used only when screened by landscaping. Decorative fences are encouraged which complement the materials used for the principle building.

Site Illumination and Signage

23. Lighting should be designated for security and safety. However, there should not be glare on neighbouring properties, adjacent roads or light directed towards the sky.
24. All new, replacement, and upgraded exterior lighting in existing and proposed developments shall be Full Cut-off Flat Lens (FCO/FL) luminaries to light roads, parking, loading, and pedestrian areas. Exterior building lighting will also be required to have FCO lighting fixtures.
25. The size, location, and design of freestanding signage shall be architecturally integrated with the overall design of the buildings and landscaping. The design of fascia signs containing individual business signage shall be integrated into the design of the building.
26. Signage should be visually unobtrusive and particular emphasis should be given to signage which is aesthetically pleasing and requires a minimal amount of lighting or boldness to be effective.

5.1.10 Cedar Development Permit Area

27. If there is a conflict between these DPA guidelines and the [RDN Sign Bylaw No. 993, 1995](#) as amended or replaced from time to time, these guidelines shall prevail. However, a variance to the sign bylaw may be required.

Pedestrian and Cyclist Considerations

28. Pedestrian sidewalks or defined pathways connecting building entrances to and through parking areas and sidewalks or road right of ways of the adjacent streets should be provided.
29. All internal pedestrian walkways shall be distinguished from driving surfaces through the use of a clearly delineated pathway or durable, low maintenance surface material such as pavers, bricks, or concrete to enhance pedestrian safety and comfort, as well as the attractiveness of the walkways.
30. Bicycle parking facilities should be considered at grade near primary building entrances

5.1.13 Extension Village Centre – Commercial Development Permit Area

Information Note: the designation of this development permit area and description of the special conditions or objectives that justify the designation are located in the Arrowsmith Benson – Cranberry Bright Official Community Plan.

APPLICABILITY

Prior to commencing the construction of, addition to, or alteration of a building or structure the owner must obtain a development permit in accordance with the Village Centre – Commercial, Development Permit Area Guidelines.

EXEMPTIONS

A development permit is not required for the following:

1. construction, alteration or addition to a building or structure utilized for non-commercial purposes including home based businesses, public utility uses or park uses;
2. internal alterations to an existing building or structure;
3. excluding signs and awnings, building additions or alterations which do not affect more than 20 percent of the area of a building face or increase gross floor area by more than 20 percent;
4. canvas awnings provided no portion exceeds 4.0 metres in height as measured from finished grade and the vertical or horizontal extent of the awning does not exceed 1.5 metres;
5. unlit or front lit, suspended, projecting signs provided the sign face does not exceed one (1) square metre and the distance between the sign faces does not exceed 0.1 metre;
6. unlit or front lit signs consisting solely of physically separate letters or symbols attached directly to a building exterior or awning and occupying a rectangular area of not more than one (1) square metre; or
7. subdivision of land.

GUIDELINES

1. All new buildings must be massed to give the impression of small blocks.
2. The architectural design and scale of new buildings must integrate with and enhance the residential character of surrounding buildings.
3. An addition to an existing building must integrate with the overall architectural design and scale of the building.
4. Building elevations, which are visible from the street, must be treated as front elevations for the purpose of ensuring that buildings do not turn their backs on the street. The treatment of these elevations need not be as extensive as the actual front elevation but should promote visual harmony especially in regards to streetscapes.
5. The main pedestrian entrance of a building must face the street, and have direct and continuous pedestrian access to the street.

5.1.13 Extension Village Centre – Commercial Development Permit Area

6. Developments must incorporate pedestrian traffic routes along public road frontages and should provide covered walkways to shelter pedestrian movements.
7. On site pedestrian walkways and public pedestrian traffic routes must be hard surfaced.
8. Where possible, off-street parking areas must be located behind the building so that the building screens the parking area from the road.
9. Vehicle accesses should be consolidated where possible.
10. Buildings and structures should be sited in a manner that minimizes the disturbance of existing natural vegetation.
11. Landscaping must be comprised primarily of native species, which enhance the architectural characteristics of the development.
12. Signs must be unobtrusive, grouped whenever possible and designed in such a manner as to be complementary to the architectural design and scale of surrounding development.
13. Site lighting must not utilize high-intensity lights and must be ornamental and in scale with a pedestrian environment. The use of metal halide lighting is encouraged.
14. Garbage containers, loading, unloading and storage areas must be screened from public view.

5.1.14 East Wellington – Pleasant Valley Industrial Development Permit Area

Information Note: the designation of this development permit area and description of the special conditions or objectives that justify the designation are located in the East Wellington – Pleasant Valley Official Community Plan.

GUIDELINES

1. A Development Proposal shall be submitted with the Development Permit application. The proposal should generally provide the following information, in the form of plans and/or written documents:
 - a) detailed site plan illustrating existing and proposed buildings and structures, topographical features and existing natural vegetation;
 - b) detailed plans of proposed buildings and structures;
 - c) detailed storm water management plans; and
 - d) detailed landscaping plan indicating the location, number and type of proposed plantings.
2. Off-street parking should be located to the rear or sides of buildings and structures wherever possible. Off-street parking proposed to be located to the front of buildings and structures should be suitably screened with a landscape screen.
3. Outside storage and manufacturing areas should be located to the rear of the buildings and structures and be suitably landscaped with a landscape screen.
4. Buildings and structures should be sited and shaped in such a manner as to be visually unobtrusive.
5. Signage should be visually unobtrusive and grouped wherever possible. Particular emphasis should be given to signage, which is aesthetically pleasing and has a minimal amount of lighting and specifically excludes neon lighting.
6. Where land use activities involve the handling, storage or manufacture of potential contaminants, provision shall be made that will prevent seepage of such contaminants into the subsurface. All provisions shall be approved by the appropriate provincial agency prior to issuance of a development permit. All parking facilities shall be equipped with oil/water separators.
7. Any new development shall not negatively impact storm water quality or quantity.
8. Facilities for the proposed storage and distribution of propane from tanks or vessels over an aggregate volume of 19,000 litres shall be required to meet the following:
 - a) have located on site one approved fire extinguisher having a minimum capacity of 8.0 kilograms of dry chemical with a BC rating;
 - b) meet all requirements of the *Gas Safety Act* and regulations adopted thereto;
 - c) additional fire protection measures may be required in compliance with the NFPA Standard for the Storage and Handling of Liquefied Petroleum Gases; and
 - d) plans shall be forwarded to the Fire Chief of the local fire protection department for review and comment.

5.1.15 Nanoose Bay Form and Character Development Permit Area

Information Note: the designation of this development permit area and description of the special conditions or objectives that justify the designation are located in the Nanoose Bay Official Community Plan.

EXEMPTIONS

1. A development permit shall not be required to construct, renovate or alter a single dwelling unit or building or structure accessory to a single dwelling unit.
2. A development permit shall not be required to construct an accessory building to a multiple dwelling unit development where the proposed accessory building is 10 m² or less in size and 3 m in height.
3. A development permit shall not be required for interior alterations or repairs.
4. A development permit shall not be required for the subdivision of land.

GUIDELINES

1. The character of commercial development will generally:
 - a) Be designed and situated to maximize views wherever possible;
 - b) integrate with and enhance the character of existing development;
 - c) incorporate natural materials into the design of the buildings;
 - d) be designed to maximize the use of the existing topography and natural landscaping; and
 - e) incorporate crime prevention and public safety features.
2. The character of multi-unit residential development will generally:
 - a) be in keeping with the character of the village centre and surrounding rural and residential lands;
 - b) provide a range of housing types and options;
 - c) be developed to a height that maintains 'human scale' (generally less than three storey);
 - d) be ground oriented;
 - e) be designed to maximize the use of the existing topography and natural landscaping;
 - f) incorporate natural building materials into the design of the buildings; and
 - g) be designed and situated to maximize views wherever possible.
3. Safe pedestrian and cycling routes shall be provided through and to commercial or multi-unit residential developments and shall link to existing neighborhoods, parks and the waterfront.
4. Introduced landscaping shall use native plantings, drought tolerant species, and xeriscaping standards, where possible.

5.1.15 Nanoose Bay Development Permit Area

5. Off-street parking areas shall primarily be located to the rear or side of buildings and include landscape areas or screening.
6. Any outside storage or manufacturing areas shall be located to the rear of buildings unless adequately screened with landscaping.
7. Where appropriate, pedestrian facilities shall be provided to separate pedestrian and traffic circulation on a site and minimize vehicle/pedestrian conflicts.
8. Building and site design should include "public gathering places" (e.g. outdoor plazas) and encourage pedestrian uses. The use of small seating areas, entry areas, plazas, and other meeting places in conjunction with pedestrian areas is encouraged.
9. Where appropriate, cycling facilities should be provided through safe circulation paths with sheltered locations for bicycle security.
10. Signage shall complement the design of buildings and structures and be grouped on multiple development sites. The use of natural materials is encouraged.
11. The use of indirect lighting on signage is encouraged.
12. Walls, fences, shrubs, grade changes or other site features should not obscure vehicle driver vision of pedestrian or bicycle routes or provide for concealment.
13. Applications to rezone land within a village or neighbourhood centre shall be evaluated, at a minimum, on how the following elements are proposed to be incorporated into the development and shown to be compatible with the centre:
 - a) a mix of uses;
 - b) building and landscape architectural themes;
 - c) concept design of public space;
 - d) public park land requirements;
 - e) road standards;
 - f) pedestrian facilities;
 - g) treatment of utilities (i.e., street lighting, hydro, etc);
 - h) methods of integrating existing and new developments; and
 - i) where a Village Centre Plan has been prepared for the Red Gap Village Centre, how the development proposal responds to the elements of the Village Centre Plan.

5.1.16 Qualicum Bay and Dunsmuir Village Centres Development Permit Area

Information Note: the designation of this development permit area and description of the special conditions or objectives that justify the designation are located in the Electoral Area H Official Community Plan.

APPLICABILITY

A development permit is required for the following activities wherever they occur within the development permit area, unless specifically exempted:

1. Construction, erection, renovation or addition of buildings or structures on the land, including signage over 1.0 meters in height.
2. Alteration of land, removal of vegetation, disturbance of soils, including grubbing, scraping and removal of top soil.

EXEMPTIONS

The following activities are exempt from any requirement for a development permit:

1. Exemptions listed in Section 8.3 Development Permit Areas – General Exemptions.
2. Construction, renovation, or addition to single dwelling unit, duplex dwelling unit, or accessory residential buildings.
3. Alterations or additions to a building which does not require a building permit. This exemption excludes new signage.
4. Addition to an existing building or structure that is not visible from a public roadway or other public spaces.
5. Subdivision of land except for intensive residential which for the purpose of this exemption, means any residential development with an average minimum parcel size less than 2,000 m² or density greater than five dwellings per hectare whether fee simple or strata.
6. Maintenance of existing landscaping, existing roads, parking areas, paths and trails.
7. Construction of unpaved driveways and walkways not exceeding 4 meters in width.

GUIDELINES

1. For Qualicum Bay Village Centre, tourist and business frontage for the Village shall be encouraged to be oriented toward the central portion of District Lot 20, Newcastle District and shall provide linkage and integration with the existing commercial lands along the Island Highway No. 19A and institutional uses including the Lighthouse Community Hall, seniors housing and park land.
2. For Dunsmuir Village Centre, the tourist and business frontage for the Village shall be encouraged to be oriented toward Horne Lake Road and existing commercial areas along the Island Highway No. 19A. New development shall provide pedestrian and vehicle linkages with the existing residential areas and currently vacant lands adjacent to Horne Lake Road.

3. The character of commercial development will generally:
 - a) be integrated with and enhance the character of the existing development,
 - b) be designed with a mix of commercial building styles, and constructed as small scale, low-rise structures that are clustered together,
 - c) be oriented toward adjacent streets where possible, and
 - d) be designed to have separate buildings or buildings that appear as small, individual buildings rather than a single large building.
4. The character of multi-family development will generally:
 - a) be in keeping with the village character and surrounding residential or rural areas,
 - b) provide a range of housing types,
 - c) be clustered in small groups,
 - d) provide pedestrian linkages to areas beyond the development,
 - e) be ground oriented wherever possible; and
 - f) incorporate landscaping to separate residential clusters.
5. Incorporating natural materials to create a “west coast” style into the design is encouraged.
6. Safe pedestrian and cycling routes that connect the property with the waterfront, open spaces and active transportation networks shall be identified and where applicable, constructed in accordance with the Regional District’s Community Parks and Trails Strategy, Regional Parks and Trails Plan, or Active Transportation Plan, and any subsequent editions.
7. Walls, fences, shrubs, grade changes or other site features should not obscure the vision of vehicle drivers with respect to pedestrians or bicycle routes.
8. Development shall not be separated or ‘gated’ with walled or fenced enclaves.
9. Off-street parking and off-street loading areas shall be located to the rear of buildings wherever possible, shall be complimentary to the development, and shall be screened with landscaping. Small clustered parking areas are preferable to large paved areas.
10. Off-street parking and off-street loading areas, located adjacent to residential or rural land uses, shall be adequately screened from the residential uses.
11. All outdoor refuse and storage areas shall be screened with a combination of landscape plants and fencing, and wherever possible, located to the rear of the buildings or in unobtrusive locations. For waterfront properties, consideration should also be given to screening these areas from the beach front.
12. Sites and buildings must be designed to use best practices for integrated rainwater management and water conservation techniques, including appropriate source controls such porous and permeable surfaces, bioswales, absorbent landscaping, infiltration facilities, re-use systems and other techniques. Water quality should be maintained by ensuring that no deleterious substances enter ground or surface water. Rainwater should be managed onsite wherever

possible, and management approaches should be aligned with *Develop with Care: Environmental Guidelines for Urban and Rural Land Development in British Columbia*, published by the B.C. Ministry of Environment, or any subsequent editions. The Regional District may require a rainwater management plan prepared by a professional engineer or other qualified professional.

13. Applicants are encouraged to refer to the most recent edition of the British Columbia Landscape Standards published by the BC Society of Landscape Architects when creating their plan. Landscaping should be used in site design to achieve the following list of objectives:
- a) retain existing healthy, mature trees to provide shading and enhance the streetscape;
 - b) new plantings should consist of indigenous vegetation or other non-invasive vegetation suitable for local environmental conditions;
 - c) utilize a variety of native plants that are drought tolerant suitable to local growing conditions;
 - d) enhance the pedestrian experience (e.g., aesthetics, weather conditions, safe movement throughout site and visual separation from and between uses) and compliment the development and surrounding area;
 - e) add texture and three dimensional components to the site (e.g., ground level planting, raised beds, shrubs, tree canopy) and avoid creating areas that are predominately bark mulch, gravel or other similar materials;
 - f) minimize water consumption through conservation techniques such as micro-irrigation and xeriscaping;
 - g) respect required sightlines from roadways and enhance public views;
 - h) help screen parking areas, electrical and mechanical features, and refuse and recycling facilities; and
 - i) contribute to a sense of personal safety and security.
14. The design and layout of open spaces that can accommodate buildings and areas for edible landscapes and food production are encouraged (e.g., planter boxes, green house, compost facility, private and/ or community gardens, arbours and associated planting, bee hives.)
15. Where the introduction of vegetation is required within the development permit area, the Regional District may require the applicant to submit a landscape plan and security deposit equal to the total estimated costs of all materials and labour as determined by a landscape architect or other qualified person to the satisfaction of the Regional District.
16. Exterior lighting shall be low intensity, pedestrian-oriented with an emphasis on public safety and the prevention of glare onto adjacent properties, roads or sky. The use of solar power lighting is encouraged.
17. All new or replacement exterior lighting in commercial areas shall use Full-Cut Off/Flat Lens (FCO/FL) lighting fixtures on exterior to light roads, parking, loading and pedestrian areas.
18. Signs should be visually unobtrusive, grouped wherever possible and primarily pedestrian-oriented, designed at a pedestrian scale. Handcrafted signs of a professional quality, designed to be effective with minimal lighting and integrated into the overall design of the building and landscape are preferred.

5.1.16 Qualicum Bay and Dunsmuir Village Centres Development Permit Area

19. For land to be developed where a commercial property abuts residential zoned property(s), a landscaped buffer area should be provided between the commercial property and the residential property(s) to provide a visual screen.
20. For land to be developed that is adjacent to or adjoining an Agricultural Land Reserve boundary a buffer area containing vegetation or fencing or a combination of both shall be retained, or established and maintained. All buffer areas shall generally be designed and landscaped using materials set out in Guide to Edge Planning: Appendix B, published by the BC Ministry of Agriculture, or any subsequent editions.

5.1.17 Bowser Village Centre Development Permit Area

Information Note: the designation of this development permit area and description of the special conditions or objectives that justify the designation are located in the Bowser Village Centre Plan.

APPLICABILITY

A development permit is required for the following activities wherever they occur within the development permit area, unless specifically exempted:

1. alteration of land, placement of fill, disturbance of soils, including grubbing, scraping and the removal of top soils;
2. construction of, addition to, or alteration of a building or structure;
3. creation of non-structural impervious or semi-pervious surfaces; and
4. subdivision of land as defined in the Land Title Act or Strata Property Act.

EXEMPTIONS

The following activities are exempt from any requirement for a development permit:

1. Construction, renovation, or addition to a single dwelling unit, detached secondary suite or duplex dwelling unit.
2. Addition to an existing building or structure that is not visible from a public road way or other public spaces.
3. The replacement or repair of an existing sign providing the sign is not enlarged or moved and is replaced with the same type of sign (i.e., fascia, freestanding, etc).
4. Subdivision of land as defined in the *Land Title Act* or *Strata Property Act*, except for intensive residential⁵.
5. Maintenance and minor modifications to existing landscaping, existing roads, parking areas, paths and trails.
6. Construction of unpaved driveways and walkways not exceeding 4 meters in width.
7. Works conducted by the Regional District or its agents where appropriate measures have been undertaken to satisfy the applicable development permit area guidelines as determined by the Regional District.

⁵ For the purpose of this DPA, intensive residential shall mean any residential development with an average minimum parcel size less than 2000 m² or density greater than 5 dwelling units per hectare, whether fee simple or strata.

GUIDELINES

Context and Regional Expression

1. Incorporate form and images that relate to the natural and cultural landscape of Bowser by integrating one or more of the following themes:
 - a) Lighthouse Country
 - b) First Nations History
 - c) Post 1900’s historical themes such as logging, fishing and shellfish aquaculture
 - d) Connect to water such as Thames Creek, Strait of Georgia, surface water and aquifers
 - e) West coast influenced design incorporating BC wood products
2. Through building design and placement, address sunlight penetration, natural ventilation, and protection from different weather elements to improve the pedestrian experience in commercial areas (e.g., covered walkways, awnings, canopies, overhangs, pergolas and shade trees).
3. Protect and enhance public views of landmarks, buildings, open spaces, natural features and the ocean through careful building siting, height and form.

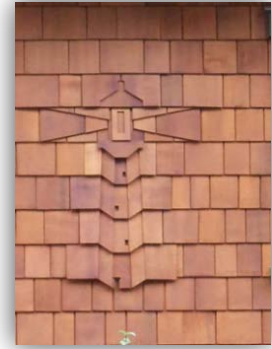

Example of desired design detail.

Human Scale

4. Design from human scale and visual interest in all building elevations. This can be achieved by placing an emphasis on street facing building entrances, windows and landscaping relative to walls and building structure.
5. Mixed use and commercial buildings shall be located in close proximity to the sidewalks and pedestrian spaces.
6. Where mixed use or commercial buildings are proposed, avoid large spaces between buildings.
7. The use of drive-through shall not be a part of building or site design.
8. Design, siting and construction of sidewalks or paths in the road right-of-way shall be consistent with the Active Transportation Plan for Electoral Area H, 2017 or provide rationale for taking a different approach as presented in that Plan. Note that approval from the Ministry of Transportation and Infrastructure is required for works in the road right-of-way.



Example of mixed-used building, orientated to the street with covered walkway.



Example of building articulation, varying rooflines & exterior architectural design detail.

Building Massing, Height and Form

9. Larger buildings (e.g., > 12meters in width) shall be designed to avoid large, flat building expanses by creating multiple, separate buildings such that individual buildings appear as many small buildings that are compatible in shape, mass, and exterior finishes. Consider using building articulation, visually-interesting rooflines (e.g., variations in cornice lines and roof slopes); architectural elements (e.g., balconies, bay windows, cupolas, dormers), and other detailing that creates rhythm along the lines of the building.
10. Utilize landscaping treatments to further soften the mass of building form (e.g., strategic location of trees, hedge borders, trellis and surface materials such as pavers).
11. On slopes, building design should step with the natural topography. Building form should depict a series of buildings nested into the hillside, rather than a single, uniform building form.

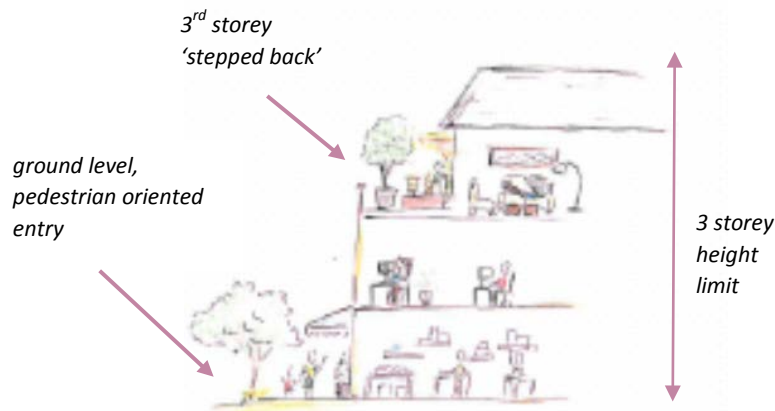

12. Building height is limited to a maximum of 12 meters (i.e., 3 storeys) unless otherwise specified.
13. Where building height is 12 meters (i.e., 3 storeys), incorporate step back and/or terrace above the second floor to reduce visual impact and to strengthen the pedestrian-scale of the building.
14. Development shall not be separated or 'gated' with walled or fenced enclaves.

Building Style & Exterior Materials

15. High quality, functional exterior finishes suited to a west coast climate should be used to ensure the integrity of the building envelope and to present an attractive appearance.
16. Natural, local non-combustible materials should be used to the greatest extent possible, with an emphasis on British Columbia wood products.
17. Use exterior colours that are found in or complement the area's natural and cultural landscape.



Example of different materials and colours used in combination to create contrast and to reduce massing of a prominent building in the Qualicum Beach village center.

5.1.17 Bowser Village Centre Development Permit Area

18. Use materials in combination to create contrast, enhance human scale and reduce massing of a building.

Signs, Canopies & Lighting

19. Signs should be visually unobtrusive, grouped wherever possible and primarily pedestrian-oriented, designed at a pedestrian scale. Handcrafted signs of a professional quality, designed to be effective with minimal lighting and integrated into the overall design of the building and landscape are preferred.

20. The following types of signage shall be encouraged:

- a) projecting two dimensional signs suspended from canopies, awnings or overhangs,
- b) externally, front lit signs especially with LED lighting,
- c) fascia signs integrated into the design of the building,
- d) letter signs mounted on storefronts, and
- e) carved wooden signs.

21. The following types of signage shall be avoided:

- a) awnings as signs or large signage on awnings (letter heights over 30 cm/12 inches),
- b) internally lit, plastic face, aluminum box style signage,
- c) animated, flashing, oscillating or moving signs,
- d) pylon (stand alone) signs, and
- e) roof top signs.

22. Continuous weather protection for pedestrian's comfort should be provided in commercial areas (e.g., awnings, canopies, overhangs, pergolas and shade trees). All design elements should complement the overall building and public realm.

23. Exterior lighting shall be low intensity, pedestrian-orientated with an emphasis on public safety and the prevention of glare onto adjacent properties, roads or sky. The use of solar power lighting is encouraged.



Examples of desired signage that is attractive and informative for both pedestrians and the travelling public.



Example of undesirable signage within the Bowser Village Center.

5.1.17 Bowser Village Centre Development Permit Area

24. All new or replacement exterior lighting in commercial areas shall use Full-Cut Off/Flat Lens (FCO/FL) lighting fixtures on exterior to light roads, parking, loading and pedestrian areas.
25. Light fixtures should be concealed, unless they are decorative and then the style shall be consistent with the design and character of the building.

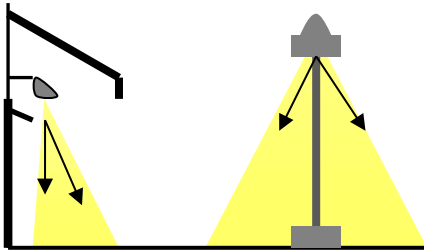

Examples of Full-Cut Off Lighting and decorative exterior lighting.

Outdoor Public Open Spaces

26. Outdoor patios and dining areas should be designed to create a compatible and complementary relationship with the adjacent streetscape, building architecture, and uses. These spaces should be well defined by landscaping, decorative fencing or other vertical barriers while being generally open and visible from public areas.
27. Public art or features should be considered for public plazas and courtyards.
28. All play areas for children should have adequate shade and seating for adults.
29. The retention of natural features (like trees, rock or other landscape features) in open spaces shall be encouraged.
30. Street furniture to enhance the pedestrian experience, such as benches, decorative street lamps, bicycle racks and refuse containers shall be incorporated in the landscape design. These shall be required to be consistent, similar, or identical in character to the architectural character of the development and identified by type and source in the application.



Examples of decorative street furniture with complementary landscaping to define public outdoor spaces.

Accessibility & Connectivity

31. Universal design principals shall be employed to ensure meaningful access for people of all ages, stages and abilities, including children, parents, older adults and seniors. Meaningful, access is

5.1.17 Bowser Village Centre Development Permit Area

determined by the users' complete experience of a building, connecting pathways, sidewalks, entrances, doors and hallways. Features include things such as accessible, barrier-free travel routes to the main building entry, smooth, ground-level entrances without stairs, and wide interior doors and hallways. Consider those using such equipment as wheelchairs, other walking-aids, strollers and bicycles.

32. Accessible travel routes shall be provided that incorporate transitions between public walkways, together with private walkways, parking areas, retail shops and services, and roads to provide seamless and interesting access for all users, including those of different ages and abilities.



Example of accessible, laneways that connect commercial areas to public/social spaces.

Crime Prevention

33. Best practices for “Crime Prevention through Environmental Design” should be incorporated into building design, such as:

- a) Natural surveillance, ‘eyes on the street’: visibility, light and openness should maximize the ability to see throughout the site through placement of windows that access all areas, appropriate lighting to avoid darken spaces and walkways, entrances and site features should be designed to avoid areas for hiding.
- b) Define spaces: creating a clear definition between public and private space that express ownership and boundaries, particularly for multi-residential and mixed-use developments.
- c) Active Spaces: Encourage legitimate activity in public spaces by locating uses in complementary arrangements. Avoid spaces that appear confined, isolated, or unconnected, or appear without a clear purpose or function.

Green & Healthy Buildings

- 34. Evaluate site design for passive solar gain and cooling opportunities (e.g., passive solar water heating, solar mass wall, passive solar heating of intake air). On sites with substantial solar exposure, buildings should be sited, designed, and landscaped to take advantage of passive solar gain in winter and reduce sun exposure in summer.
- 35. Minimize exposure to noise and pollution through site and building design, especially for those developments located along busy roads (e.g., triple-pane glazing, orient courtyards, playgrounds, open spaces, and building air intakes away from the road).
- 36. Utilize sustainable construction methods and materials, including the reuse, rehabilitation, restoration, and recycling of buildings and/or building elements.
- 37. All new commercial, mixed-use, and multi-unit residential buildings within the development permit area are encouraged to be efficient and healthy, and are encouraged to seek third party certification, such as Built Green Gold or Leadership in Energy and Environmental Design (LEED). The Regional District may be able to provide assistance in the planning process and may offer financial assistance in accordance with Regional District’s environmental rebate and grant programs.
- 38. The design and layout of open spaces that can accommodate buildings and areas for edible landscapes and food production are encouraged (e.g., planter boxes, green house, compost facility, private and/ or community gardens, arbours and associated planting, bee hives).
- 39. The installation of electric vehicle charging stations are encouraged. The Regional District may be able to provide assistance in the planning process and may be able to identify applicable rebate and grant programs.

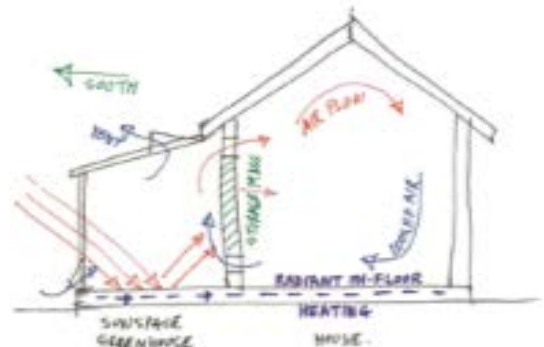

Example of a passive solar gain designed house.

- 38. The design and layout of open spaces that can accommodate buildings and areas for edible landscapes and food production are encouraged (e.g., planter boxes, green house, compost facility, private and/ or community gardens, arbours and associated planting, bee hives).
- 39. The installation of electric vehicle charging stations are encouraged. The Regional District may be able to provide assistance in the planning process and may be able to identify applicable rebate and grant programs.

Relationship to the Street

- 40. Orient residential and commercial buildings to face the street.
- 41. Commercial and mixed-use buildings should be sited within close proximity to sidewalks and the pedestrian space to enhance the pedestrian experience, unless where a setback may be considered to provide transition to adjacent building or pedestrian-friendly features such as a patio, courtyard or plaza.
- 42. Building setbacks from lot lines should:
 - a) be designed to create an intimate, pedestrian friendly streetscape;



Example of an animated, mixed-use streetscape that provides a buffer between pedestrians and road traffic.

5.1.17 Bowser Village Centre Development Permit Area

- b) be between 0.0 m and 3.0 m (RDN in collaboration with MOTI will determine minimum building setbacks from lot lines);
- c) consider relationship and transition to adjacent buildings;
- d) corner sites are encouraged to feature landmark design or alternatively to provide a semi-public or public open space; and
- e) include “corner cuts” or similar treatment to expand sidewalks adjacent to intersections.



Example of site plan demonstrating a “corner cut”.



Example of site plan demonstrating a ‘woonerf’ style streetscape.

- 43. Pedestrian sidewalks or defined walkways connecting building entrances to and through parking areas and sidewalks or road right-of-ways of the adjacent streets shall be provided.
- 44. All internal pedestrian walkways shall be distinguished from driving surfaces through the use of a clearly delineated pathway or durable, low maintenance surface materials such as pavers, bricks, or concrete to enhance pedestrian safety and comfort, as well as the attractiveness of the walkways.
- 45. In residential areas, side street should consider ‘woonerf’ style streets that integrate needs of multiple users such as walking, cycling, playing, gardening and socializing.
- 46. Pedestrian sidewalks or defined walkways connecting building entrances to and through parking areas and sidewalks or road right-of-ways of the adjacent streets shall be provided.

Pedestrian Access, Provisions for Cyclists Circulation, Vehicles and Loading

- 47. Clearly defined, safe pedestrian access shall be provided through sites and parking areas to maintain a pattern of active transportation that is integrated with building entrances, walkways, sidewalks, trails and adjacent streets.
- 48. Locate parking areas to the rear of buildings, internal to the building, or below grade.
- 49. Avoid large expanses of parking. Provide paved surfaces with visual interest and landscaped areas to create safe pedestrian walkways and visual breaks between clusters of parking stalls (approximately every seven stalls).

5.1.17 Bowser Village Centre Development Permit Area

- a) retain existing healthy, mature trees and new plantings should consist of indigenous vegetation or other non-invasive vegetation suitable for local environmental conditions;
- b) utilize a variety of native plants that are drought tolerant suitable to local growing conditions;
- c) enhance the pedestrian experience (e.g., aesthetics, weather conditions, safe movement throughout site and visual separation from and between uses) and compliment the development and surrounding area;
- d) add texture and three dimensional components to the site (e.g., ground level planting, raised beds, shrubs, tree canopy) and avoid creating areas that are predominately bark mulch, gravel or other similar materials;
- e) minimize water consumption through conservation techniques such as micro-irrigation and xeriscaping;
- f) respect required sightlines from roadways and enhance public views;
- g) help screen parking areas, electrical and mechanical features, and refuse and recycling facilities;
- h) contribute to a sense of personal safety and security;



Example of a vertical green wall system.

57. Mitigate undesirable architectural elements (e.g., blank walls can be covered with trellis and vines).
58. Minimize water consumption through conservation techniques such as micro-irrigation and xeriscaping. Landscaping is to meet the minimum depth of topsoil or amended organic soil on all landscaped areas of a property:
- a) Shrubs – 45 cm,
 - b) Groundcover and grass – 30 cm, and
 - c) Trees – 30 cm around and below the root ball.
59. Landscape plans must be drawn to scale and show type, size and location of proposed landscaping works and planting materials and shall be submitted with the development permit application.

5.1.17 Bowser Village Centre Development Permit Area

60. Where irrigation is required to maintain proposed landscaping, it should be designed and installed by an Irrigation Industry Association of British Columbia certified irrigation designer or another qualified person.

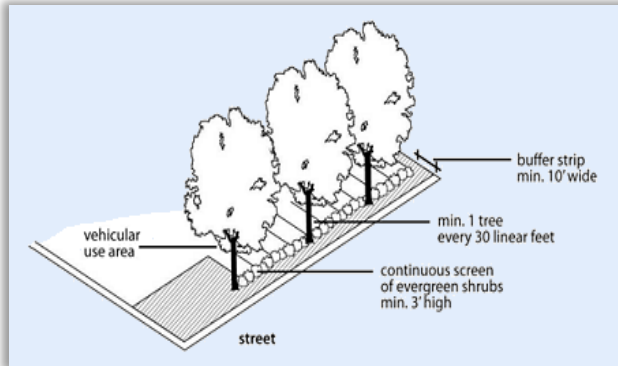

Example of landscaped buffer from street or between residential properties.

Example of decorative fencing and landscaped screening.

61. Where a commercial property abuts residential zoned property, landscaped buffer area should be provided between the commercial property and the residential property(s).

62. High-efficiency, water saving, automatic irrigation systems are encouraged.

63. All refuse and recycling facilities shall be screened with landscaping and/or gated fencing to a minimum 2.0 meters. Similarly, utilities, electrical and mechanical features shall be screened with fencing, landscaping or a combination of the two.

64. Decorative fences are encouraged. Where chain link fencing used, it shall be screened with landscaping.

Rainwater Management

65. Design sites and buildings to use best practices for integrated rainwater management and water conservation techniques, including appropriate source controls such porous and permeable surfaces, bioswales, absorbent landscaping, infiltration facilities, and re-use systems and other techniques aligned with Develop with Care: Environmental Guidelines for Urban and Rural Land Development in British Columbia, 2014, published by the B.C. Ministry of Environment, or any subsequent editions.



Examples of a rain garden and rainwater harvesting system.

5.1.17 Bowser Village Centre Development Permit Area

- 66. Water quality should be maintained by ensuring that no deleterious substances enter ground or surface water.
- 67. The Regional District may require a rainwater management plan prepared by a Professional Engineer or other qualified professional.
- 68. New buildings are encouraged to include non-potable water harvesting in the form of rainwater catchment or green roofs.

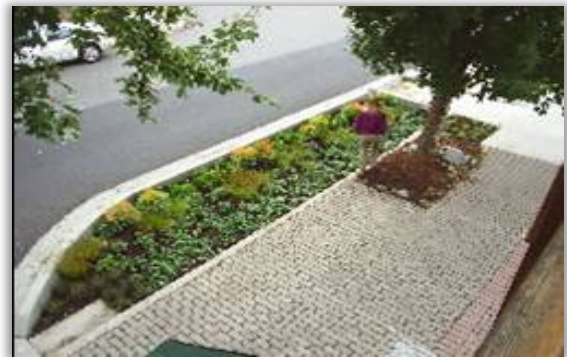
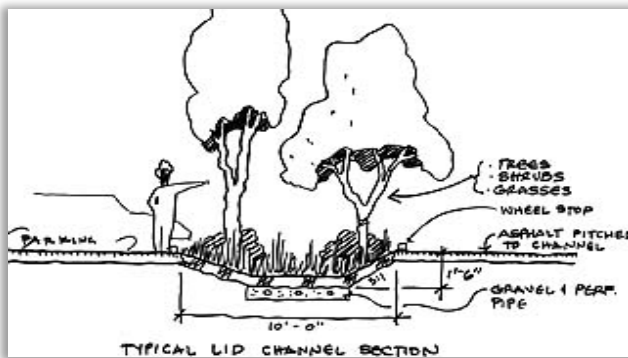

Examples of bioswales, permeable surfaces and absorbent landscaping.

Multi-Residential and Intensive Residential Development Guidelines

- 69. Residential units should be clustered to make the most efficient use of land and preserve as much land as possible for open space.
- 70. Residential land uses should be arranged to achieve gradual transition and minimize conflicts with adjacent housing types and surrounding neighbourhoods.
- 71. Residential units shall be designed to allow residents privacy as well as a sense of community such that each unit has at least one private outdoor space with access to or views of adjacent semi-public spaces.
- 72. Use landscaping and design to clearly distinguish and provide transitions between public and private spaces especially where residential uses are mixed with commercial uses.
- 73. Children’s play areas should be located to facilitate ‘natural surveillance’ with high visibility from residential units.

Additional Commercial Mixed-Use Development Guidelines

- 74. The maximum floor area for individual retail and commercial units should be 300 m² with the exception of grocery stores where a maximum 1,500 m² of retail space will be allowed.
- 75. Building size for institutional and commercial service/light industrial uses shall be a maximum 1,000 m².



Example of mixed-use building with third floor roofscape.

Additional Service Commercial/Light Industrial Development Guidelines

76. Retail and office uses in commercial service development should be ground oriented, located adjacent to the street with non-retail functions located to the rear of the property.
77. Residential 'live-work' units shall be located above street level over top of commercial service uses.
78. Where possible residential 'live-work' units should be oriented to overlook public streets.
79. Residential 'live-work' units shall have at least one private outdoor space with access to or views of adjacent semi-public spaces.

5.1.18 Multi Residential, Intensive Residential, Industrial and Commercial Form and Character Development Permit Area

Information Note: the designation of this development permit area and description of the special conditions or objectives that justify the designation are located in the Electoral Area G Official Community Plan.

APPLICATION

A development permit is required for the following activities unless specifically exempt:

1. alteration of land, placement of fill, disturbance of soils, including grubbing, scraping, and removal of top soils;
2. construction or erection of buildings and structures;
3. creation of non-structural impervious or semi-pervious surfaces; and
4. subdivision as defined in the *Land Title Act* or the *Strata Property Act*.

EXEMPTIONS

The following activities are exempt from requiring a development permit:

1. Single residential development and accessory uses, including subdivision, on lands zoned for single residential use.
2. The cutting down of hazardous trees in accordance with the recommendations contained in a report prepared by an Arbourist or other qualified professional. Trees must pose an immediate threat to the safety of persons or existing buildings or structures.

GUIDELINES

Servicing

1. Prior to any phase of a proposed development, the developer must provide a report prepared by a registered professional engineer that provides the following:
 - a) detailed plans and specifications showing the proposed sewage connection or disposal system (in unserviced areas) and rainwater drainage systems to be constructed to service the proposed development;
 - b) on lands serviced by community water, proof that the proposed development will be connected to the community water system and that the proposed system is compatible with the adjacent municipality's engineering standards; and,
 - c) on lands serviced with community sewer, proof that the proposed development will be connected to the community sewer system and that the proposed system is compatible with the adjacent municipalities engineering standards.

General Design

2. The Regional District of Nanaimo shall require an applicant to submit building elevations prepared by an architect or other qualified professional.
3. Commercial development should be ground oriented and in scale with the surrounding uses.
4. The use of non-combustible building materials is encouraged and where feasible locally produced natural building materials should be incorporated in to the design without compromising the building or structures fire resistance. West Coast architecture is strongly encouraged.
5. There shall be no net increase in peak rainwater run-off from the land to adjoining lands.
6. Development or subdivision of land should be designed to:
 - a) replicate the function of a naturally vegetated watershed;
 - b) maintain the hydraulic regime of surface and groundwater and pre-development flow rates;
 - c) not interfere with groundwater recharge;
 - d) not introduce or remove materials where it would cause erosion of or the filling in of natural watercourses and/or wetlands.
7. Benches, ornamental street lights, and public art are encouraged throughout the site. Outdoor patios or amenity areas are encouraged.
8. Street furniture such as benches, lamps and refuse containers shall be incorporated in the landscape design. These shall be required to be consistent, similar, or identical in character to the architectural character of the development and identified by type and source in the application.
9. Public open space and pedestrian walkway linkages to adjacent neighbourhoods and to Wembley Mall which complement existing parks and recreation opportunities and reduce automobile dependence shall be encouraged.
10. The use of energy efficient building materials, techniques, and practices that reduce the amount of energy consumption shall be encouraged.
11. Comprehensive development proposals that consider the full life cycle of input materials and process by-products as well as seek to minimize energy and raw materials use, minimize waste, and build sustainable economic, ecological and social relationships (eco-industrial networking) shall be encouraged.
12. Buildings shall be designed so as to avoid presenting an overly massive appearance using roof lines, window treatments, and landscaping to break up their bulk and soften their appearance.

Residential Development Guidelines

13. Residential developments should include a variety of housing sizes and types. These may range from single dwelling units, condominiums, and townhouses. Residential land uses should be arranged to achieve gradual transition from adjacent housing types and surrounding neighbourhoods.

5.1.18 Multi Residential, Intensive Residential, Industrial and Commercial Form and Character Development Permit Area

14. Developments should be designed to take advantage of sun exposure to reduce winter heating and summer cooling.
15. Multiple dwelling unit buildings should be designed to utilize sunlight for the health and comfort of residents and for energy conservation purposes.
16. Dwelling units should be designed to allow residents privacy as well as a sense of community such that each unit has at least one private outdoor space with access to or views of adjacent semi-public spaces.
17. Development shall not be a separate "gated community" with walled or fenced enclaves and shall be integrated with and compatible with surrounding neighbourhoods.
18. Where practical, clustering of multi-residential development a minimum of 250 metres away from the centre of the FCPC should be required in order to maximize vegetation retention buffers to limit periodic odour migration.

Parking and Loading

19. Parking and loading areas shall generally be located to the rear of buildings, must be screened from view from adjacent properties, and be located outside of the minimum required zoning setback. The screening should consist of landscaping and/or fencing. Parking areas shall include landscaped areas, defined by concrete curbs, to provide visual breaks between clusters of approximately ten stalls.
20. Vehicular and truck movement patterns must be illustrated on the site plan submitted by the applicant to ensure adequate circulation. A professional engineer may be required to ensure that adequate lane widths and turning radiuses are provided for all forms of vehicles intended to use the property.
21. Provision should be made for emergency vehicles, moving vans, and service vehicles.
22. Safe, efficient, and effectively designed and located roadways, entrance points, parking areas, pedestrian paths, and open spaces shall be provided.

Landscaping and Screening

23. The Regional District shall require the applicant to submit a landscaping plan prepared by a Landscape Architect or equivalent professional which meets the British Columbia Landscape Standard and satisfies the following objectives:
 - a) to use a variety of drought tolerant deciduous and evergreen native plant species that are best suited to the site specific growing conditions;
 - b) to minimize water consumption through means such as micro-irrigation and xeriscaping;
 - c) to provide visual separation from and compatibility with surrounding single residential uses;
 - d) to improve the aesthetic appeal of the development;
 - e) to assist in the safe movement of pedestrians throughout the site;
 - f) to reduce the amount of impervious surfaces on the site;
 - g) to compliment the development and surrounding uses;

5.1.18 Multi Residential, Intensive Residential, Industrial and Commercial Form and Character Development Permit Area

- h) to preserve the rural experience and to minimize the visual distraction of development on Highways No. 19, 19A, and Highway 4; and,
 - i) to establish or enhance habitat values on the development site where appropriate.
- 24. The landscaping plan must be drawn to scale and show the type, size and location of proposed landscaping and shall be submitted with the development permit application.
- 25. At minimum the landscape design should provide a continuous landscaped buffer area of at least 2.0 metres in width along the inside of all property lines, excluding access points, adjacent to all roads and highways and adjacent to all residential zoned property and should contribute towards the objectives identified in Guideline 24.
- 26. Notwithstanding Guideline 24, the landscaped buffer adjacent to any watercourse, coastal area, or environmentally sensitive feature shall be determined by a QEP and shall work towards Guideline 23(i) – to establish or enhance habitat values on the development site.
- 27. To separate parking, service or storage areas from adjacent properties, a landscaped buffer area of at least 2.0 metres in width and 2.0 metres in height, shall be provided along the inside of all affected property lines.
- 28. Buildings and structures should be sited in a manner that minimizes the disturbance of existing native vegetation.
- 29. Vegetation species used in replanting, restoration and enhancement shall be selected to suit the soil, light and groundwater conditions of the site, should be native to the area, and be selected for erosion control and/or fish and habitat wildlife habitat values as needed.
- 30. All replanting shall be maintained by the property owner for a minimum of five years from the date of completion of the planting. Unhealthy, dying or dead stock will be replaced at the owner's expense during the next regular planting season.
- 31. All landscaping shall require the following minimum depth of topsoil or amended organic soils on all landscaped areas of a property:
 - a) shrubs – 45 cm;
 - b) groundcover and grass – 30 cm;
 - c) trees – 30 cm around and below the root ball.
- 32. Where irrigation is required to maintain proposed landscaping, it shall be designed and installed by an Irrigation Industry Association of British Columbia certified irrigation designer.
- 33. The Regional District of Nanaimo shall require the applicant to submit a landscaping and security deposit equal to the total estimated costs of all materials and labour as determined by a Landscape Architect or other similarly qualified person to the satisfaction of the Regional District to be released upon final inspection by a Landscape Architect or other similarly qualified person to the satisfaction of the Regional District of Nanaimo.
- 34. Garbage and recycling containers shall be screened with landscaping and fencing and gated to a minimum height of 2.0 metres. Similarly, utilities, service kiosks, meters, elevator housing, exhaust elements, satellite dishes, etc. shall be screened with landscaping and fencing.

5.1.18 Multi Residential, Intensive Residential, Industrial and Commercial Form and Character Development Permit Area

35. Chain link fencing shall be used only when screened by landscaping. Decorative fences are encouraged matching the materials used for the principle building.
36. Subject to the approval of the MOT where applicable, the installation of boulevards, street trees, pedestrian pathways, or sidewalks within the public road right of way may be supported. Boulevards must be landscaped, irrigated, and maintained by the subject development.
37. Open spaces acting as sites of public assembly shall incorporate special landscape features such as fountains, landscaping or monuments as focal elements.

Site Illumination and Signage:

38. Lighting should be designated for security and safety. However, there should not be glare on neighbouring properties, adjacent roads or the sky.
39. All new, replacement and upgraded exterior lighting in existing and proposed developments shall be Full-Cut Off/Flat Lens (FCO/FL) luminaries to light roads, parking, loading and pedestrian areas. Exterior building lighting will also be required to have FCO lighting fixtures.
40. The size, location and design of freestanding signage shall be architecturally integrated with the overall design of the buildings and landscaping. The design of fascia signs containing individual business signage shall be integrated into the design of the building.
41. No roof top signs shall be permitted. Multi-tenant buildings shall provide combined tenant signage.
42. Signage should be visually unobtrusive; particular emphasis should be given to signage which is aesthetically pleasing and requires a minimal amount of lighting or boldness to be effective

Pedestrian and Cyclist Considerations:

43. Pedestrian sidewalks or defined pathways connecting building entrances to and through parking areas and sidewalks or road right-of-ways of the adjacent streets shall be provided.
44. All internal pedestrian walkways shall be distinguished from driving surfaces through the use of a clearly delineated pathway or durable, low maintenance surface materials such as pavers, bricks, or concrete to enhance pedestrian safety and comfort, as well as the attractiveness of the walkways.
45. Bicycle parking facilities should be provided at grade near the primary building entrances.

5.1.19 Rural Commercial Development Permit Area

Information Note: the designation of this development permit area and description of the special conditions or objectives that justify the designation are located in the Electoral Area H Official Community Plan.

APPLICABILITY

A development permit is required for the following activities wherever they occur within the development permit area, unless specifically exempted:

1. Construction, erection, renovation or addition of buildings or structures on the land, including signage over 1.0 meter in height.
2. Alteration of land, removal of vegetation, disturbance of soils, including grubbing, scraping and removal of top soil.

EXEMPTIONS

The following activities are exempt from any requirement for a development permit:

1. Exemptions listed in Section 8.3 Development Permit Areas – General Exemptions.
2. Construction, renovation, or addition to single dwelling unit, duplex dwelling unit, or accessory residential buildings.
3. Alterations or additions to a building which does not require a building permit. This exemption excludes new signage.
4. Construction of a building or structure with a total floor area of 10 square meters or less which is not visible from a public roadway.
5. Addition to an existing building or structure that is screened from view from a public roadway or other public space by the existing building or structure.
6. Subdivision of land as defined in the *Land Title Act* or *Strata Property Act*.
7. Maintenance of existing landscaping, existing roads, parking areas, paths and trails.
8. Construction of unpaved driveways and walkways not exceeding 4 meters in width.

GUIDELINES

1. The character of the development will generally:
 - a) be designed to utilize the existing topography and vegetation in a manner that is visually unobtrusive and blends into the surrounding landscape,
 - b) be designed to mimic the natural water balance by maximizing infiltration of uncontaminated rainwater,
 - c) integrated with and enhance the character of existing development to avoid mass and character that would be overwhelming to adjacent non-commercial properties, and
 - d) include gathering places such as seating areas, patios, garden entry areas that are visible and accessible and encourage pedestrian uses, where possible.

2. Incorporating natural materials to create a “west coast” style into the design is encouraged.
3. Where buildings present an aspect to the highway or to highly visible areas, continuous blank wall surfaces (longer than 5 meters) shall be avoided. Consider using building articulation, visually-interesting rooflines (e.g., variations in cornice lines and roof slopes); architectural elements (e.g., balconies, bay windows, cupolas, dormers), and other detailing that creates rhythm along the lines of the building.
4. Safe pedestrian and cycling routes that connect the property with the waterfront, open spaces and active transportation networks shall be identified and where applicable, constructed in accordance with the Regional District’s *Community Parks and Trails Strategy, Regional Parks and Trails Plan, or Active Transportation Plan*, and any subsequent editions.
5. Walls, fences, shrubs, grade changes or other site features should not obscure the vision of vehicle drivers with respect to pedestrians or bicycle routes.
6. Off-street parking and off-street loading areas shall be located to the rear of buildings wherever possible, shall be complimentary to the development, and shall be screened with landscaping. Small clustered parking areas are preferable to large paved areas.
7. Off-street parking and off-street loading areas, located adjacent to residential or rural land uses, shall be adequately screened from the residential uses.
8. All outdoor refuse and storage areas shall be screened with a combination of landscape plants and fencing, and wherever possible, located to the rear of the buildings or in unobtrusive locations. For waterfront properties, consideration should also be given to screening these areas from the beach front.
9. For land to be developed where it abuts a residential zoned property(s), a landscaped buffer shall be retained or planted to provide a visual screen.
10. Porous and permeable surfaces should be used where practical and techniques such as rain gardens and vegetative swales to assist in the treatment of rainwater runoff from a site are encouraged in accordance with *Develop with Care: Environmental Guidelines for Urban and Rural Land Development in British Columbia*, published by the B.C. Ministry of Environment, or any subsequent editions. The Regional District may require a rainwater management plan prepared by a Professional Engineer or other qualified professional.
11. Mature trees shall be preserved and, where possible, integrated with new landscaping. The planting of trees is strongly encouraged.
12. Proposed new plantings should consist of indigenous vegetation or other non-invasive vegetation suitable for local environmental conditions.
13. Where the introduction of vegetation is required within the development permit area, the Regional District may require the applicant to submit a landscape plan and security deposit equal to the total estimated costs of all materials and labour as determined by a landscape architect or other qualified professional to the satisfaction of the Regional District.
14. Exterior lighting shall be low intensity, pedestrian-orientated with an emphasis on public safety and the prevention of glare onto adjacent properties, roads or sky. The use of solar power lightening is encouraged.
15. All new or replacement exterior lighting in commercial areas shall use Full-Cut Off/Flat Lens (FCO/FL) lighting fixtures on exterior to light roads, parking, loading and pedestrian areas.

5.1.19 Rural Commercial Development Permit Area

16. Signage should be visually unobtrusive and grouped whenever possible. Particular emphasis should be given to signage that is complementary to the scenic qualities of the area and requires a minimal amount of lighting to be effective. Animated, flashing, oscillating or moving signs and roof top signs shall be avoided to retain a rural appearance and not be distracting to drivers.

5.1.20 Highway Corridor Protection Development Permit Area

Information Note: the designation of this development permit area and description of the special conditions or objectives that justify the designation are located in the Nanoose Bay Official Community Plan.

EXEMPTIONS

The following are exempt from obtaining a development permit:

1. The construction, renovation, or addition to a single dwelling unit, duplex dwelling unit, or accessory residential buildings; and/or
2. The subdivision of land within the ALR.

GUIDELINES

1. Landscaping, screening and the retention of natural vegetation shall be encouraged to enhance the appearance of properties adjacent to the highway in accordance with land use bylaws.
2. Off street parking, loading areas, refuse containers and outdoor storage/manufacturing areas shall, where achievable, be located to the rear of buildings and/or adequately screened from residential and rural lands by a combination of landscape buffering and fencing.
3. Signage on properties bordering the highway should be grouped whenever possible, complementary with the natural character of the area, and employ the use of a minimal amount of direct or indirect lighting to be effective.
4. The Ministry of Transportation and Infrastructure is supported in their initiatives to consolidate access points to major roadways and to provide access through 'slip' roads.

5.1.21 Inland Island Highway Corridor Development Permit Area

Information Note: the designation of this development permit area and description of the special conditions or objectives that justify the designation are located in the Electoral Area G Official Community Plan.

APPLICATION

A development permit is required for the following commercial, industrial, intensive residential and multi-residential uses unless specifically exempt:

1. alteration of land, removal of vegetation, disturbance of soils, including grubbing, scraping, and removal of top soils;
2. construction or erection of buildings and structures;
3. creation of non-structural impervious or semi-pervious surfaces; and
4. Subdivision as defined in the *Land Title Act* or the *Strata Property Act*.

EXEMPTIONS

1. All development activities, including subdivision of land that does not include commercial, industrial, intensive residential or multi-residential development or related activities.

GUIDELINES

1. Development or redevelopment of commercial, industrial, or multi-residential land within the Inland Island Highway Development Permit Area shall:
 - a) reinforce the rural and aesthetic visual image of the Inland Island Highway by maintaining the rural wooded landscape on adjoining lands;
 - b) ensure that orderly and aesthetic development or redevelopment of existing industrial zoned lands do not negatively impact the view corridor of the new highway; and,
 - c) prohibit direct vehicular access from the Inland Island Highway.
2. All industrial, commercial, or multi-residential subdivisions or individual developments should provide a 30 metre visual integrity buffer, adjacent to the Inland Island Highway, where a natural wooded character will be maintained and no buildings, outdoor storage or signage shall be permitted without the approval of both the MOTI and the Regional District Board.
3. Buildings, structures, parking, and storage should be designed and sited to be outside of the visual integrity buffer of the Inland Island Highway and complement the rural integrity of the area. Plans shall be submitted illustrating cross sections of the property and proposed buildings. The Plans shall illustrate the view corridor of eastbound and westbound traffic and the visual impact of any proposed structures from the Inland Island Highway. In addition, a photographic survey of the site and development proposal shall be submitted, from adjoining parcels and major roadways, to illustrate visual compatibility with surrounding development.
4. No signage shall be visible from the Inland Island Highway. Signage should be visually unobtrusive and grouped whenever possible, and no third party signs shall be permitted within the Development Permit Area.

5.1.21 Inland Island Highway Corridor Development Permit Area

5. Wherever possible development should be oriented with the "front" face of buildings away from the Highway and no loading, storage, or other service functions should be located between the building and the highway.
6. Where the introduction of vegetation is required within the Development Permit Area, the Regional District may require the applicant to submit a landscaping and security deposit equal to the total estimated costs of all materials and labour as determined by a landscape architect or other qualified person to the satisfaction of the Regional District.
7. Where irrigation is required to maintain proposed landscaping, it should be designed and installed an Irrigation Industry Association of British Columbia certified irrigation designer.